

Ambient temperature referencing source



Key features:

- Reference radiator with high emissivity ideal for IR camera based fever screening applications
- Integrated 16-bit digital temperature sensor with 0.1 °C accuracy
- Mounting bracket – adjustable for either ceiling or wall mounting
- Plug-and-play installation with 20 m cable and PI 450i suitable PIF-connector

Technical Specifications

Dedicated temperature range	30 °C ... 40 °C
Emissivity	0.95 +/-0.02 (for 8 - 14 µm)
Temperature probe (integrated)	Digital 16-bit temperature sensor
Accuracy of temperature probe	+/-0.1 °C (25 °C ... 50 °C) / drift: 0.0073 °C
Accuracy of PI 450i with BR 20AR (T _{Amb} 18 °C ... 33 °C)	+/-0.5 °C (T _{Obj} 30 °C ... 40 °C)
Interface	5-pin connector fitting to PIF-connector of PI 450i cameras
Dimensions	20 cm x 20 cm 8.2 cm
Weight (with mounting bracket/without cable)	2.5 kg
Scope of supply	<ul style="list-style-type: none"> • BR 20AR radiator • 20 m cable with PIF connector • mounting bracket • operator's manual

Dimensions (in mm)

optris BR 20AR radiator
with bracket for wall mount

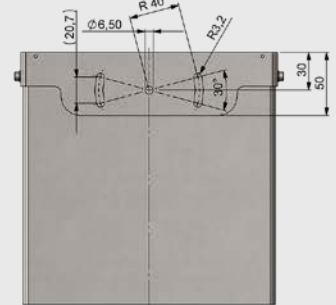
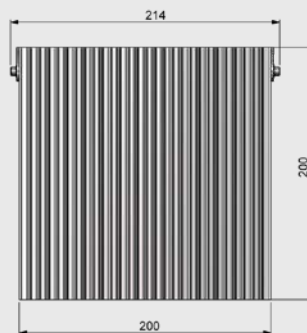
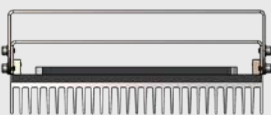

optris BR 20AR radiator
with bracket for ceiling mount

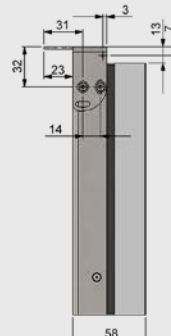
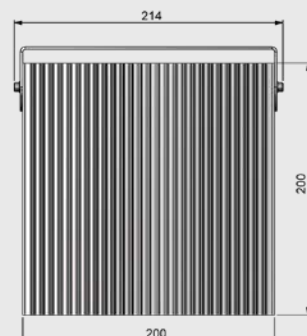
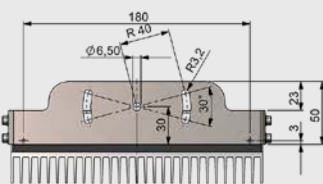

Installation of PI 450i and BR 20AR at an inspection gate for individual fever screening

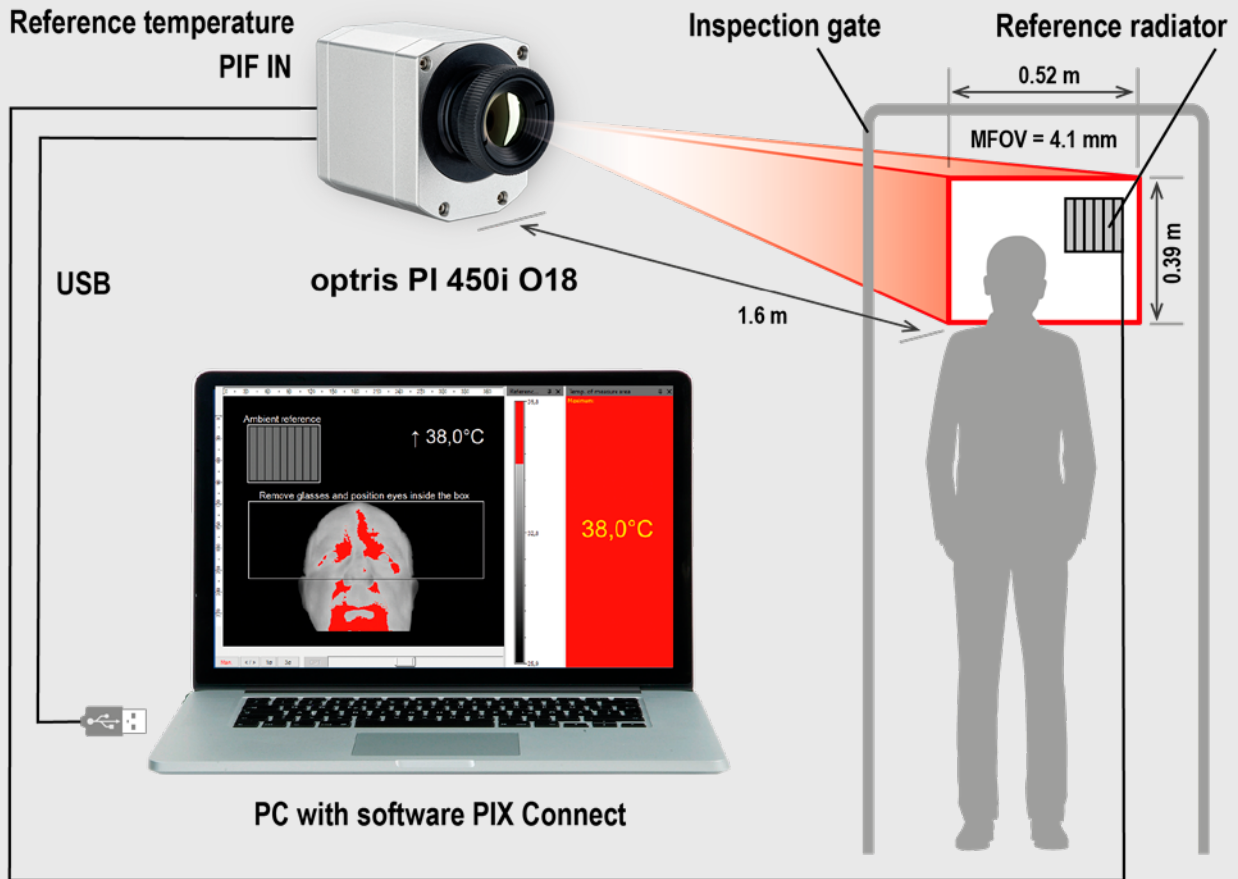

Absolute temperature measurement accuracy

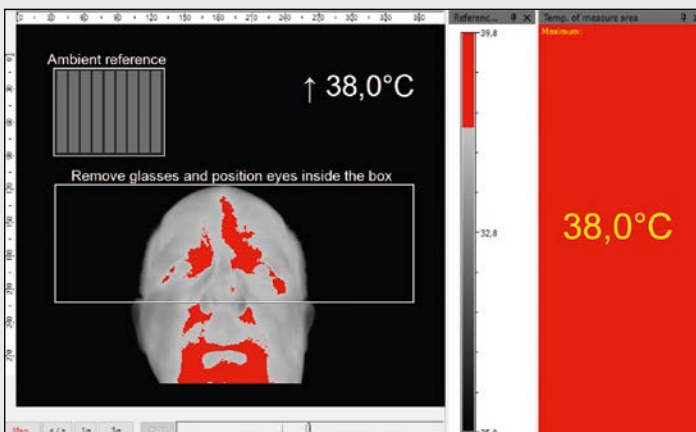

The PIX Connect software is referencing the entire IR image to the known temperature of the Ambient reference which is placed inside the FOV.

To improve the specified camera accuracy of the PI 450i T010 camera a reference source with a high emissivity and a stable and known temperature must be positioned in the scene proximate to the subject to be scanned.

The BR 20AR Ambient referencing source is equipped with a temperature probe with **+/- 0.1 °C** accuracy.

By integrating this highly accurate reference signal to our PIX Connect software, we can reduce camera uncertainties resulting from device adjustment, ambient temperature drift and short term stability down to a system accuracy of **+/- 0.5 °C**.