

Simple access into multiple
sensor installations:
Smart, safe and easy
from -40 to 1030 °C
(-40 to 1886 °F)

Features:

- Temperature range: -40 °C to 1030 °C (-40 °F to 1886 °F)
- Response time: 25 ms
- Optical Resolution: 15:1
- Green LED alarm indication, aiming support, selfdiagnostic or temperature code indication
- Usable up to 80 °C (176 °F) ambient temperature without cooling
- Several outputs selectable: 0–10 V or 0–5 V free scalable or thermocouple type K, alarm output or digital output
- USB programming interface, direct serial 9.6 kBaud interface
- Power supply: 5–30 V DC



General Specifications

Environmental rating	IP 63
Ambient temperature	-20 °C ... 80 °C (-4 °F ... 176 °F)
Storage temperature	-40 °C ... 85 °C (-40 °F ... 185 °F)
Relative humidity	10–95 %, non condensing
Vibration	IEC 68-2-6: 3 G, 11–200 Hz, any axis
Shock	IEC 68-2-27: 50 G, 11 ms, any axis
Weight	58 g (2.0 oz)

Electrical Specifications

Output / analog	Selectable: 0–5 V or 0–10 V free scalable or thermocouple type K/ alarm with adjustable voltage levels
Output / alarm	0–30 V/ 50 mA (open collector)
3-state alarm output	Adjustable threshold values and voltage level for: no alarm, pre-alarm, alarm
Output / digital	Uni/ bidirectional, 9.6 kBaud, 0/3 V digital level/ USB optional
Input (0–10 V)	Programmable functional input for external emissivity setting/ambient temperature adjustment, triggered signal output or peak-hold function
LED-functions	Alarm indication, automatic aiming support, self diagnostic, temperature indication (via. temp.code)
Cable length	1 m (standard), 3 m, 8 m, 15 m (3.3 ft (standard), 9.8 ft, 26.2ft, 49.2ft)
Power supply	5–30 V DC
Current draw	4 mA (without LED)/ 10 mA

Measurement Specifications

Temperature range (scalable via software)	-40 °C ... 1030 °C (-40 °F ... 1886 °F)
Spectral range	8–14 μ m
Optical resolution (90 % energy)	15:1
CF-lens (optional)	0.8 mm @ 10 mm (0.03 in @ 0.4 in)
System accuracy (at ambient temp. 23 ± 5 °C) (23 ± 41 °F)	± 1.5 % or ± 1.5 °C ¹⁾ (± 1.5 % or ± 2.7 °F)
Repeatability (at ambient temp. 23 ± 5 °C) (23 ± 41 °F)	± 0.75 % or ± 0.75 °C ¹⁾ (± 0.75 % or ± 33.4 °F)
Temperature coefficient	± 0.05 K/K or ± 0.05 % / K ³⁾
NETD	0.1 K ²⁾
Response time (90 %)	25 ms (adjustable up to 999 s)
Emissivity/Gain (adjustable via 0–10 V DC input or software)	0.100–1.100
Transmissivity (adjustable via software)	0.100–1.100
Signal processing (parameter adjustable via software)	Peak hold, valley hold, average; extended hold function with threshold and hysteresis
Software	optris® Compact Connect

¹⁾ Object temperature >0 °C (>32 °F); whichever is greater

²⁾ At time constant 100 ms and T_{obj} 25 °C (77 °F)

³⁾ For ambient temperatures <18 °C (<64.4 °F) and >28 °C (>82.4 °F); whichever is greater

Optical Specifications

Optics, D:S = 15:1

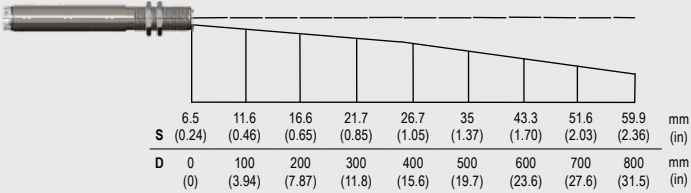

Optics with CF-lens, D:S = 15:1

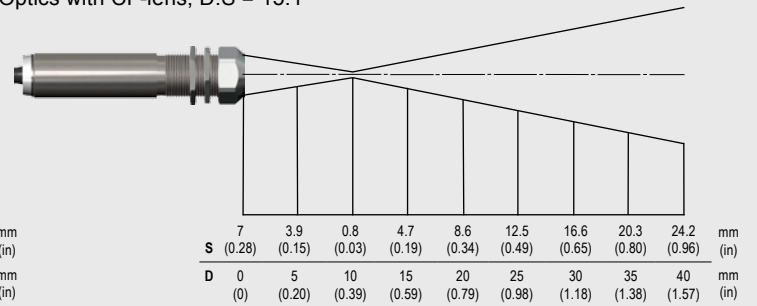

Connections

Connection analog with open collector alarm output (e.g. to actuate a relay)

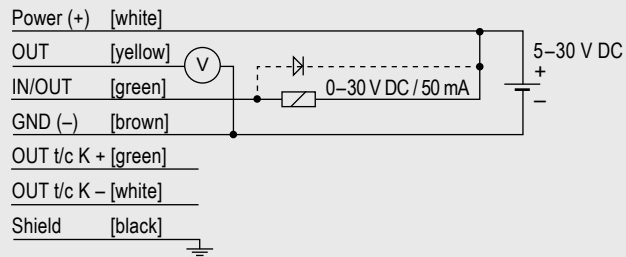

Connection digital with USB adapter cable

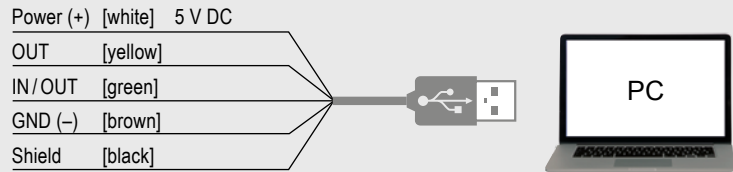

Dimensions/Accessories (examples)

Dimensions optris® CS

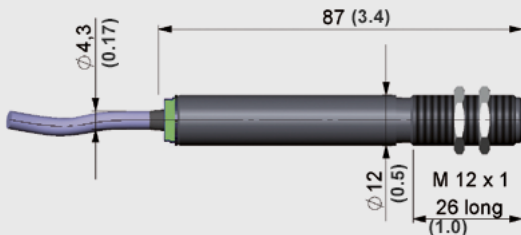

Mounting bracket, fixed (ACCTFB)

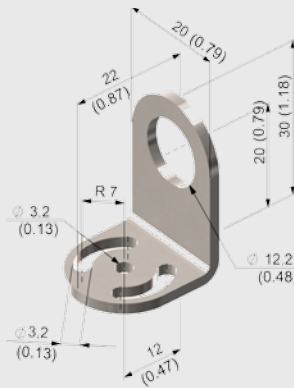

Air purge collar, optional with integrated CF-lens (ACCTAPLCF)

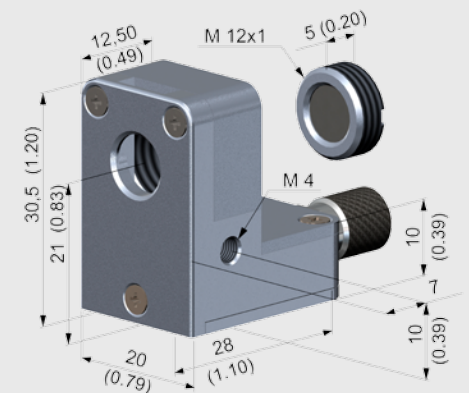

CF-lens (ACCTCF)

