

Linear Patterns (General-Use)

FEATURES

- Gage patterns designed for measuring strain in a single direction
- Single-grid and parallel dual-grid patterns
- Gage lengths from 0.008" (0.20 mm) to 4.000" (101.6 mm)

PATTERNS

015DJ	16
015LW	17
015UW	18
031CE	19
031CF	20
031DE	21
031EC	22
032UW	23
060PB	24
062AK	25
062AP	26
062AQ	27
062DN	28
062ED	29
062EN	30
062LW	31
062UW	32
125AC	33
125AD	34
125BB	35
125BT	36
125BZ	37
125LW	38
125PC	39
125UN	40
125UW	41
187UW	42
250AE	43
250BF	44
250BG	45
250BK	46
250LW	47
250PD	48
250UN	49
250UW	50
375UW	51
500BH	52
500UW	53
10CBE	54
20CBW	55
20CLW	56
Other Linear Patterns	57

General Purpose Strain Gages – Linear Pattern

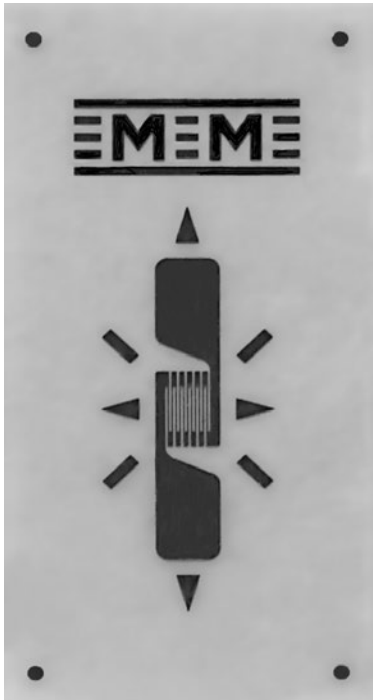
GAGE PATTERN DATA							
	<p>GAGE DESIGNATION See Note 1, 3</p>	<p>RESISTANCE (OHMS) See Note 2</p>	<p>OPTIONS AVAILABLE See Note 3</p>				
	<p>EA-XX-015DJ-120 EP-08-015DJ-120 SA-XX-015DJ-120 SK-XX-015DJ-120</p>	<p>120 ± 0.3% 120 ± 0.3% 120 ± 0.6% 120 ± 0.6%</p>	<p>L, LE</p>				
	<p>DESCRIPTION Micro-miniature pattern with tab at each end of grid. See also 015EH pattern.</p>						
<p>GAGE DIMENSIONS</p>		<p>Legend ES = Each Section CP = Complete Pattern S = Section (S1 = Section 1) M = Matrix</p>					
				<table border="1"> <tr> <td>inch</td> </tr> <tr> <td>millimeter</td> </tr> </table>		inch	millimeter
inch							
millimeter							
Gage Length	Overall Length	Grid Width	Overall Width	Matrix Length	Matrix Width		
0.015	0.100	0.020	0.020	0.23	0.12		
0.38	2.54	0.51	0.51	5.8	3.0		



GAGE SERIES DATA — See Gage Series datasheet for complete specifications			
Series	Description	Strain Range	Temperature Range
EA	Constantan foil in combination with a tough, flexible, polyimide backing.	±3%	-100° to +350°F (-75° to +175°C)
EP	Annealed constantan foil with tough, high-elongation polyimide backing.	±10%	-100° to +400°F (-75° to +205°C)
SA	Fully encapsulated constantan gages with solder dots.	±2%	-100° to +400°F (-75° to +205°C)
SK	Fully encapsulated K-alloy gages with solder dots.	±1.5%	-452° to +450°F (-269° to +230°C)



Note 1: Insert desired S-T-C number in spaces marked XX.

Note 2: Tolerance is increased when Option W, E, SE, LE, or P is specified.

Note 3: Products with designations and options shown in **bold** are not RoHS compliant.



General Purpose Strain Gages – Linear Pattern

GAGE PATTERN DATA					
 <p style="text-align: center;">actual size</p>			GAGE DESIGNATION See Note 1	RESISTANCE (OHMS)	OPTIONS AVAILABLE
			L2A-XX-015LW-120 C2A-XX-015LW-120	120 ± 0.6% 120 ± 0.6%	
DESCRIPTION Widely used general-purpose gage.					
GAGE DIMENSIONS		Legend ES = Each Section CP = Complete Pattern S = Section (S1 = Section 1) M = Matrix			<input type="checkbox"/> inch <input type="checkbox"/> millimeter
Gage Length	Overall Length	Grid Width	Overall Width	Matrix Length	Matrix Width
0.015	0.052	0.020	0.034	0.075	0.054
0.38	1.32	0.50	0.86	1.90	1.37

GAGE SERIES DATA — See Gage Series datasheet for complete specifications			
Series	Description	Strain Range	Temperature Range
C2A	Encapsulated constantan gages with preattached ready-to-use cables.	±3%	-60° to +180°F (-50° to +80°C)
<div style="display: flex; justify-content: space-around; align-items: center;"> <div style="text-align: center;">  <p>Example of an L2A Construction</p> </div> <div style="text-align: center;">  <p>Example of an C2A Construction</p> </div> </div>			

Note 1: Insert desired S-T-C number in spaces marked XX.

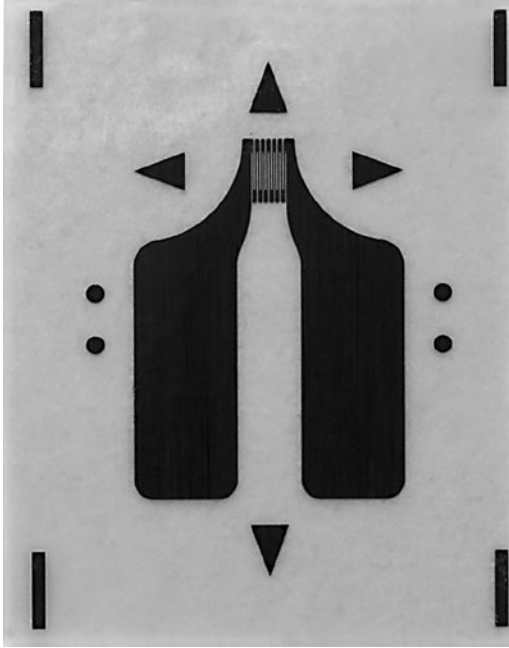
General Purpose Strain Gages – Linear Pattern

GAGE PATTERN DATA					
 <p style="text-align: center;">  actual size </p>			GAGE DESIGNATION See Note 1	RESISTANCE (OHMS) 120 ± 0.3%	OPTIONS AVAILABLE
			CEA-XX-015UW-120		
			DESCRIPTION Micro-miniature pattern. Exposed solder tab area is 0.06 x 0.04 (1.5 x 1.0 mm). See also 015CK pattern		
GAGE DIMENSIONS		Legend ES = Each Section CP = Complete Pattern S = Section (S1 = Section 1) M = Matrix			<input type="checkbox"/> inch <input type="checkbox"/> millimeter
Gage Length	Overall Length	Grid Width	Overall Width	Matrix Length	Matrix Width
0.015	0.140	0.020	0.105	0.24	0.18
0.38	3.56	0.51	2.67	6.1	4.6

GAGE SERIES DATA — See Gage Series datasheet for complete specifications			
Series	Description	Strain Range	Temperature Range
CEA	Universal general-purpose strain gages.	±3%	-100° to +350°F (-75° to +175°C)

Note 1: Insert desired S-T-C number in spaces marked XX.

General Purpose Strain Gages—Linear Pattern

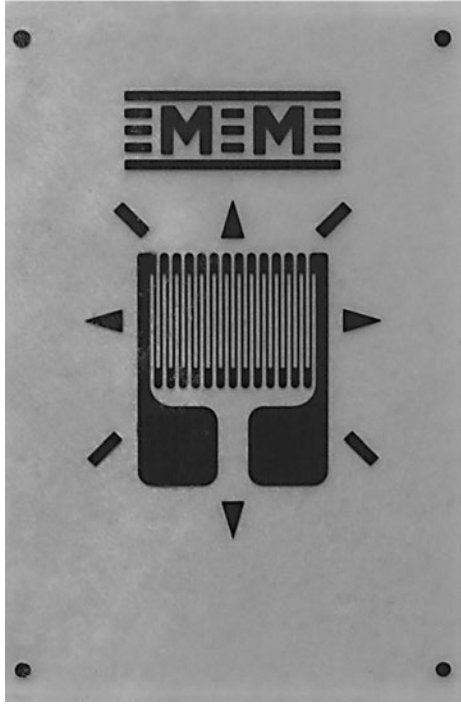
GAGE PATTERN DATA					
 <p>actual size</p>		GAGE DESIGNATION See Note 1, 3	RESISTANCE (OHMS) See Note 2	OPTIONS AVAILABLE See Note 3	
		EA-XX-031CE-350 WA-XX-031CE-350 EP-XX-031CE-350 SA-XX-031CE-350	350 ± 0.2% 350 ± 0.4% 350 ± 0.2% 350 ± 0.4%	W, E, L, LE, P	
DESCRIPTION General-purpose high-resistance miniature gage.					
GAGE DIMENSIONS		Legend ES = Each Section CP = Complete Pattern S = Section (S1 = Section 1) M = Matrix			
				inch	
				millimeter	
Gage Length	Overall Length	Grid Width	Overall Width	Matrix Length	Matrix Width
0.031	0.076	0.062	0.062	0.23	0.16
0.79	1.93	1.57	1.57	5.8	4.1

GAGE SERIES DATA — See Gage Series datasheet for complete specifications			
Series	Description	Strain Range	Temperature Range
EA	Constantan foil in combination with a tough, flexible, polyimide backing.	±3%	-100° to +350°F (-75° to +175°C)
WA	Fully encapsulated constantan gages with high-endurance leadwires.	±2%	-100° to +400°F (-75° to +205°C)
EP	Annealed constantan foil with tough, high-elongation polyimide backing.	±10%	-100° to +400°F (-75° to +205°C)
SA	Fully encapsulated constantan gages with solder dots.	±2%	-100° to +400°F (-75° to +205°C)

Note 1: Insert desired S-T-C number in spaces marked XX.

Note 2: Tolerance is increased when Option W, E, SE, LE, or P is specified.

Note 3: Products with designations and options shown in **bold** are not RoHS compliant.

General Purpose Strain Gages—Linear Pattern

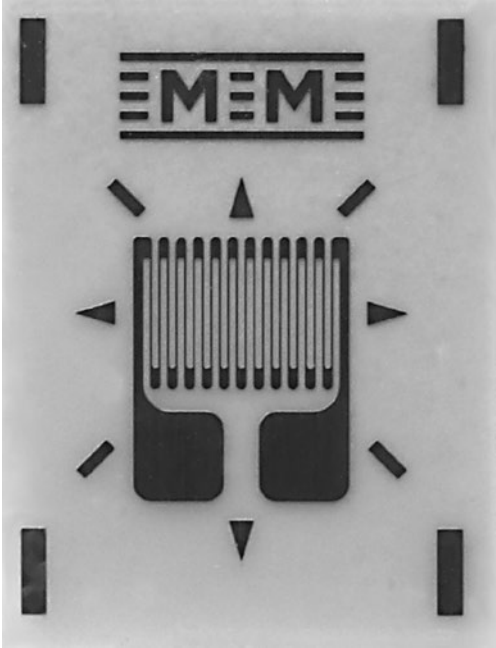
GAGE PATTERN DATA							
 <p>actual size</p>		GAGE DESIGNATION See Note 1, 3	RESISTANCE (OHMS) See Note 2	OPTIONS AVAILABLE See Note 3			
		EA-XX-031CF-120 ED-DY-031CF-350 WA-XX-031CF-120 WK-XX-031CF-350 EP-08-031CF-120 SA-XX-031CF-120 SK-XX-031CF-120 SK-XX-031CF-350 SD-DY-031CF-350	120 ± 0.2% 350 ± 0.4% 120 ± 0.4% 350 ± 0.4% 120 ± 0.2% 120 ± 0.4% 120 ± 0.4% 350 ± 0.4% 350 ± 0.8%	W, E, L, LE, P E, L*, LE*			
DESCRIPTION General-purpose miniature gage. Similar to 031CE pattern except for resistance. See also 032UW pattern.							
GAGE DIMENSIONS		Legend ES = Each Section CP = Complete Pattern S = Section (S1 = Section 1) M = Matrix					
				<table border="1"> <tr><td>inch</td></tr> <tr><td>millimeter</td></tr> </table>		inch	millimeter
inch							
millimeter							
Gage Length	Overall Length	Grid Width	Overall Width	Matrix Length	Matrix Width		
0.031	0.076	0.062	0.062	0.19	0.14		
0.79	1.93	1.57	1.57	4.8	3.5		

GAGE SERIES DATA — See Gage Series datasheet for complete specifications			
Series	Description	Strain Range	Temperature Range
EA	Constantan foil in combination with a tough, flexible, polyimide backing.	±3%	-100° to +350°F (-75° to +175°C)
ED	Isoelastic foil in combination with tough, flexible polyimide film.	±2%	-320° to +400°F (-195° to +205°C)
WA	Fully encapsulated constantan gages with high-endurance leadwires.	±2%	-100° to +400°F (-75° to +205°C)
WK	Fully encapsulated K-alloy gages with high-endurance leadwires.	±1.5%	-452° to +550°F (-269° to +290°C)
EP	Annealed constantan foil with tough, high-elongation polyimide backing.	±10%	-100° to +400°F (-75° to +205°C)
SA	Fully encapsulated constantan gages with solder dots.	±2%	-100° to +400°F (-75° to +205°C)
SK	Fully encapsulated K-alloy gages with solder dots.	±1.5%	-452° to +450°F (-269° to +230°C)
SD	Equivalent to WD Series, but with solder dots instead of leadwires.	±1.5%	-320° to +400°F (-195° to +205°C)

Note 1: Insert desired S-T-C number in spaces marked XX.

Note 2: Tolerance is increased when Option W, E, SE, LE, or P is specified.

Note 3: Products with designations and options shown in **bold** are not RoHS compliant.

*Options available but not normally recommended. See Optional Features data sheet for details.

General Purpose Strain Gages – Linear Pattern

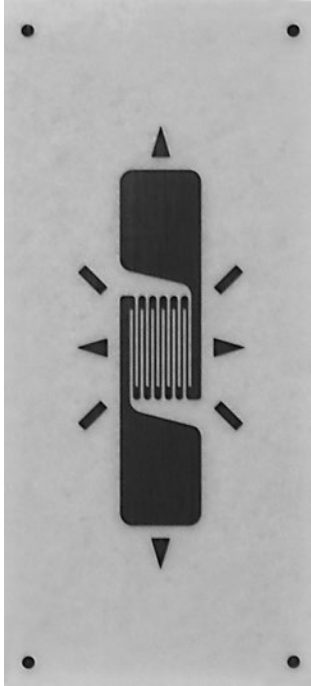
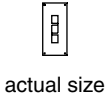
GAGE PATTERN DATA					
		GAGE DESIGNATION See Note 1, 3		RESISTANCE (OHMS) See Note 2	OPTIONS AVAILABLE See Note 3
		EA-XX-031DE-120 EA-XX-031DE-350 ED-DY-031DE-350 WA-XX-031DE-120 WA-XX-031DE-350 WK-XX-031DE-350 EP-XX-031DE-120 SA-XX-031DE-350 SA-XX-031DE-350 SK-XX-031DE-120 SK-XX-031DE-350 SD-DY-031DE-350		120 ± 0.2% 350 ± 0.2% 350 ± 0.4% 120 ± 0.4% 350 ± 0.4% 350 ± 0.4% 120 ± 0.2% 350 ± 0.4% 350 ± 0.4% 120 ± 0.4% 350 ± 0.4% 350 ± 0.8%	E, SE , L, LE E, SE , L, LE E, L*, LE*
				DESCRIPTION General-purpose miniature gage.	
GAGE DIMENSIONS			Legend ES = Each Section CP = Complete Pattern S = Section (S1 = Section 1) M = Matrix		
		inch			
		millimeter			
Gage Length	Overall Length	Grid Width	Overall Width	Matrix Length	Matrix Width
0.031	0.140	0.032	0.032	0.27	0.12
0.79	3.56	0.81	0.81	6.9	3.0

GAGE SERIES DATA — See Gage Series datasheet for complete specifications			
Series	Description	Strain Range	Temperature Range
EA	Constantan foil in combination with a tough, flexible, polyimide backing.	±3%	-100° to +350°F (-75° to +175°C)
ED	Isoelastic foil in combination with tough, flexible polyimide film.	±2%	-320° to +400°F (-195° to +205°C)
WA	Fully encapsulated constantan gages with high-endurance leadwires.	±2%	-100° to +400°F (-75° to +205°C)
WK	Fully encapsulated K-alloy gages with high-endurance leadwires.	±1.5%	-452° to +550°F (-269° to +290°C)
EP	Annealed constantan foil with tough, high-elongation polyimide backing.	±10%	-100° to +400°F (-75° to +205°C)
SA	Fully encapsulated constantan gages with solder dots.	±2%	-100° to +400°F (-75° to +205°C)
SK	Fully encapsulated K-alloy gages with solder dots.	±1.5%	-452° to +450°F (-269° to +230°C)
SD	Equivalent to WD Series, but with solder dots instead of leadwires.	±1.5%	-320° to +400°F (-195° to +205°C)



Note 1: Insert desired S-T-C number in spaces marked XX.

Note 2: Tolerance is increased when Option W, E, SE, LE, or P is specified.

Note 3: Products with designations and options shown in **bold** are not RoHS compliant.

*Options available but not normally recommended. See Optional Features data sheet for details.

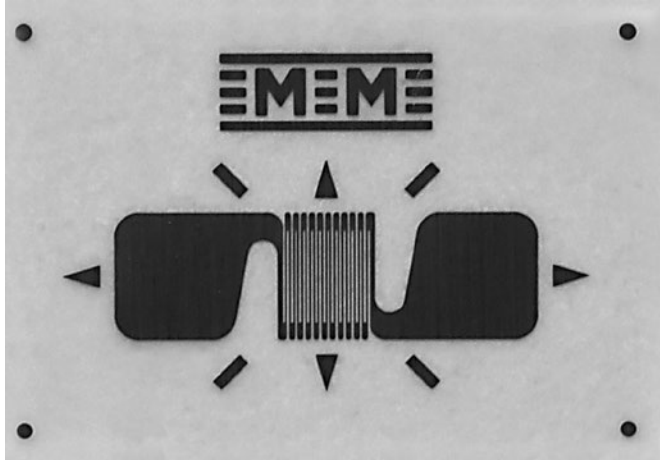
General Purpose Strain Gages—Linear Pattern

GAGE PATTERN DATA						
		GAGE DESIGNATION See Note 1, 3	RESISTANCE (OHMS) See Note 2	OPTIONS AVAILABLE See Note 3		
		EA-XX-031EC-120 EA-XX-031EC-350 ED-DY-031EC-350 WA-XX-031EC-120 WA-XX-031EC-350 WK-XX-031EC-350 EP-08-031EC-120 SA-XX-031EC-120 SA-XX-031EC-350 SK-XX-031EC-120 SK-XX-031EC-350 SD-DY-031EC-350	120 ± 0.2% 350 ± 0.2% 350 ± 0.4% 120 ± 0.4% 350 ± 0.4% 350 ± 0.4% 120 ± 0.2% 120 ± 0.4% 350 ± 0.4% 120 ± 0.4% 350 ± 0.4% 350 ± 0.8%	E, SE , L, LE E, SE , L, LE E, L*, LE*		
 actual size		DESCRIPTION General-purpose miniature gage. Similar to 031DE pattern but with tab at each side of grid.				
GAGE DIMENSIONS		Legend ES = Each Section S = Section (S1 = Section 1)			CP = Complete Pattern M = Matrix	<input type="checkbox"/> inch <input type="checkbox"/> millimeter
Gage Length	Overall Length	Grid Width	Overall Width	Matrix Length	Matrix Width	
0.031	0.042	0.032	0.140	0.17	0.23	
0.79	1.07	0.81	3.56	4.3	5.8	

GAGE SERIES DATA — See Gage Series datasheet for complete specifications			
Series	Description	Strain Range	Temperature Range
EA	Constantan foil in combination with a tough, flexible, polyimide backing.	±3%	-100° to +350°F (-75° to +175°C)
ED	Isoelastic foil in combination with tough, flexible polyimide film.	±2%	-320° to +400°F (-195° to +205°C)
WA	Fully encapsulated constantan gages with high-endurance leadwires.	±2%	-100° to +400°F (-75° to +205°C)
WK	Fully encapsulated K-alloy gages with high-endurance leadwires.	±1.5%	-452° to +550°F (-269° to +290°C)
EP	Annealed constantan foil with tough, high-elongation polyimide backing.	±10%	-100° to +400°F (-75° to +205°C)
SA	Fully encapsulated constantan gages with solder dots.	±2%	-100° to +400°F (-75° to +205°C)
SK	Fully encapsulated K-alloy gages with solder dots.	±1.5%	-452° to +450°F (-269° to +230°C)
SD	Equivalent to WD Series, but with solder dots instead of leadwires.	±1.5%	-320° to +400°F (-195° to +205°C)

Note 1: Insert desired S-T-C number in spaces marked XX.

Note 2: Tolerance is increased when Option W, E, SE, LE, or P is specified.

Note 3: Products with designations and options shown in **bold** are not RoHS compliant.

*Options available but not normally recommended. See Optional Features data sheet for details.

General Purpose Strain Gages – Linear Pattern

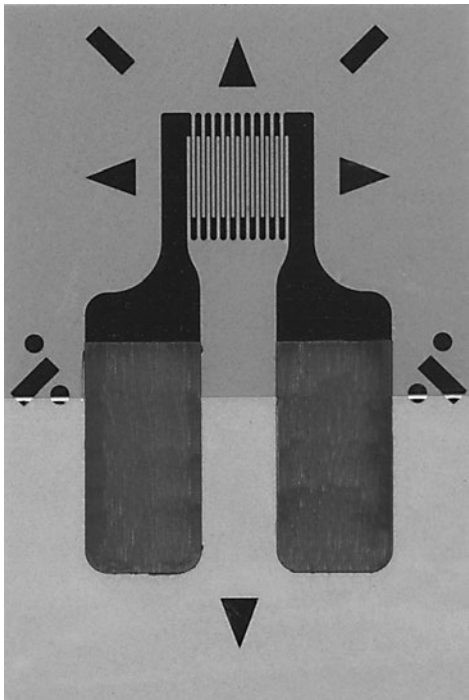

GAGE PATTERN DATA					
 <p>actual size</p>		GAGE DESIGNATION See Note 1	RESISTANCE (OHMS)	OPTIONS AVAILABLE See Note 2	
		CEA-XX-032UW-120 CEA-XX-032UW-350	120 ± 0.3% 350 ± 0.3%	P2 P2	
DESCRIPTION General-purpose miniature gage. Exposed solder tab area is 0.07 x 0.04 in [1.8 x 1.0 mm].					
GAGE DIMENSIONS		Legend ES = Each Section CP = Complete Pattern S = Section (S1 = Section 1) M = Matrix			
					<input type="checkbox"/> inch <input type="checkbox"/> millimeter
Gage Length	Overall Length	Grid Width	Overall Width	Matrix Length	Matrix Width
0.032	0.180	0.060	0.120	0.27	0.19
0.81	4.57	1.52	3.05	6.9	4.8

GAGE SERIES DATA — See Gage Series datasheet for complete specifications			
Series	Description	Strain Range	Temperature Range
CEA	Universal general-purpose strain gages.	±3%	-100° to +350°F (-75° to +175°C)

Note 1: Insert desired S-T-C number in spaces marked XX.

Note 2: Products with designations and options shown in **bold** are not RoHS compliant.

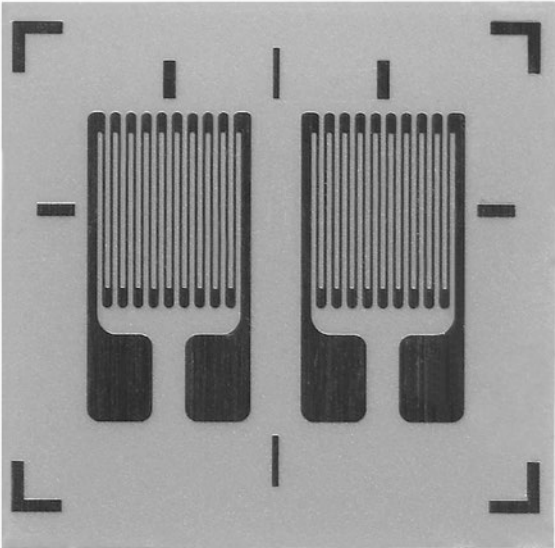
General Purpose Strain Gages – Linear Pattern

GAGE PATTERN DATA					
 <p style="text-align: center;">  actual size </p>			GAGE DESIGNATION See Note 1, 3	RESISTANCE (OHMS) See Note 2	OPTIONS AVAILABLE See Note 3
			EA-XX-060PB-120 EA-XX-060PB-350 WA-XX-060PB-120 WA-XX-060PB-350 WK-XX-060PB-350 WK-XX-060PB-500 SA-XX-060PB-120 SA-XX-060PB-350 SK-XX-060PB-350 SK-XX-060PB-500	120 ± 0.2% 350 ± 0.2% 120 ± 0.3% 350 ± 0.3% 350 ± 0.3% 500 ± 0.3% 120 ± 0.3% 350 ± 0.3% 350 ± 0.3% 500 ± 0.3%	W, E, L, LE W, E, L, LE W* W* W* W*
DESCRIPTION Dual pattern for back-to-back bending sections. Longitudinal grid centerlines spaced 0.085 in (2.16 mm) apart.					
GAGE DIMENSIONS		Legend ES = Each Section CP = Complete Pattern S = Section (S1 = Section 1) M = Matrix			
				<input type="checkbox"/> inch <input type="checkbox"/> millimeter	
Gage Length	Overall Length	Grid Width	Overall Width	Matrix Length	Matrix Width
0.060 ES	0.120 CP	0.065 ES	0.150 CP	0.18	0.20
1.52 ES	3.05 CP	1.65 ES	3.81 CP	4.6	5.1

GAGE SERIES DATA — See Gage Series datasheet for complete specifications				
Series	Description	Strain Range	Temperature Range	
EA	Constantan foil in combination with a tough, flexible, polyimide backing.	±3%	-100° to +350°F (-75° to +175°C)	
WA	Fully encapsulated constantan gages with high-endurance leadwires.	±2%	-100° to +400°F (-75° to +205°C)	
WK	Fully encapsulated K-alloy gages with high-endurance leadwires.	±1.5%	-452° to +550°F (-269° to +290°C)	
SA	Fully encapsulated constantan gages with solder dots.	±2%	-100° to +400°F (-75° to +205°C)	
SK	Fully encapsulated K-alloy gages with solder dots.	±1.5%	-452° to +450°F (-269° to +230°C)	



Note 1: Insert desired S-T-C number in spaces marked XX.

Note 2: Tolerance is increased when Option W, E, SE, LE, or P is specified.

Note 3: Products with designations and options shown in **bold** are not RoHS compliant.

*Options available but not normally recommended. See Optional Features data sheet for details.

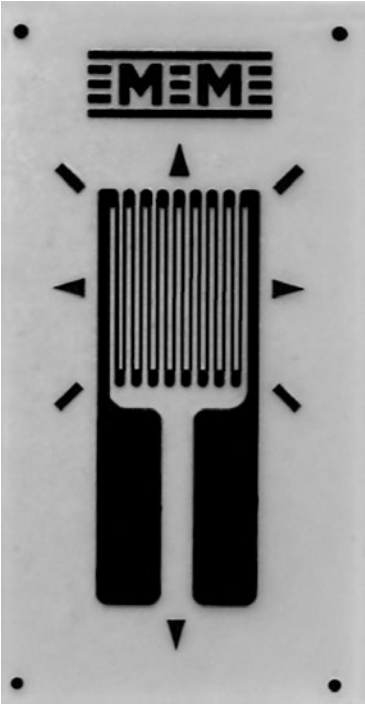
General Purpose Strain Gages – Linear Pattern

GAGE PATTERN DATA						
		<p>GAGE DESIGNATION See Note 1</p>		<p>RESISTANCE (OHMS) See Note 2</p>	<p>OPTIONS AVAILABLE See Note 3</p>	
		<p>EA-XX-062AK-120 ED-DY-062AK-350 EP-08-062AK-120</p>		<p>120 ± 0.15% 350 ± 0.4% 120 ± 0.15%</p>	<p>E, P E</p>	
 <p>actual size</p>		<p>DESCRIPTION</p> <p>General-purpose gage with elongated solder tabs. See the 062AP pattern for WA, WK, and other series with this grid size.</p>				
		<p>GAGE DIMENSIONS</p>		<p>Legend ES = Each Section CP = Complete Pattern S = Section (S1 = Section 1) M = Matrix</p>		<table border="1"> <tr> <td>inch</td> </tr> <tr> <td>millimeter</td> </tr> </table>
inch						
millimeter						
Gage Length	Overall Length	Grid Width	Overall Width	Matrix Length	Matrix Width	
0.062	0.160	0.062	0.062	0.27	0.14	
1.57	4.06	1.57	1.57	6.9	3.6	

GAGE SERIES DATA — See Gage Series datasheet for complete specifications			
Series	Description	Strain Range	Temperature Range
EA	Constantan foil in combination with a tough, flexible, polyimide backing.	±3%	-100° to +350°F (-75° to +175°C)
ED	Isoelastic foil in combination with tough, flexible polyimide film.	±2%	-320° to +400°F (-195° to +205°C)
EP	Annealed constantan foil with tough, high-elongation polyimide backing.	±10%	-100° to +400°F (-75° to +205°C)

Note 1: Insert desired S-T-C number in spaces marked XX.

Note 2: Tolerance is increased when Option W, E, SE, LE, or P is specified.

Note 3: Products with designations and options shown in **bold** are not RoHS compliant.

General Purpose Strain Gages – Linear Pattern

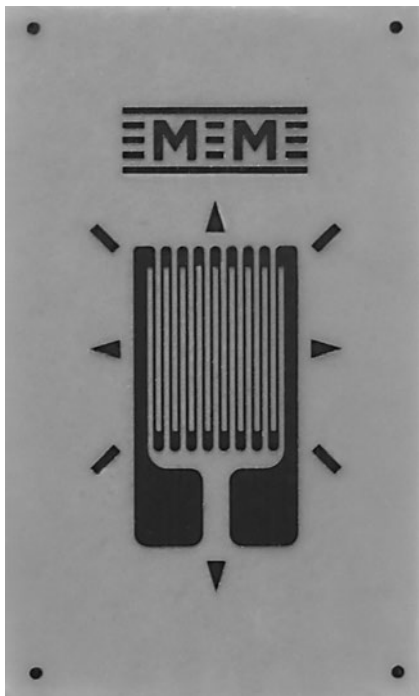
GAGE PATTERN DATA					
 <p style="text-align: center;">actual size</p>		GAGE DESIGNATION See Note 1, 3	RESISTANCE (OHMS) See Note 2	OPTIONS AVAILABLE See Note 3	
		EA-XX-062AP-120 ED-DY-062AP-350 EK-XX-062AP-350 WA-XX-062AP-120 WK-XX-062AP-350 EP-XX-062AP-120 SA-XX-062AP-120 SK-XX-062AP-350 SD-DY-062AP-350 WD-DY-062AP-350	120 ± 0.15% 350 ± 0.4% 350 ± 0.15% 120 ± 0.3% 350 ± 0.3% 120 ± 0.15% 120 ± 0.3% 350 ± 0.3% 350 ± 0.8% 350 ± 0.8%	W, E, L, LE, P E, L*, LE* W, SE W* W*	
DESCRIPTION Widely used general-purpose gage. See also 062UW pattern. EK-Series gages are supplied with duplex copper pads (DP) when optional feature W or SE is not specified.					
GAGE DIMENSIONS		Legend ES = Each Section CP = Complete Pattern S = Section (S1 = Section 1) M = Matrix			<input type="checkbox"/> inch <input type="checkbox"/> millimeter
Gage Length	Overall Length	Grid Width	Overall Width	Matrix Length	Matrix Width
0.062	0.114	0.062	0.062	0.26	0.16
1.57	2.90	1.57	1.57	6.6	4.1

GAGE SERIES DATA — See Gage Series datasheet for complete specifications			
Series	Description	Strain Range	Temperature Range
EA	Constantan foil in combination with a tough, flexible, polyimide backing.	±3%	-100° to +350°F (-75° to +175°C)
ED	Isoelastic foil in combination with tough, flexible polyimide film.	±2%	-320° to +400°F (-195° to +205°C)
EK	K-alloy foil in combination with a tough, flexible polyimide backing.	±1.5%	-320° to +350°F (-195° to +175°C)
WA	Fully encapsulated constantan gages with high-endurance leadwires.	±2%	-100° to +400°F (-75° to +205°C)
WK	Fully encapsulated K-alloy gages with high-endurance leadwires.	±1.5%	-452° to +550°F (-269° to +290°C)
EP	Annealed constantan foil with tough, high-elongation polyimide backing.	±10%	-100° to +400°F (-75° to +205°C)
SA	Fully encapsulated constantan gages with solder dots.	±2%	-100° to +400°F (-75° to +205°C)
SK	Fully encapsulated K-alloy gages with solder dots.	±1.5%	-452° to +450°F (-269° to +230°C)
SD	Equivalent to WD Series, but with solder dots instead of leadwires.	±1.5%	-320° to +400°F (-195° to +205°C)
WD	Fully encapsulated isoelastic gages with high-endurance leadwires.	±1.5%	-320° to +500°F (-195° to +260°C)

Note 1: Insert desired S-T-C number in spaces marked XX.

Note 2: Tolerance is increased when Option W, E, SE, LE, or P is specified.

Note 3: Products with designations and options shown in **bold** are not RoHS compliant.

*Options available but not normally recommended. See Optional Features data sheet for details.

General Purpose Strain Gages – Linear Pattern

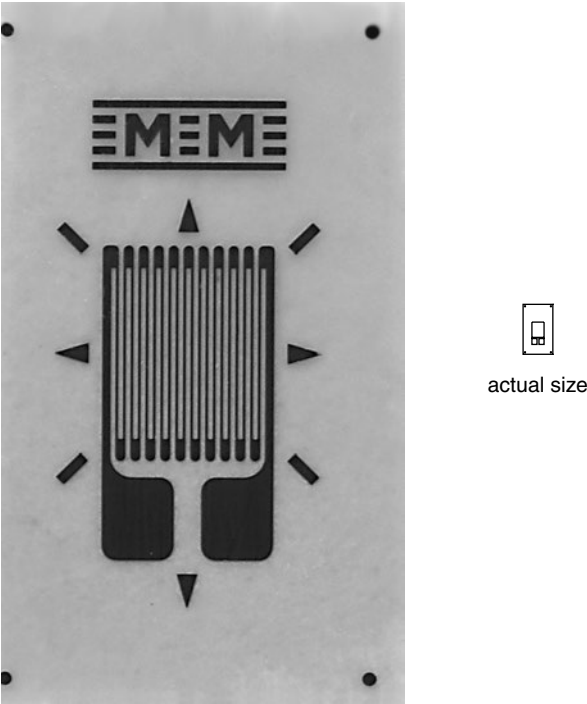
GAGE PATTERN DATA					
		GAGE DESIGNATION See Note 1, 3	RESISTANCE (OHMS) See Note 2	OPTIONS AVAILABLE See Note 3	
		EA-XX-062AQ-350 ED-DY-062AQ-500 WA-XX-062AQ-350 WK-XX-062AQ-500 EP-08-062AQ-350 SA-XX-062AQ-350 SK-XX-062AQ-500 SD-DY-062AQ-500 WD-DY-062AQ-500	350 ± 0.15% 500 ± 0.4% 350 ± 0.3% 500 ± 0.3% 350 ± 0.15% 350 ± 0.3% 500 ± 0.3% 500 ± 0.8% 500 ± 0.8%	W, E, L, LE, P E, L*, LE* W* W*	
DESCRIPTION General-purpose gage. Similar to 062AP pattern but with high-resistance grid. See also 062UW pattern.					
GAGE DIMENSIONS		Legend ES = Each Section CP = Complete Pattern S = Section (S1 = Section 1) M = Matrix			
				inch	
				millimeter	
Gage Length	Overall Length	Grid Width	Overall Width	Matrix Length	Matrix Width
0.062	0.114	0.062	0.062	0.26	0.15
1.57	2.90	1.57	1.57	6.6	3.8

GAGE SERIES DATA — See Gage Series datasheet for complete specifications			
Series	Description	Strain Range	Temperature Range
EA	Constantan foil in combination with a tough, flexible, polyimide backing.	±3%	-100° to +350°F (-75° to +175°C)
ED	Isoelastic foil in combination with tough, flexible polyimide film.	±2%	-320° to +400°F (-195° to +205°C)
WA	Fully encapsulated constantan gages with high-endurance leadwires.	±2%	-100° to +400°F (-75° to +205°C)
WK	Fully encapsulated K-alloy gages with high-endurance leadwires.	±1.5%	-452° to +550°F (-269° to +290°C)
EP	Annealed constantan foil with tough, high-elongation polyimide backing.	±10%	-100° to +400°F (-75° to +205°C)
SA	Fully encapsulated constantan gages with solder dots.	±2%	-100° to +400°F (-75° to +205°C)
SK	Fully encapsulated K-alloy gages with solder dots.	±1.5%	-452° to +450°F (-269° to +230°C)
SD	Equivalent to WD Series, but with solder dots instead of leadwires.	±1.5%	-320° to +400°F (-195° to +205°C)
WD	Fully encapsulated isoelastic gages with high-endurance leadwires.	±1.5%	-320° to +500°F (-195° to +260°C)

Note 1: Insert desired S-T-C number in spaces marked XX.

Note 2: Tolerance is increased when Option W, E, SE, LE, or P is specified.

Note 3: Products with designations and options shown in **bold** are not RoHS compliant.

*Options available but not normally recommended. See Optional Features data sheet for details.

General Purpose Strain Gages – Linear Pattern

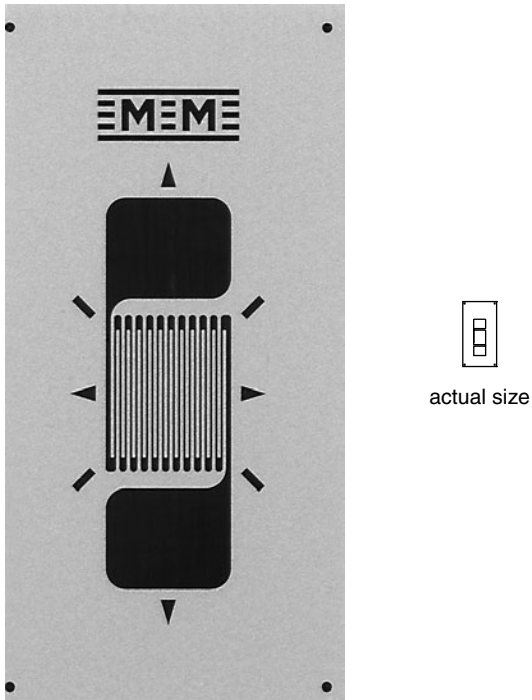
GAGE PATTERN DATA							
		GAGE DESIGNATION See Note 1, 3	RESISTANCE (OHMS) See Note 2	OPTIONS AVAILABLE See Note 3			
		EA-XX-062DN-350 ED-DY-062DN-500 WA-XX-062DN-350 WK-XX-062DN-500 EP-08-062DN-350 SA-XX-062DN-350 SK-XX-062DN-500 SD-DY-062DMN-500 WD-DY-062DN-500	350 ± 0.15% 500 ± 0.4% 350 ± 0.3% 500 ± 0.3% 350 ± 0.15% 350 ± 0.3% 500 ± 0.3% 500 ± 0.8% 500 ± 0.8%	E, L, LE E, L*, LE*			
<p style="text-align: center;">DESCRIPTION</p> <p style="text-align: center;">Similar to 062DF pattern except for grid resistance.</p>							
GAGE DIMENSIONS		Legend					
		ES = Each Section S = Section (S1 = Section 1)		CP = Complete Pattern M = Matrix			
		<table border="1" style="display: inline-table; border-collapse: collapse;"> <tr><td style="padding: 2px;">inch</td></tr> <tr><td style="padding: 2px;">millimeter</td></tr> </table>				inch	millimeter
inch							
millimeter							
Gage Length	Overall Length	Grid Width	Overall Width	Matrix Length	Matrix Width		
0.062	0.190	0.062	0.062	0.34	0.18		
1.57	4.83	1.57	1.57	8.6	4.6		

GAGE SERIES DATA — See Gage Series datasheet for complete specifications			
Series	Description	Strain Range	Temperature Range
EA	Constantan foil in combination with a tough, flexible, polyimide backing.	±3%	-100° to +350°F (-75° to +175°C)
ED	Isoelastic foil in combination with tough, flexible polyimide film.	±2%	-320° to +400°F (-195° to +205°C)
WA	Fully encapsulated constantan gages with high-endurance leadwires.	±2%	-100° to +400°F (-75° to +205°C)
WK	Fully encapsulated K-alloy gages with high-endurance leadwires.	±1.5%	-452° to +550°F (-269° to +290°C)
EP	Annealed constantan foil with tough, high-elongation polyimide backing.	±10%	-100° to +400°F (-75° to +205°C)
SA	Fully encapsulated constantan gages with solder dots.	±2%	-100° to +400°F (-75° to +205°C)
SK	Fully encapsulated K-alloy gages with solder dots.	±1.5%	-452° to +450°F (-269° to +230°C)
SD	Equivalent to WD Series, but with solder dots instead of leadwires.	±1.5%	-320° to +400°F (-195° to +205°C)
WD	Fully encapsulated isoelastic gages with high-endurance leadwires.	±1.5%	-320° to +500°F (-195° to +260°C)



Note 1: Insert desired S-T-C number in spaces marked XX.

Note 2: Tolerance is increased when Option W, E, SE, LE, or P is specified.

Note 3: Products with designations and options shown in **bold** are not RoHS compliant.

*Options available but not normally recommended. See Optional Features data sheet for details.

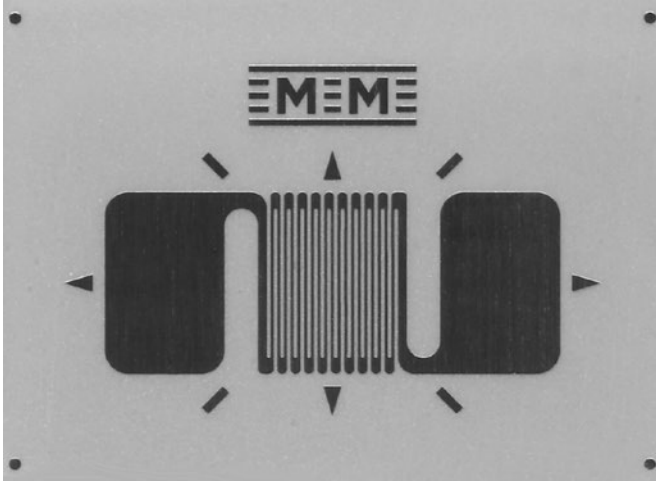
General Purpose Strain Gages – Linear Pattern

GAGE PATTERN DATA						
   actual size		GAGE DESIGNATION See Note 1, 3	RESISTANCE (OHMS) See Note 2	OPTIONS AVAILABLE See Note 3		
		EA-XX-062ED-120 ED-DY-062ED-350 WA-XX-062ED-120 WK-XX-062ED-350 EP-08-062ED-120 SA-XX-062ED-350 SK-XX-062ED-350 SD-DY-062ED-350 WD-DY-062ED-350	120 ± 0.15% 350 ± 0.4% 120 ± 0.3% 350 ± 0.3% 120 ± 0.15% 120 ± 0.3% 350 ± 0.3% 350 ± 0.8% 350 ± 0.8%	E, L, LE E, L*, LE**		
DESCRIPTION General-purpose gage. Similar to 062EN pattern except for grid resistance.						
GAGE DIMENSIONS		Legend ES = Each Section S = Section (S1 = Section 1)			CP = Complete Pattern M = Matrix	inch millimeter
Gage Length	Overall Length	Grid Width	Overall Width	Matrix Length	Matrix Width	
0.062	0.076	0.062	0.190	0.21	0.29	
1.57	1.93	1.57	4.83	5.3	7.4	

GAGE SERIES DATA — See Gage Series datasheet for complete specifications			
Series	Description	Strain Range	Temperature Range
EA	Constantan foil in combination with a tough, flexible, polyimide backing.	±3%	-100° to +350°F (-75° to +175°C)
ED	Isoelastic foil in combination with tough, flexible polyimide film.	±2%	-320° to +400°F (-195° to +205°C)
WA	Fully encapsulated constantan gages with high-endurance leadwires.	±2%	-100° to +400°F (-75° to +205°C)
WK	Fully encapsulated K-alloy gages with high-endurance leadwires.	±1.5%	-452° to +550°F (-269° to +290°C)
EP	Annealed constantan foil with tough, high-elongation polyimide backing.	±10%	-100° to +400°F (-75° to +205°C)
SA	Fully encapsulated constantan gages with solder dots.	±2%	-100° to +400°F (-75° to +205°C)
SK	Fully encapsulated K-alloy gages with solder dots.	±1.5%	-452° to +450°F (-269° to +230°C)
SD	Equivalent to WD Series, but with solder dots instead of leadwires.	±1.5%	-320° to +400°F (-195° to +205°C)
WD	Fully encapsulated isoelastic gages with high-endurance leadwires.	±1.5%	-320° to +500°F (-195° to +260°C)



Note 1: Insert desired S-T-C number in spaces marked XX.

Note 2: Tolerance is increased when Option W, E, SE, LE, or P is specified.

Note 3: Products with designations and options shown in **bold** are not RoHS compliant.

*Options available but not normally recommended. See Optional Features data sheet for details.

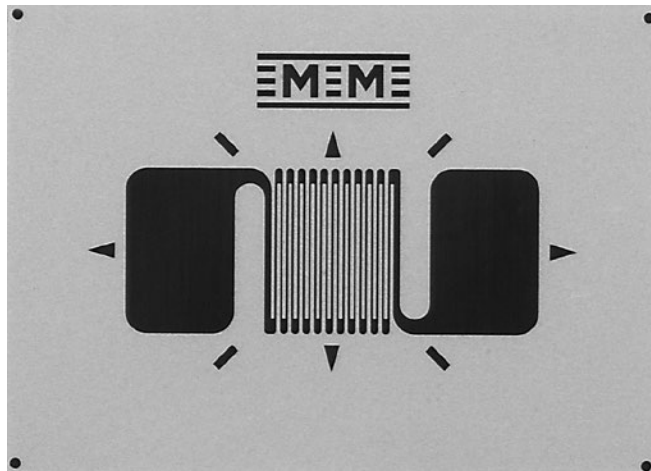
General Purpose Strain Gages—Linear Pattern

GAGE PATTERN DATA						
		GAGE DESIGNATION See Note 1, 3	RESISTANCE (OHMS) See Note 2	OPTIONS AVAILABLE See Note 3		
		EA-XX-062EN-350 ED-DY-062EN-500 WA-XX-062EN-350 WK-XX-062EN-500 EP-08-062EN-350 SA-XX-062EN-350 SK-XX-062EN-500 SD-DY-062EN-500 WD-DY-062EN-500	350 ± 0.15% 500 ± 0.4% 350 ± 0.3% 500 ± 0.3% 350 ± 0.15% 350 ± 0.3% 500 ± 0.3% 500 ± 0.8% 500 ± 0.8%	E, L, LE E, L*, LE*		
 actual size		DESCRIPTION Similar to 062ED pattern except for grid resistance.				
GAGE DIMENSIONS		Legend ES = Each Section S = Section (S1 = Section 1)			CP = Complete Pattern M = Matrix	<input type="checkbox"/> inch <input type="checkbox"/> millimeter
Gage Length	Overall Length	Grid Width	Overall Width	Matrix Length	Matrix Width	
0.062	0.076	0.062	0.190	0.23	0.31	
1.57	1.93	1.57	4.83	5.8	7.9	

GAGE SERIES DATA — See Gage Series datasheet for complete specifications			
Series	Description	Strain Range	Temperature Range
EA	Constantan foil in combination with a tough, flexible, polyimide backing.	±3%	-100° to +350°F (-75° to +175°C)
ED	Isoelastic foil in combination with tough, flexible polyimide film.	±2%	-320° to +400°F (-195° to +205°C)
WA	Fully encapsulated constantan gages with high-endurance leadwires.	±2%	-100° to +400°F (-75° to +205°C)
WK	Fully encapsulated K-alloy gages with high-endurance leadwires.	±1.5%	-452° to +550°F (-269° to +290°C)
EP	Annealed constantan foil with tough, high-elongation polyimide backing.	±10%	-100° to +400°F (-75° to +205°C)
SA	Fully encapsulated constantan gages with solder dots.	±2%	-100° to +400°F (-75° to +205°C)
SK	Fully encapsulated K-alloy gages with solder dots.	±1.5%	-452° to +450°F (-269° to +230°C)
SD	Equivalent to WD Series, but with solder dots instead of leadwires.	±1.5%	-320° to +400°F (-195° to +205°C)
WD	Fully encapsulated isoelastic gages with high-endurance leadwires.	±1.5%	-320° to +500°F (-195° to +260°C)



Note 1: Insert desired S-T-C number in spaces marked XX.

Note 2: Tolerance is increased when Option W, E, SE, LE, or P is specified.

Note 3: Products with designations and options shown in **bold** are not RoHS compliant.

*Options available but not normally recommended. See Optional Features data sheet for details.

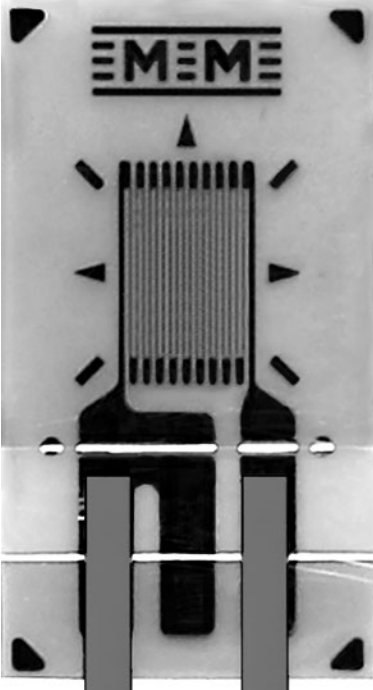
General Purpose Strain Gages – Linear Pattern

GAGE PATTERN DATA					
 <p style="text-align: center;">actual size</p>		GAGE DESIGNATION See Note 1	RESISTANCE (OHMS)	OPTIONS AVAILABLE	
		L2A-XX-062LW-120 L2A-XX-062LW-350 C2A-XX-062LW-120 C2A-XX-062LW-350	120 ± 0.6% 350 ± 0.6% 120 ± 0.6% 350 ± 0.6%		
DESCRIPTION Widely used general-purpose gage.					
GAGE DIMENSIONS		Legend ES = Each Section CP = Complete Pattern S = Section (S1 = Section 1) M = Matrix			<input type="checkbox"/> inch <input type="checkbox"/> millimeter
Gage Length	Overall Length	Grid Width	Overall Width	Matrix Length	Matrix Width
0.062	0.175	0.050	0.080	0.252	0.170
1.52	4.45	1.27	2.03	6.40	4.32

GAGE SERIES DATA — See Gage Series datasheet for complete specifications			
Series	Description	Strain Range	Temperature Range
L2A	Encapsulated constantan gages with preattached ribbon leads.	±3%	-100° to +250°F (-75° to +120°C)
C2A	Encapsulated constantan gages with preattached ready-to-use cables.	±3%	-60° to +180°F (-50° to +80°C)



Example of an
L2A Construction



Example of an
C2A Construction

Note 1: Insert desired S-T-C number in spaces marked XX.

General Purpose Strain Gages – Linear Pattern

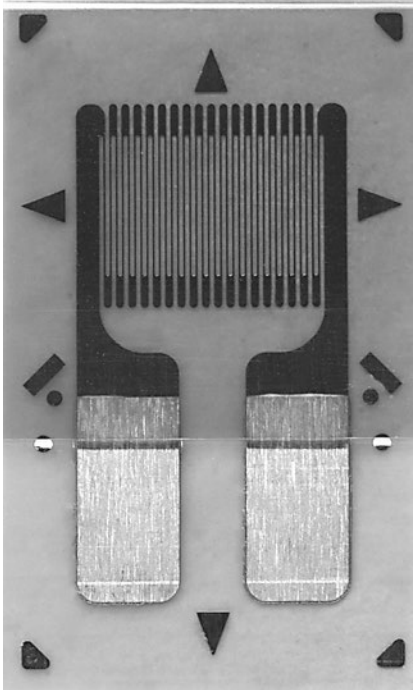
GAGE PATTERN DATA					
 <p>actual size</p>		GAGE DESIGNATION See Note 1	RESISTANCE (OHMS)	OPTIONS AVAILABLE See Note 2	
		CEA-XX-062UW-120 CEA-XX-062UW-350	120 ± 0.3% 350 ± 0.3%	P2 P2	
DESCRIPTION General-purpose gage. Exposed solder tab area is 0.07 x 0.04 in [1.8 x 1.0 mm].					
GAGE DIMENSIONS		Legend ES = Each Section CP = Complete Pattern S = Section (S1 = Section 1) M = Matrix			
				inch	
				millimeter	
Gage Length	Overall Length	Grid Width	Overall Width	Matrix Length	Matrix Width
0.062	0.220	0.120	0.120	0.31	0.19
1.57	5.59	3.05	3.05	7.9	4.8

GAGE SERIES DATA — See Gage Series datasheet for complete specifications			
Series	Description	Strain Range	Temperature Range
CEA	Universal general-purpose strain gages.	±3%	-100° to +350°F (-75° to +175°C)

Note 1: Insert desired S-T-C number in spaces marked XX.

Note 2: Products with designations and options shown in **bold** are not RoHS compliant.

General Purpose Strain Gages—Linear Pattern

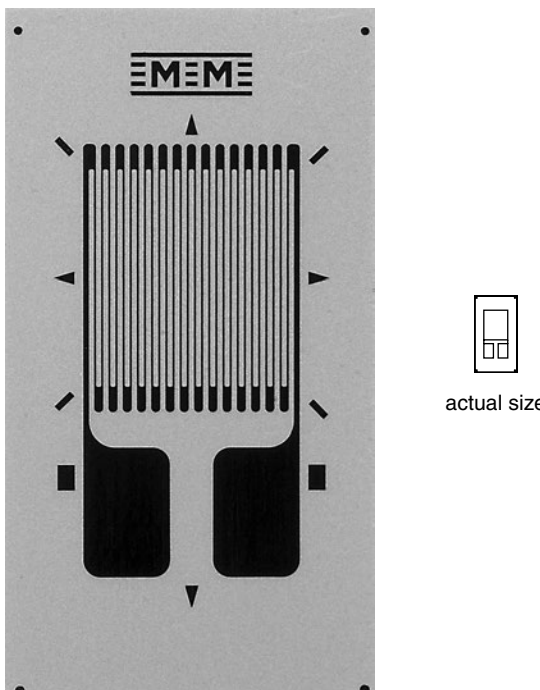
GAGE PATTERN DATA							
		GAGE DESIGNATION See Note 1, 3	RESISTANCE (OHMS) See Note 2	OPTIONS AVAILABLE See Note 3			
		EA-XX-125AC-350 ED-DY-125AC-10C EK-XX-125AC-10C S2K-XX-125AC-10C WA-XX-125AC-350 WK-XX-125AC-10C EP-08-125AC-350 SA-XX-125AC-350 SK-XX-125AC-10C SD-DY-125AC-10C WD-DY-125AC-10C	350 ± 0.15% 1000 ± 0.3% 1000 ± 0.15% 1000 ± 0.3% 350 ± 0.3% 1000 ± 0.3% 350 ± 0.15% 350 ± 0.3% 1000 ± 0.3% 1000 ± 0.6% 1000 ± 0.6%	W, E, L, LE, P E, L*, LE* W, SE W* W*			
DESCRIPTION Widely used general-purpose gage with high-resistance grid. See also 125AD, 125UN, and 125UW patterns. EK-Series gages are supplied with duplex copper pads (DP) when optional feature W or SE is not specified.							
GAGE DIMENSIONS		Legend ES = Each Section S = Section (S1 = Section 1)			<table border="1"> <tr><td>inch</td></tr> <tr><td>millimeter</td></tr> </table>	inch	millimeter
inch							
millimeter							
Gage Length	Overall Length	Grid Width	Overall Width	Matrix Length	Matrix Width		
0.125	0.250	0.125	0.125	0.40	0.22		
3.18	6.35	3.18	3.18	10.2	5.6		

GAGE SERIES DATA — See Gage Series datasheet for complete specifications			
Series	Description	Strain Range	Temperature Range
EA	Constantan foil in combination with a tough, flexible, polyimide backing.	±5%	-100° to +350°F (-75° to +175°C)
ED	Isoelastic foil in combination with tough, flexible polyimide film.	±2%	-320° to +400°F (-195° to +205°C)
EK	K-alloy foil in combination with a tough, flexible polyimide backing.	±1.5%	-320° to +350°F (-195° to +175°C)
S2K	K-alloy foil with laminated thick, high-performance polyimide backing.	±1.5%	-100° to +250°F (-75° to +120°C)
WA	Fully encapsulated constantan gages with high-endurance leadwires.	±2%	-100° to +400°F (-75° to +205°C)
WK	Fully encapsulated K-alloy gages with high-endurance leadwires.	±1.5%	-452° to +550°F (-269° to +290°C)
EP	Annealed constantan foil with tough, high-elongation polyimide backing.	±20%	-100° to +400°F (-75° to +205°C)
SA	Fully encapsulated constantan gages with solder dots.	±2%	-100° to +400°F (-75° to +205°C)
SK	Fully encapsulated K-alloy gages with solder dots.	±1.5%	-452° to +450°F (-269° to +230°C)
SD	Equivalent to WD Series, but with solder dots instead of leadwires.	±1.5%	-320° to +400°F (-195° to +205°C)
WD	Fully encapsulated isoelastic gages with high-endurance leadwires.	±1.5%	-320° to +500°F (-195° to +260°C)

Note 1: Insert desired S-T-C number in spaces marked XX.

Note 2: Tolerance is increased when Option W, E, SE, LE, or P is specified.

Note 3: Products with designations and options shown in **bold** are not RoHS compliant.

*Options available but not normally recommended. See Optional Features data sheet for details.

General Purpose Strain Gages – Linear Pattern

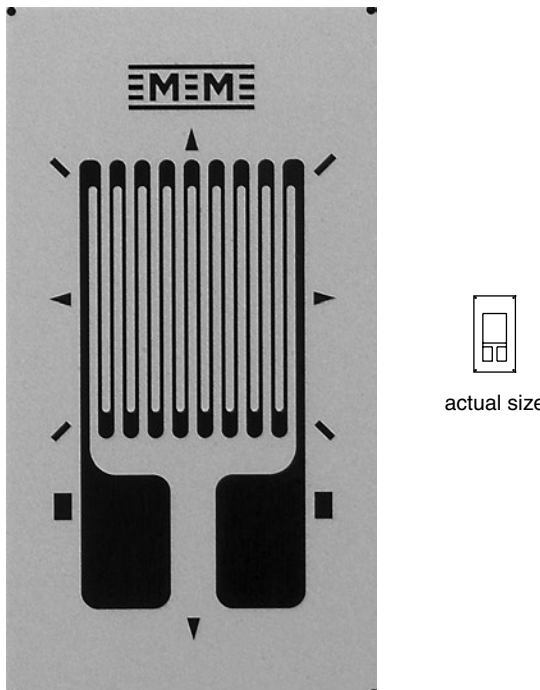
GAGE PATTERN DATA							
		GAGE DESIGNATION See Note 1, 3	RESISTANCE (OHMS) See Note 2	OPTIONS AVAILABLE See Note 3			
		EA-XX-125AD-120 ED-DY-125AD-350 EK-XX-125AD-350 WA-XX-125AD-120 WK-XX-125AD-350 EP-XX-125AD-120 SA-XX-125AD-120 SK-XX-125AD-350 SD-DY-125AD-350 WD-DY-125AD-350	120 ± 0.15% 350 ± 0.3% 350 ± 0.15% 120 ± 0.3% 350 ± 0.3% 120 ± 0.15% 120 ± 0.3% 350 ± 0.3% 350 ± 0.6% 350 ± 0.6%	W, E, L, LE, P E, L*, LE* W, SE W* W*			
DESCRIPTION Widely used general-purpose gage. EK-Series gages are supplied with duplex copper pads (DP) when optional feature W or SE is not specified.							
GAGE DIMENSIONS		Legend ES = Each Section CP = Complete Pattern S = Section (S1 = Section 1) M = Matrix					
				<table border="1"> <tr><td>inch</td></tr> <tr><td>millimeter</td></tr> </table>	inch	millimeter	
inch							
millimeter							
Gage Length	Overall Length	Grid Width	Overall Width	Matrix Length	Matrix Width		
0.125	0.250	0.125	0.125	0.40	0.22		
3.18	6.35	3.18	3.18	10.2	5.6		

GAGE SERIES DATA — See Gage Series datasheet for complete specifications			
Series	Description	Strain Range	Temperature Range
EA	Constantan foil in combination with a tough, flexible, polyimide backing.	±5%	-100° to +350°F (-75° to +175°C)
ED	Isoelastic foil in combination with tough, flexible polyimide film.	±2%	-320° to +400°F (-195° to +205°C)
EK	K-alloy foil in combination with a tough, flexible polyimide backing.	±1.5%	-320° to +350°F (-195° to +175°C)
WA	Fully encapsulated constantan gages with high-endurance leadwires.	±2%	-100° to +400°F (-75° to +205°C)
WK	Fully encapsulated K-alloy gages with high-endurance leadwires.	±1.5%	-452° to +550°F (-269° to +290°C)
EP	Annealed constantan foil with tough, high-elongation polyimide backing.	±20%	-100° to +400°F (-75° to +205°C)
SA	Fully encapsulated constantan gages with solder dots.	±2%	-100° to +400°F (-75° to +205°C)
SK	Fully encapsulated K-alloy gages with solder dots.	±1.5%	-452° to +450°F (-269° to +230°C)
SD	Equivalent to WD Series, but with solder dots instead of leadwires.	±1.5%	-320° to +400°F (-195° to +205°C)
WD	Fully encapsulated isoelastic gages with high-endurance leadwires.	±1.5%	-320° to +500°F (-195° to +260°C)

Note 1: Insert desired S-T-C number in spaces marked XX.

Note 2: Tolerance is increased when Option W, E, SE, LE, or P is specified.

Note 3: Products with designations and options shown in **bold** are not RoHS compliant.

*Options available but not normally recommended. See Optional Features data sheet for details.

General Purpose Strain Gages – Linear Pattern

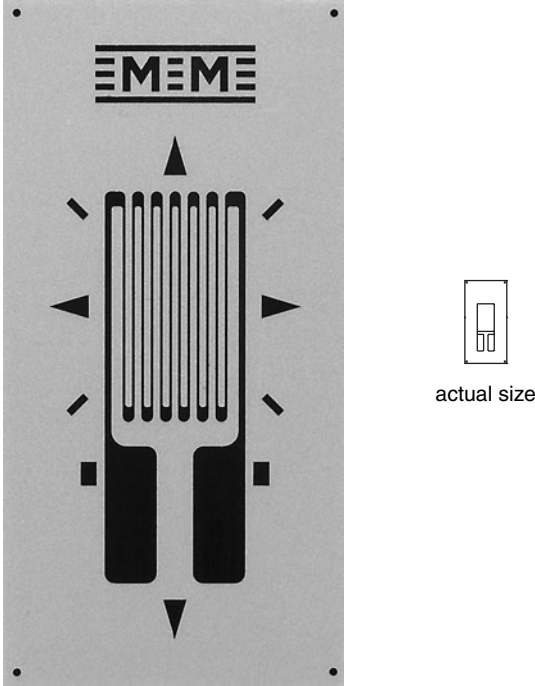
GAGE PATTERN DATA					
		GAGE DESIGNATION See Note 1, 3	RESISTANCE (OHMS) See Note 2	OPTIONS AVAILABLE See Note 3	
		EA-XX-125BB-120 ED-DY-125BB-350 WA-XX-125BB-120 WK-XX-125BB-350 EP-08-125BB-120 SA-XX-125BB-120 SK-XX-125BB-350 SD-DY-125BB-350 WD-DY-125BB-350	120 ± 0.15% 350 ± 0.3% 120 ± 0.3% 350 ± 0.3% 120 ± 0.15% 120 ± 0.3% 350 ± 0.3% 350 ± 0.6% 350 ± 0.6%	E, P E	
DESCRIPTION Narrow general-purpose gage with extended tabs.					
GAGE DIMENSIONS		Legend ES = Each Section CP = Complete Pattern S = Section (S1 = Section 1) M = Matrix			
				inch	
				millimeter	
Gage Length	Overall Length	Grid Width	Overall Width	Matrix Length	Matrix Width
0.125	0.245	0.088	0.088	0.43	0.22
3.18	6.22	2.24	2.24	10.9	5.6

GAGE SERIES DATA — See Gage Series datasheet for complete specifications			
Series	Description	Strain Range	Temperature Range
EA	Constantan foil in combination with a tough, flexible, polyimide backing.	±5%	-100° to +350°F (-75° to +175°C)
ED	Isoelastic foil in combination with tough, flexible polyimide film.	±2%	-320° to +400°F (-195° to +205°C)
WA	Fully encapsulated constantan gages with high-endurance leadwires.	±2%	-100° to +400°F (-75° to +205°C)
WK	Fully encapsulated K-alloy gages with high-endurance leadwires.	±1.5%	-452° to +550°F (-269° to +290°C)
EP	Annealed constantan foil with tough, high-elongation polyimide backing.	±20%	-100° to +400°F (-75° to +205°C)
SA	Fully encapsulated constantan gages with solder dots.	±2%	-100° to +400°F (-75° to +205°C)
SK	Fully encapsulated K-alloy gages with solder dots.	±1.5%	-452° to +450°F (-269° to +230°C)
SD	Equivalent to WD Series, but with solder dots instead of leadwires.	±1.5%	-320° to +400°F (-195° to +205°C)
WD	Fully encapsulated isoelastic gages with high-endurance leadwires.	±1.5%	-320° to +500°F (-195° to +260°C)

Note 1: Insert desired S-T-C number in spaces marked XX.

Note 2: Tolerance is increased when Option W, E, SE, LE, or P is specified.

Note 3: Products with designations and options shown in **bold** are not RoHS compliant.

General Purpose Strain Gages – Linear Pattern

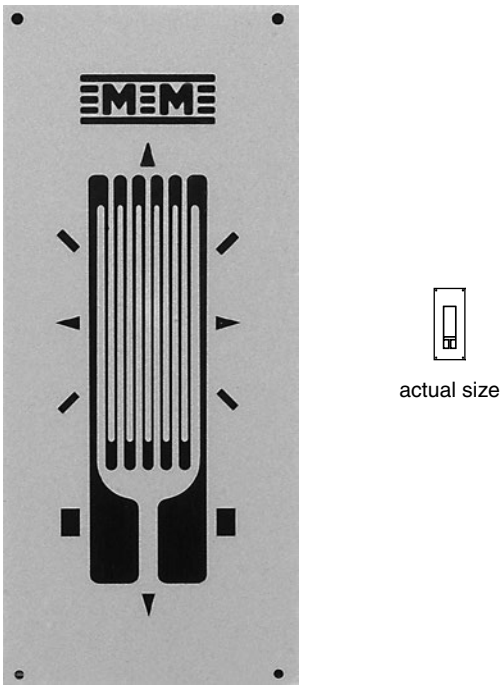
GAGE PATTERN DATA							
		GAGE DESIGNATION See Note 1, 3	RESISTANCE (OHMS) See Note 2	OPTIONS AVAILABLE See Note 3			
		EA-XX-125BT-120 ED-DY-125BT-350 WA-XX-125BT-120 WK-XX-125BT-350 EP-08-125BT-120 SA-XX-125BT-120 SK-XX-125BT-350 SD-DY-125BT-350 WD-DY-125BT-350	120 ± 0.15% 350 ± 0.3% 120 ± 0.3% 350 ± 0.3% 120 ± 0.15% 120 ± 0.3% 350 ± 0.3% 350 ± 0.6% 350 ± 0.6%	W, E, L, LE, P E, L*, LE* W* W*			
DESCRIPTION General-purpose gage with narrow grid and compact geometry. See also 125BZ pattern.							
GAGE DIMENSIONS		Legend ES = Each Section CP = Complete Pattern S = Section (S1 = Section 1) M = Matrix					
				<table border="1"> <tr><td>inch</td></tr> <tr><td>millimeter</td></tr> </table>		inch	millimeter
inch							
millimeter							
Gage Length	Overall Length	Grid Width	Overall Width	Matrix Length	Matrix Width		
0.125	0.215	0.062	0.062	0.37	0.16		
3.18	5.46	1.57	1.57	9.4	4.1		

GAGE SERIES DATA — See Gage Series datasheet for complete specifications			
Series	Description	Strain Range	Temperature Range
EA	Constantan foil in combination with a tough, flexible, polyimide backing.	±5%	-100° to +350°F (-75° to +175°C)
ED	Isoelastic foil in combination with tough, flexible polyimide film.	±2%	-320° to +400°F (-195° to +205°C)
WA	Fully encapsulated constantan gages with high-endurance leadwires.	±2%	-100° to +400°F (-75° to +205°C)
WK	Fully encapsulated K-alloy gages with high-endurance leadwires.	±1.5%	-452° to +550°F (-269° to +290°C)
EP	Annealed constantan foil with tough, high-elongation polyimide backing.	±20%	-100° to +400°F (-75° to +205°C)
SA	Fully encapsulated constantan gages with solder dots.	±2%	-100° to +400°F (-75° to +205°C)
SK	Fully encapsulated K-alloy gages with solder dots.	±1.5%	-452° to +450°F (-269° to +230°C)
SD	Equivalent to WD Series, but with solder dots instead of leadwires.	±1.5%	-320° to +400°F (-195° to +205°C)
WD	Fully encapsulated isoelastic gages with high-endurance leadwires.	±1.5%	-320° to +500°F (-195° to +260°C)

Note 1: Insert desired S-T-C number in spaces marked XX.

Note 2: Tolerance is increased when Option W, E, SE, LE, or P is specified.

Note 3: Products with designations and options shown in **bold** are not RoHS compliant.

*Options available but not normally recommended. See Optional Features data sheet for details.

General Purpose Strain Gages – Linear Pattern

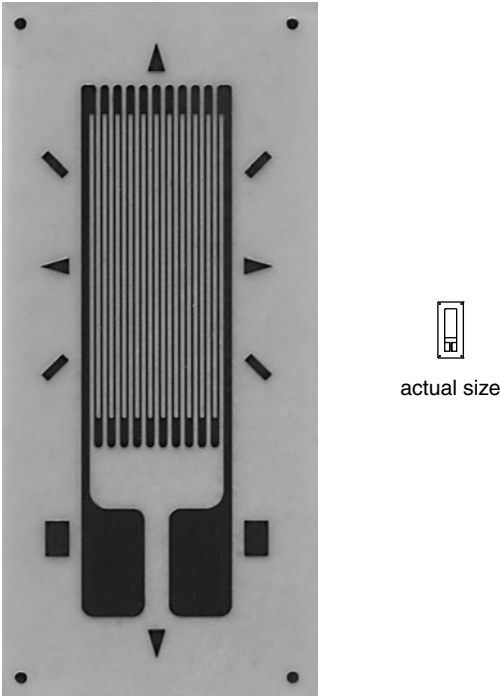
GAGE PATTERN DATA							
 <p>actual size</p>		GAGE DESIGNATION See Note 1, 3	RESISTANCE (OHMS) See Note 2	OPTIONS AVAILABLE See Note 3			
		EA-XX-125BZ-350 ED-DY-125BZ-10C EK-XX-125BZ-10C WA-XX-125BZ-350 WK-XX-125BZ-10C SA-XX-125BZ-350 SK-XX-125BZ-10C SD-DY-125BZ-10C WD-DY-125BZ-10C	350 ± 0.15% 1000 ± 0.4% 1000 ± 0.15% 350 ± 0.3% 1000 ± 0.3% 350 ± 0.3% 1000 ± 0.3% 1000 ± 0.8% 1000 ± 0.8%	W, E, L, LE, P E, L*, LE* W* W*			
DESCRIPTION Narrow high-resistance gage with compact geometry. Similar to 125BT pattern except for grid resistance. EK-Series gages are supplied with duplex copper dots(DD) when optional feature W is not specified.							
GAGE DIMENSIONS		Legend ES = Each Section S = Section (S1 = Section 1)			<table border="1"> <tr><td>inch</td></tr> <tr><td>millimeter</td></tr> </table>	inch	millimeter
inch							
millimeter							
Gage Length	Overall Length	Grid Width	Overall Width	Matrix Length	Matrix Width		
0.125	0.220	0.062	0.062	0.29	0.13		
3.18	5.59	1.57	1.57	7.4	3.3		

GAGE SERIES DATA — See Gage Series datasheet for complete specifications			
Series	Description	Strain Range	Temperature Range
EA	Constantan foil in combination with a tough, flexible, polyimide backing.	±5%	-100° to +350°F (-75° to +175°C)
ED	Isoelastic foil in combination with tough, flexible polyimide film.	±2%	-320° to +400°F (-195° to +205°C)
EK	K-alloy foil in combination with a tough, flexible polyimide backing.	±1.5%	-320° to +350°F (-195° to +175°C)
WA	Fully encapsulated constantan gages with high-endurance leadwires.	±2%	-100° to +400°F (-75° to +205°C)
WK	Fully encapsulated K-alloy gages with high-endurance leadwires.	±1.5%	-452° to +550°F (-269° to +290°C)
SA	Fully encapsulated constantan gages with solder dots.	±2%	-100° to +400°F (-75° to +205°C)
SK	Fully encapsulated K-alloy gages with solder dots.	±1.5%	-452° to +450°F (-269° to +230°C)
SD	Equivalent to WD Series, but with solder dots instead of leadwires.	±1.5%	-320° to +400°F (-195° to +205°C)
WD	Fully encapsulated isoelastic gages with high-endurance leadwires.	±1.5%	-320° to +500°F (-195° to +260°C)



Note 1: Insert desired S-T-C number in spaces marked XX.

Note 2: Tolerance is increased when Option W, E, SE, LE, or P is specified.

Note 3: Products with designations and options shown in **bold** are not RoHS compliant.

*Options available but not normally recommended. See Optional Features data sheet for details.

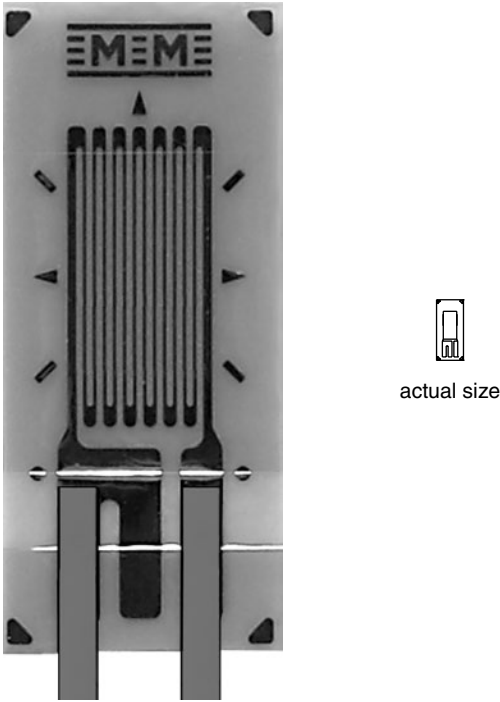
General Purpose Strain Gages – Linear Pattern

GAGE PATTERN DATA					
		GAGE DESIGNATION See Note 1	RESISTANCE (OHMS)	OPTIONS AVAILABLE	
		L2A-XX-125LW-120 L2A-XX-125LW-350 C2A-XX-125LW-120 C2A-XX-125LW-350	120 ± 0.6% 350 ± 0.6% 120 ± 0.6% 350 ± 0.6%		
DESCRIPTION Widely used general-purpose gage.					
GAGE DIMENSIONS		Legend ES = Each Section CP = Complete Pattern S = Section (S1 = Section 1) M = Matrix			<input type="checkbox"/> inch <input type="checkbox"/> millimeter
Gage Length	Overall Length	Grid Width	Overall Width	Matrix Length	Matrix Width
0.125	0.238	0.070	0.080	0.315	0.170
3.18	6.05	1.78	2.03	8.00	4.32

GAGE SERIES DATA — See Gage Series datasheet for complete specifications			
Series	Description	Strain Range	Temperature Range
L2A	Encapsulated constantan gages with preattached ribbon leads.	±3%	-100° to +250°F (-75° to +120°C)
C2A	Encapsulated constantan gages with preattached ready-to-use cables.	±3%	-60° to +180°F (-50° to +80°C)



Example of an
L2A Construction



Example of an
C2A Construction

Note 1: Insert desired S-T-C number in spaces marked XX.

General Purpose Strain Gages – Linear Pattern

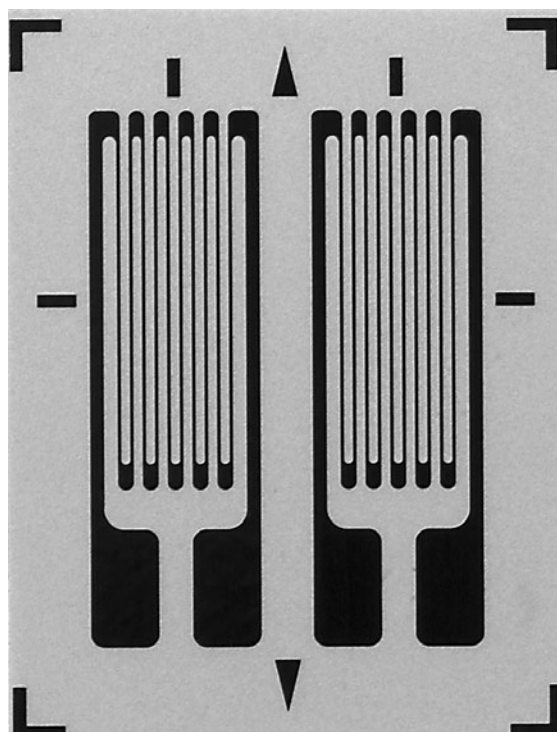
GAGE PATTERN DATA							
			GAGE DESIGNATION See Note 1, 3	RESISTANCE (OHMS) See Note 2	OPTIONS AVAILABLE See Note 3		
			EA-XX-125PC-120 EA-XX-125PC-350 ED-DY-125PC-350 ED-DY-125PC-10C EK-XX-125PC-10C WA-XX-125PC-120 WA-XX-125PC-350 WK-XX-125PC-350 WK-XX-125PC-10C SA-XX-125PC-120 SA-XX-125PC-350 SK-XX-125PC-350 SK-XX-125PC-10C	120 ± 0.2% 350 ± 0.2% 350 ± 0.4% 1000 ± 0.4% 1000 ± 0.2% 120 ± 0.4% 350 ± 0.4% 350 ± 0.4% 1000 ± 0.4% 1000 ± 0.4% 120 ± 0.4% 350 ± 0.4% 350 ± 0.4% 1000 ± 0.4%	W, E, L, LE W, E, L, LE E E W, SE W* W* W* W*		
DESCRIPTION Dual-pattern gage for use in back-to-back bending applications. Longitudinal grid centerlines spaced 0.085 in [2.16 mm] apart. See also 125MG pattern. EK-Series gages are supplied with duplex copper pads (DP) when optional W or SE is not specified.							
GAGE DIMENSIONS		Legend ES = Each Section CP = Complete Pattern S = Section (S1 = Section 1) M = Matrix					
					<table border="1"> <tr><td>inch</td></tr> <tr><td>millimeter</td></tr> </table>	inch	millimeter
inch							
millimeter							
Gage Length	Overall Length	Grid Width	Overall Width	Matrix Length	Matrix Width		
0.125 ES	0.205 CP	0.065 ES	0.150 CP	0.29	0.23		
3.18 ES	5.21 CP	1.65 ES	3.81 CP	7.4	5.8		

GAGE SERIES DATA — See Gage Series datasheet for complete specifications			
Series	Description	Strain Range	Temperature Range
EA	Constantan foil in combination with a tough, flexible, polyimide backing.	±5%	-100° to +350°F (-75° to +175°C)
ED	Isoelastic foil in combination with tough, flexible polyimide film.	±2%	-320° to +400°F (-195° to +205°C)
EK	K-alloy foil in combination with a tough, flexible polyimide backing.	±1.5%	-320° to +350°F (-195° to +175°C)
WA	Fully encapsulated constantan gages with high-endurance leadwires.	±2%	-100° to +400°F (-75° to +205°)
WK	Fully encapsulated K-alloy gages with high-endurance leadwires.	±1.5%	-452° to +550°F (-269° to +290°C)
SA	Fully encapsulated constantan gages with solder dots.	±2%	-100° to +400°F (-75° to +205°C)
SK	Fully encapsulated K-alloy gages with solder dots.	±1.5%	-452° to +450°F (-269° to +230°C)

Note 1: Insert desired S-T-C number in spaces marked XX.

Note 2: Tolerance is increased when Option W, E, SE, LE, or P is specified.

Note 3: Products with designations and options shown in **bold** are not RoHS compliant.

*Options available but not normally recommended. See Optional Features datasheet for details.

General Purpose Strain Gages – Linear Pattern

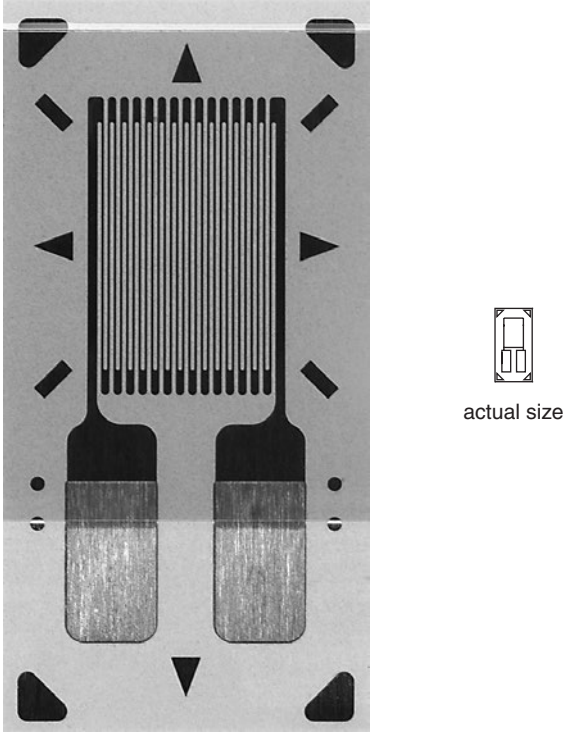
GAGE PATTERN DATA					
		GAGE DESIGNATION See Note 1	RESISTANCE (OHMS)	OPTIONS AVAILABLE See Note 2	
		CEA-XX-125UN-120 CEA-XX-125UN-350	120 ± 0.3% 350 ± 0.3%	P2 P2	
DESCRIPTION General-purpose gage with narrow geometry. Exposed solder tab area 0.06 x 0.05 in (1.5 x 1.1 mm). See also 125UW pattern.					
GAGE DIMENSIONS		Legend			
		ES = Each Section S = Section (S1 = Section 1)		CP = Complete Pattern M = Matrix	
				inch	millimeter
Gage Length	Overall Length	Grid Width	Overall Width	Matrix Length	Matrix Width
0.125	0.275	0.100	0.120	0.38	0.19
3.18	6.99	2.54	3.05	9.7	4.8

GAGE SERIES DATA — See Gage Series datasheet for complete specifications			
Series	Description	Strain Range	Temperature Range
CEA	Universal general-purpose strain gages.	±5%	-100° to +350°F (-75° to +175°C)

Note 1: Insert desired S-T-C number in spaces marked XX.

Note 2: Products with designations and options shown in bold are not RoHS compliant.

General Purpose Strain Gages—Linear Pattern

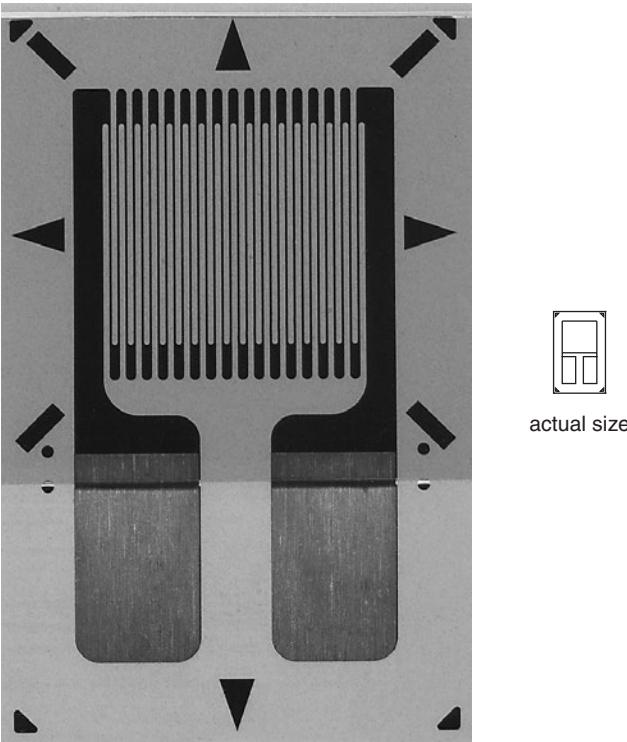
GAGE PATTERN DATA					
			GAGE DESIGNATION See Note 1	RESISTANCE (OHMS)	OPTIONS AVAILABLE See Note 2
			CEA-XX-125UW-120 CEA-XX-125UW-350	120 ± 0.3% 350 ± 0.3%	P2 P2
<p>DESCRIPTION</p> <p>General-purpose gage. Exposed solder tab area 0.10 x 0.07 (2.5 x 1.8 mm). See also 125UN pattern.</p>					
GAGE DIMENSIONS			<p>Legend</p> <p>ES = Each Section CP = Complete Pattern <input type="checkbox"/> inch</p> <p>S = Section (S1 = Section 1) M = Matrix <input type="checkbox"/> millimeter</p>		
Gage Length	Overall Length	Grid Width	Overall Width	Matrix Length	Matrix Width
0.125	0.325	0.180	0.180	0.42	0.27
3.18	8.26	4.57	4.57	10.7	6.9

GAGE SERIES DATA — See Gage Series datasheet for complete specifications			
Series	Description	Strain Range	Temperature Range
CEA	Universal general-purpose strain gages.	±5%	-100° to +350°F (-75° to +175°C)

Note 1: Insert desired S-T-C number in spaces marked XX.

Note 2: Products with designations and options shown in bold are not RoHS compliant.

General Purpose Strain Gages—Linear Pattern

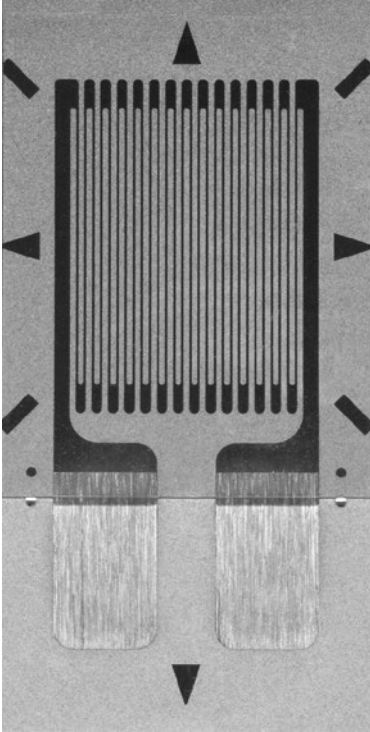
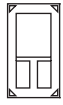
GAGE PATTERN DATA							
  actual size	GAGE DESIGNATION See Note 1	RESISTANCE (OHMS)	OPTIONS AVAILABLE See Note 2				
	CEA-XX-187UW-120 CEA-XX-187UW-350	120 ± 0.3% 350 ± 0.3%	P2 P2				
	DESCRIPTION General-purpose gage. Exposed solder tab area 0.10 x 0.07 in (2.5 x 1.8 mm).						
GAGE DIMENSIONS		Legend ES = Each Section CP = Complete Pattern S = Section (S1 = Section 1) M = Matrix					
				<table border="1"> <tr><td>inch</td></tr> <tr><td>millimeter</td></tr> </table>	inch	millimeter	
inch							
millimeter							
Gage Length	Overall Length	Grid Width	Overall Width	Matrix Length	Matrix Width		
0.187	0.387	0.180	0.180	0.49	0.27		
4.75	9.83	4.57	4.57	12.4	6.9		

GAGE SERIES DATA — See Gage Series datasheet for complete specifications			
Series	Description	Strain Range	Temperature Range
CEA	Universal general-purpose strain gages.	±5%	-100° to +350°F (-75° to +175°C)

Note 1: Insert desired S-T-C number in spaces marked XX.

Note 2: Products with designations and options shown in **bold** are not RoHS compliant.

General Purpose Strain Gages – Linear Pattern

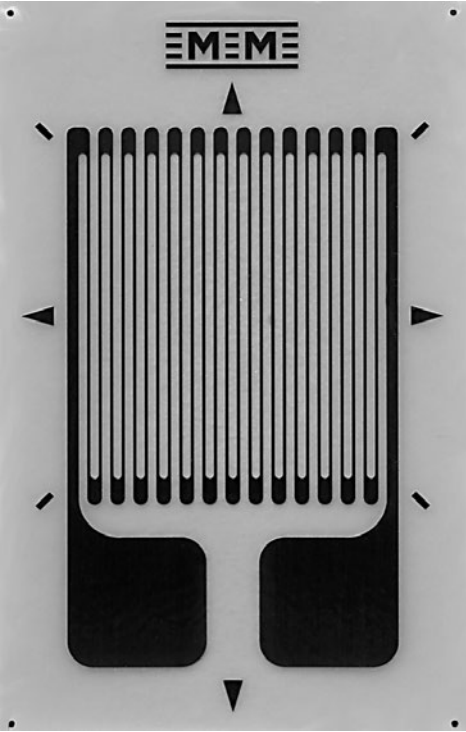
GAGE PATTERN DATA								
		GAGE DESIGNATION See Note 1, 3	RESISTANCE (OHMS) See Note 2	OPTIONS AVAILABLE See Note 3				
		EA-XX-250AE-350 ED-DY-250AE-10C WA-XX-250AE-350 WK-XX-250AE-10C EP-08-250AE-350 SA-XX-250AE-350 SK-XX-250AE-10C SD-DY-250AE-10C WD-DY-250AE-10C	350 ± 0.15% 1000 ± 0.3% 350 ± 0.3% 1000 ± 0.3% 350 ± 0.15% 350 ± 0.3% 1000 ± 0.3% 1000 ± 0.6% 1000 ± 0.6%	W, E, L, LE, P E, L*, LE* W* W*				
DESCRIPTION General-purpose gage with high-dissipation grid. See also 250AF pattern.								
GAGE DIMENSIONS		Legend ES = Each Section S = Section (S1 = Section 1)			CP = Complete Pattern M = Matrix	<table border="1"> <tr><td>inch</td></tr> <tr><td>millimeter</td></tr> </table>	inch	millimeter
inch								
millimeter								
Gage Length	Overall Length	Grid Width	Overall Width	Matrix Length	Matrix Width			
0.250	0.415	0.250	0.250	0.57	0.36			
6.35	10.54	6.35	6.35	14.5	9.1			

GAGE SERIES DATA — See Gage Series datasheet for complete specifications			
Series	Description	Strain Range	Temperature Range
EA	Constantan foil in combination with a tough, flexible, polyimide backing.	±5%	-100° to +350°F (-75° to +175°C)
ED	Isoelastic foil in combination with tough, flexible polyimide film.	±2%	-320° to +400°F (-195° to +205°C)
WA	Fully encapsulated constantan gages with high-endurance leadwires.	±2%	-100° to +400°F (-75° to +205°)
WK	Fully encapsulated K-alloy gages with high-endurance leadwires.	±1.5%	-452° to +550°F (-269° to +290°C)
EP	Annealed constantan foil with tough, high-elongation polyimide backing.	±20%	-100° to +400°F (-75° to +205°C)
SA	Fully encapsulated constantan gages with solder dots.	±2%	-100° to +400°F (-75° to +205°C)
SK	Fully encapsulated K-alloy gages with solder dots.	±1.5%	-452° to +450°F (-269° to +230°C)
SD	Equivalent to WD Series, but with solder dots instead of leadwires.	±1.5%	-320° to +400°F (-195° to +205°C)
WD	Fully encapsulated isoelastic gages with high-endurance leadwires.	±1.5%	-320° to +500°F (-195° to +260°C)

Note 1: Insert desired S-T-C number in spaces marked XX.

Note 2: Tolerance is increased when Option W, E, SE, LE, or P is specified.

Note 3: Products with designations and options shown in **bold** are not RoHS compliant.

*Options available but not normally recommended. See Optional Features datasheet for details.

General Purpose Strain Gages—Linear Pattern

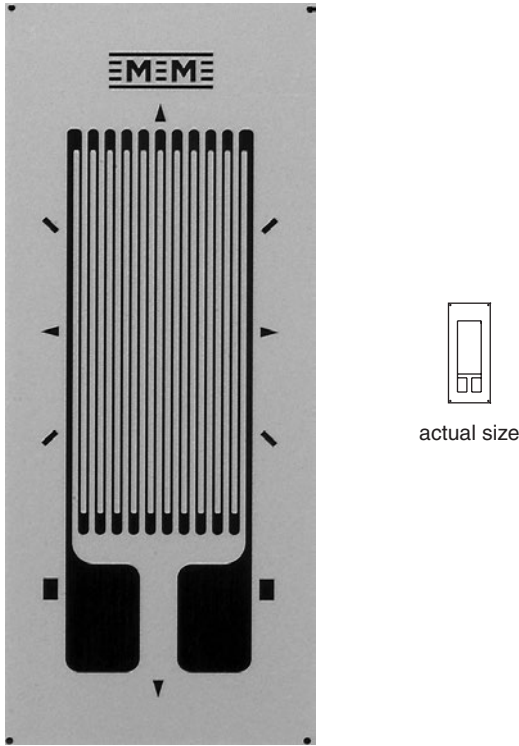
GAGE PATTERN DATA								
		GAGE DESIGNATION See Note 1, 3	RESISTANCE (OHMS) See Note 2	OPTIONS AVAILABLE See Note 3				
		EA-XX-250BF-350 ED-DY-250BF-10C EK-XX-250BF-10C S2K-XX-250BF-10C WA-XX-250BF-350 WK-XX-250BF-10C EP-08-250BF-350 SA-XX-250BF-350 SK-XX-250BF-10C SD-DY-250BF-10C WD-DY-250BF-10C	350 ± 0.15% 1000 ± 0.3% 1000 ± 0.15% 1000 ± 0.3% 350 ± 0.3% 1000 ± 0.3% 350 ± 0.15% 350 ± 0.3% 1000 ± 0.3% 1000 ± 0.6% 1000 ± 0.6%	W, E, L, LE, P E, L*, LE* W, SE W*				
DESCRIPTION General-purpose gage with high-resistance grid. Compact geometry. Similar to 250BG pattern except for resistance. See also 250BM and 250UW patterns. EK-Series gages are supplied with duplex copper pads (DP) when optional feature W or SE is not specified.								
GAGE DIMENSIONS		Legend ES = Each Section S = Section (S1 = Section 1)			CP = Complete Pattern M = Matrix	<table border="1"> <tr> <td>inch</td> </tr> <tr> <td>millimeter</td> </tr> </table>	inch	millimeter
inch								
millimeter								
Gage Length	Overall Length	Grid Width	Overall Width	Matrix Length	Matrix Width			
0.250	0.375	0.125	0.125	0.52	0.22			
6.35	9.53	3.18	3.18	13.2	5.6			

GAGE SERIES DATA — See Gage Series datasheet for complete specifications			
Series	Description	Strain Range	Temperature Range
EA	Constantan foil in combination with a tough, flexible, polyimide backing.	±5%	-100° to +350°F (-75° to +175°C)
ED	Isoelastic foil in combination with tough, flexible polyimide film.	±2%	-320° to +400°F (-195° to +205°C)
EK	K-alloy foil in combination with a tough, flexible polyimide backing.	±1.5%	-320° to +350°F (-195° to +175°C)
S2K	K-alloy foil with laminated thick, high-performance polyimide backing.	±1.5%	-100° to +250°F (-75° to +120°C)
WA	Fully encapsulated constantan gages with high-endurance leadwires.	±2%	-100° to +400°F (-75° to +205°)
WK	Fully encapsulated K-alloy gages with high-endurance leadwires.	±1.5%	-452° to +550°F (-269° to +290°C)
EP	Annealed constantan foil with tough, high-elongation polyimide backing.	±20%	-100° to +400°F (-75° to +205°C)
SA	Fully encapsulated constantan gages with solder dots.	±2%	-100° to +400°F (-75° to +205°C)
SK	Fully encapsulated K-alloy gages with solder dots.	±1.5%	-452° to +450°F (-269° to +230°C)
SD	Equivalent to WD Series, but with solder dots instead of leadwires.	±1.5%	-320° to +400°F (-195° to +205°C)
WD	Fully encapsulated isoelastic gages with high-endurance leadwires.	±1.5%	-320° to +500°F (-195° to +260°C)

Note 1: Insert desired S-T-C number in spaces marked XX.

Note 2: Tolerance is increased when Option W, E, SE, LE, or P is specified.

Note 3: Products with designations and options shown in **bold** are not RoHS compliant.

*Options available but not normally recommended. See Optional Features datasheet for details.

General Purpose Strain Gages—Linear Pattern

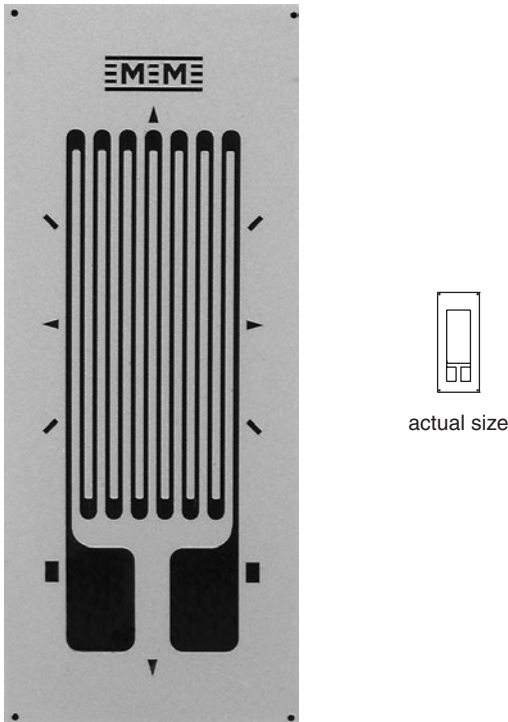
GAGE PATTERN DATA					
			GAGE DESIGNATION See Note 1, 3	RESISTANCE (OHMS) See Note 2	OPTIONS AVAILABLE See Note 3
			EA-XX-250BG-120 ED-DY-250BG-350 WA-XX-250BG-120 WK-XX-250BG-350 EP-XX-250BG-120 SA-XX-250BG-120 SK-XX-250BG-350 SD-DY-250BG-350 WD-DY-250BG-350	120 ± 0.15% 350 ± 0.3% 120 ± 0.3% 350 ± 0.3% 120 ± 0.15% 120 ± 0.3% 350 ± 0.3% 350 ± 0.6% 350 ± 0.6%	W, E, L, LE, P E, L*, LE* W* W*
DESCRIPTION Widely used general-purpose gage. Compact geometry. See also 250UN pattern.					
GAGE DIMENSIONS		Legend ES = Each Section CP = Complete Pattern S = Section (S1 = Section 1) M = Matrix			
					<input type="checkbox"/> inch <input type="checkbox"/> millimeter
Gage Length	Overall Length	Grid Width	Overall Width	Matrix Length	Matrix Width
0.250	0.375	0.125	0.125	0.52	0.22
6.35	9.53	3.18	3.18	13.2	5.6

GAGE SERIES DATA — See Gage Series datasheet for complete specifications			
Series	Description	Strain Range	Temperature Range
EA	Constantan foil in combination with a tough, flexible, polyimide backing.	±5%	-100° to +350°F (-75° to +175°C)
ED	Isoelastic foil in combination with tough, flexible polyimide film.	±2%	-320° to +400°F (-195° to +205°C)
WA	Fully encapsulated constantan gages with high-endurance leadwires.	±2%	-100° to +400°F (-75° to +205°)
WK	Fully encapsulated K-alloy gages with high-endurance leadwires.	±1.5%	-452° to +550°F (-269° to +290°C)
EP	Annealed constantan foil with tough, high-elongation polyimide backing.	±20%	-100° to +400°F (-75° to +205°C)
SA	Fully encapsulated constantan gages with solder dots.	±2%	-100° to +400°F (-75° to +205°C)
SK	Fully encapsulated K-alloy gages with solder dots.	±1.5%	-452° to +450°F (-269° to +230°C)
SD	Equivalent to WD Series, but with solder dots instead of leadwires.	±1.5%	-320° to +400°F (-195° to +205°C)
WD	Fully encapsulated isoelastic gages with high-endurance leadwires.	±1.5%	-320° to +500°F (-195° to +260°C)

Note 1: Insert desired S-T-C number in spaces marked XX.

Note 2: Tolerance is increased when Option W, E, SE, LE, or P is specified.

Note 3: Products with designations and options shown in **bold** are not RoHS compliant.

*Options available but not normally recommended. See Optional Features datasheet for details.

General Purpose Strain Gages – Linear Pattern

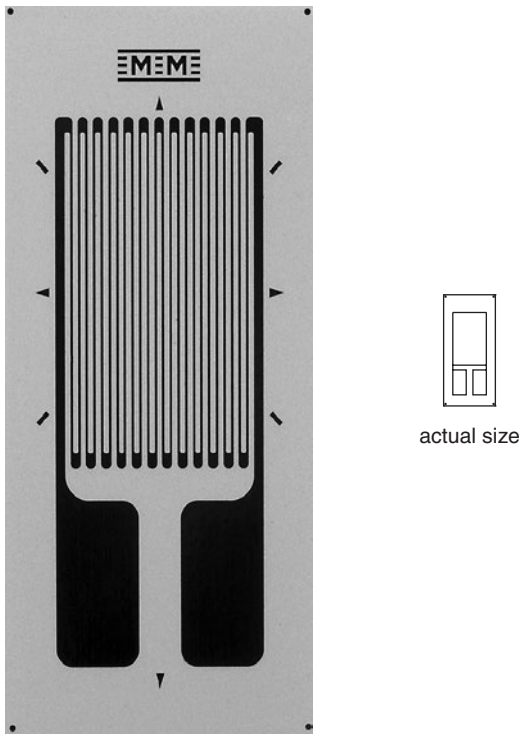
GAGE PATTERN DATA							
			GAGE DESIGNATION See Note 1, 3	RESISTANCE (OHMS) See Note 2	OPTIONS AVAILABLE See Note 3		
			EA-XX-250BK-10C WA-XX-250BK-10C WK-XX-250BK-30C SA-XX-250BK-10C SK-XX-250BK-30C	1000 ± 0.15% 1000 ± 0.3% 3000 ± 0.3% 1000 ± 0.3% 3000 ± 0.3%	W, E, L, LE, P W* W*		
DESCRIPTION High-resistance gage with good power dissipation capability for high-output applications or use on plastics.							
GAGE DIMENSIONS		Legend ES = Each Section CP = Complete Pattern S = Section (S1 = Section 1) M = Matrix					
				<table border="1"> <tr><td>inch</td></tr> <tr><td>millimeter</td></tr> </table>		inch	millimeter
inch							
millimeter							
Gage Length	Overall Length	Grid Width	Overall Width	Matrix Length	Matrix Width		
0.250	0.430	0.175	0.175	0.58	0.27		
6.35	10.92	4.45	4.45	14.7	6.9		

GAGE SERIES DATA — See Gage Series datasheet for complete specifications			
Series	Description	Strain Range	Temperature Range
EA	Constantan foil in combination with a tough, flexible, polyimide backing.	±5%	-100° to +350°F (-75° to +175°C)
WA	Fully encapsulated constantan gages with high-endurance leadwires.	±2%	-100° to +400°F (-75° to +205°)
WK	Fully encapsulated K-alloy gages with high-endurance leadwires.	±1.5%	-452° to +550°F (-269° to +290°C)
SA	Fully encapsulated constantan gages with solder dots.	±2%	-100° to +400°F (-75° to +205°C)
SK	Fully encapsulated K-alloy gages with solder dots.	±1.5%	-452° to +450°F (-269° to +230°C)



Note 1: Insert desired S-T-C number in spaces marked XX.

Note 2: Tolerance is increased when Option W, E, SE, LE, or P is specified.

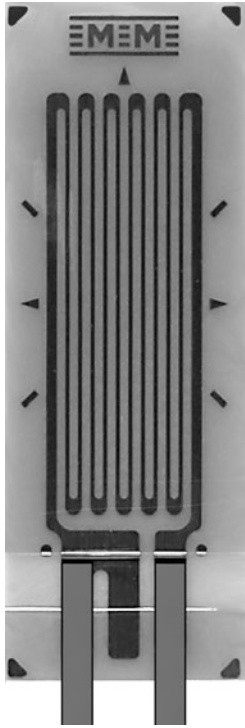

Note 3: Products with designations and options shown in **bold** are not RoHS compliant.

*Options available but not normally recommended. See Optional Features datasheet for details.

General Purpose Strain Gages – Linear Pattern

GAGE PATTERN DATA					
		GAGE DESIGNATION See Note 1		RESISTANCE (OHMS)	OPTIONS AVAILABLE
		L2A-XX-250LW-120 L2A-XX-250LW-350 C2A-XX-250LW-120 C2A-XX-250LW-350		120 ± 0.6% 350 ± 0.6% 120 ± 0.6% 350 ± 0.6%	
				actual size	
		DESCRIPTION Widely used general-purpose gage.			 RoHS COMPLIANT
GAGE DIMENSIONS		Legend ES = Each Section CP = Complete Pattern S = Section (S1 = Section 1) M = Matrix			
				<input type="checkbox"/> inch <input type="checkbox"/> millimeter	
Gage Length	Overall Length	Grid Width	Overall Width	Matrix Length	Matrix Width
0.250	0.363	0.100	0.100	0.440	0.170
6.35	9.22	2.54	2.54	11.18	4.32

GAGE SERIES DATA — See Gage Series datasheet for complete specifications			
Series	Description	Strain Range	Temperature Range
L2A	Encapsulated constantan gages with preattached ribbon leads.	±3%	-100° to +250°F (-75° to +120°C)
C2A	Encapsulated constantan gages with preattached ready-to-use cables.	±3%	-60° to +180°F (-50° to +80°C)

	
Example of an L2A Construction	Example of a C2A Construction

Note 1: Insert desired S-T-C number in spaces marked XX.

General Purpose Strain Gages – Linear Pattern

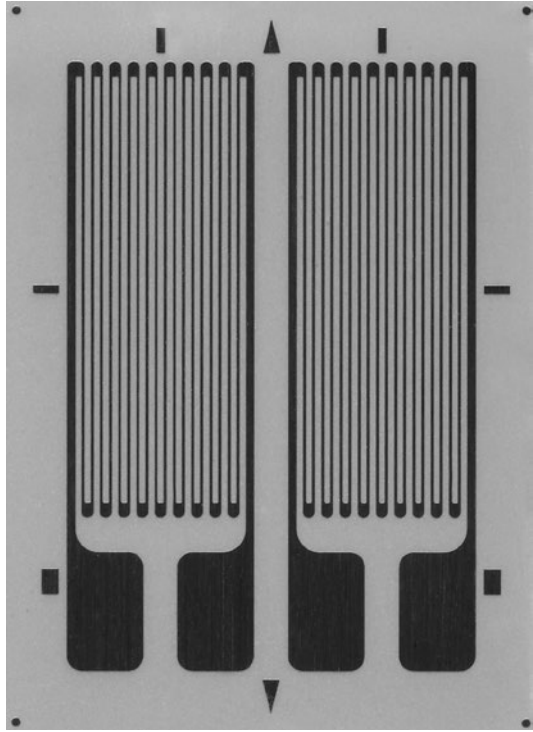
GAGE PATTERN DATA							
 <p style="text-align: center;">actual size</p>		GAGE DESIGNATION See Note 1, 3	RESISTANCE (OHMS) See Note 2	OPTIONS AVAILABLE See Note 3			
		EA-XX-250PD-120 EA-XX-250PD-350 ED-DY-250PD-350 EK-XX-250PD-10C S2K-XX-250PD-10C WA-XX-250PD-120 WA-XX-250PD-350 WK-XX-250PD-350 WK-XX-250PD-10C SA-XX-250PD-120 SA-XX-250PD-350 SK-XX-250PD-350 SK-XX-250PD-10C SD-DY-250PD-350 WD-DY-250PD-350	120 ± 0.2% 350 ± 0.2% 350 ± 0.4% 1000 ± 0.2% 1000 ± 0.4% 120 ± 0.3% 350 ± 0.3% 350 ± 0.4% 1000 ± 0.4% 120 ± 0.4% 350 ± 0.4% 350 ± 0.4% 1000 ± 0.4% 350 ± 0.8% 350 ± 0.8%	W, E, L, LE W, E, L, LE E W, SE W* W* W* W*			
DESCRIPTION Dual-element pattern with longitudinal grid centerlines spaced 0.130 in [3.30 mm] apart. See also 250MQ pattern. EK-Series gages are supplied with duplex copper pads (DP) when optional feature W or SE is not specified.							
GAGE DIMENSIONS		Legend ES = Each Section CP = Complete Pattern S = Section (S1 = Section 1) M = Matrix					
				<table border="1"> <tr><td>inch</td></tr> <tr><td>millimeter</td></tr> </table>		inch	millimeter
inch							
millimeter							
Gage Length	Overall Length	Grid Width	Overall Width	Matrix Length	Matrix Width		
0.250	0.358	0.110	0.240	0.44	0.32		
6.35	9.09	2.79	6.10	11.2	8.1		

GAGE SERIES DATA — See Gage Series datasheet for complete specifications			
Series	Description	Strain Range	Temperature Range
EA	Constantan foil in combination with a tough, flexible, polyimide backing.	±5%	-100° to +350°F (-75° to +175°C)
ED	Isoelastic foil in combination with tough, flexible polyimide film.	±2%	-320° to +400°F (-195° to +205°C)
EK	K-alloy foil in combination with a tough, flexible polyimide backing.	±1.5%	-320° to +350°F (-195° to +175°C)
S2K	K-alloy foil with laminated thick, high-performance polyimide backing.	±1.5%	-100° to +250°F (-75° to +120°C)
WA	Fully encapsulated constantan gages with high-endurance leadwires.	±2%	-100° to +400°F (-75° to +205°)
WK	Fully encapsulated K-alloy gages with high-endurance leadwires.	±1.5%	-452° to +550°F (-269° to +290°C)
SA	Fully encapsulated constantan gages with solder dots.	±2%	-100° to +400°F (-75° to +205°C)
SK	Fully encapsulated K-alloy gages with solder dots.	±1.5%	-452° to +450°F (-269° to +230°C)
SD	Equivalent to WD Series, but with solder dots instead of leadwires.	±1.5%	-320° to +400°F (-195° to +205°C)
WD	Fully encapsulated isoelastic gages with high-endurance leadwires.	±1.5%	-320° to +500°F (-195° to +260°C)

Note 1: Insert desired S-T-C number in spaces marked XX.

Note 2: Tolerance is increased when Option W, E, SE, LE, or P is specified.

Note 3: Products with designations and options shown in **bold** are not RoHS compliant.

*Options available but not normally recommended. See Optional Features datasheet for details.

General Purpose Strain Gages – Linear Pattern

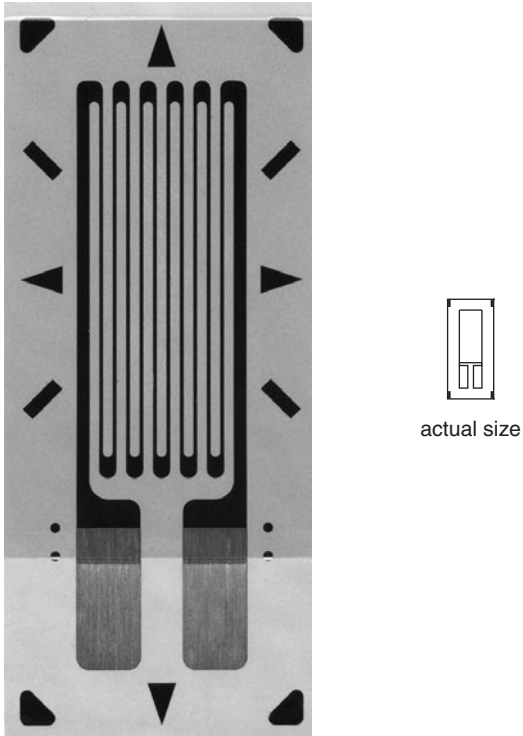
GAGE PATTERN DATA					
			GAGE DESIGNATION See Note 1	RESISTANCE (OHMS)	OPTIONS AVAILABLE See Note 2
			CEA-XX-250UN-120 CEA-XX-250UN-350	120 ± 0.3% 350 ± 0.3%	P2 P2
DESCRIPTION General-purpose gage with narrow geometry. Exposed solder tab area 0.08 x 0.05 in (2.0 x 1.1 mm). See also 250UW pattern.					
GAGE DIMENSIONS		Legend ES = Each Section CP = Complete Pattern S = Section (S1 = Section 1) M = Matrix			<input type="checkbox"/> inch <input type="checkbox"/> millimeter
Gage Length	Overall Length	Grid Width	Overall Width	Matrix Length	Matrix Width
0.250	0.415	0.120	0.120	0.52	0.22
6.35	10.54	3.05	3.05	13.2	5.6

GAGE SERIES DATA — See Gage Series datasheet for complete specifications

Series	Description	Strain Range	Temperature Range
CEA	Universal general-purpose strain gages.	±5%	-100° to +350°F (-75° to +175°C)

Note 1: Insert desired S-T-C number in spaces marked XX.

Note 2: Products with designations and options shown in **bold** are not RoHS compliant.

General Purpose Strain Gages – Linear Pattern

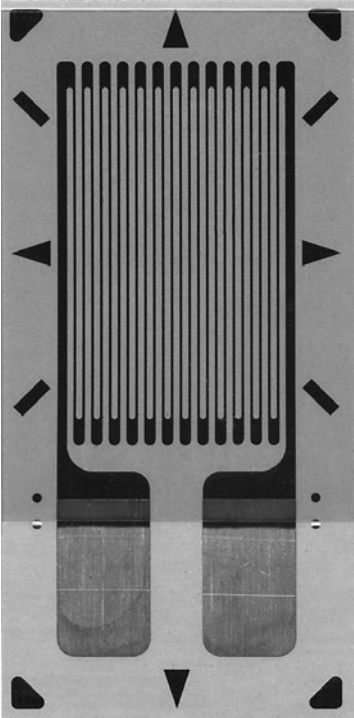
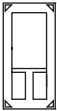
GAGE PATTERN DATA																							
  actual size	GAGE DESIGNATION See Note 1	RESISTANCE (OHMS)	OPTIONS AVAILABLE See Note 2																				
	CEA-XX-250UW-120 CEA-XX-250UW-175 CEA-XX-250UW-350 CEA-XX-250UW-10C	120 ± 0.3% 175 ± 0.3% 350 ± 0.3% 1000 ± 0.3%	P2 P2 P2 P2																				
DESCRIPTION General-purpose gage. Exposed solder tab area 0.10 x 0.07 in (2.5 x 1.8 mm). See also 250UN pattern.																							
GAGE DIMENSIONS		Legend ES = Each Section CP = Complete Pattern S = Section (S1 = Section 1) M = Matrix																					
				<table border="1"> <tr> <td>inch</td> </tr> <tr> <td>millimeter</td> </tr> </table>		inch	millimeter																
inch																							
millimeter																							
<table border="1"> <thead> <tr> <th>Gage Length</th> <th>Overall Length</th> <th>Grid Width</th> <th>Overall Width</th> <th>Matrix Length</th> <th>Matrix Width</th> </tr> </thead> <tbody> <tr> <td>0.250</td> <td>0.450</td> <td>0.180</td> <td>0.180</td> <td>0.55</td> <td>0.27</td> </tr> <tr> <td>6.35</td> <td>11.43</td> <td>4.57</td> <td>4.57</td> <td>14.0</td> <td>6.9</td> </tr> </tbody> </table>	Gage Length	Overall Length	Grid Width	Overall Width	Matrix Length	Matrix Width	0.250	0.450	0.180	0.180	0.55	0.27	6.35	11.43	4.57	4.57	14.0	6.9					
Gage Length	Overall Length	Grid Width	Overall Width	Matrix Length	Matrix Width																		
0.250	0.450	0.180	0.180	0.55	0.27																		
6.35	11.43	4.57	4.57	14.0	6.9																		

GAGE SERIES DATA — See Gage Series datasheet for complete specifications			
Series	Description	Strain Range	Temperature Range
CEA	Universal general-purpose strain gages.	±5%	-100° to +350°F (-75° to +175°C)

Note 1: Insert desired S-T-C number in spaces marked XX.

Note 2: Products with designations and options shown in **bold** are not RoHS compliant.

General Purpose Strain Gages – Linear Pattern

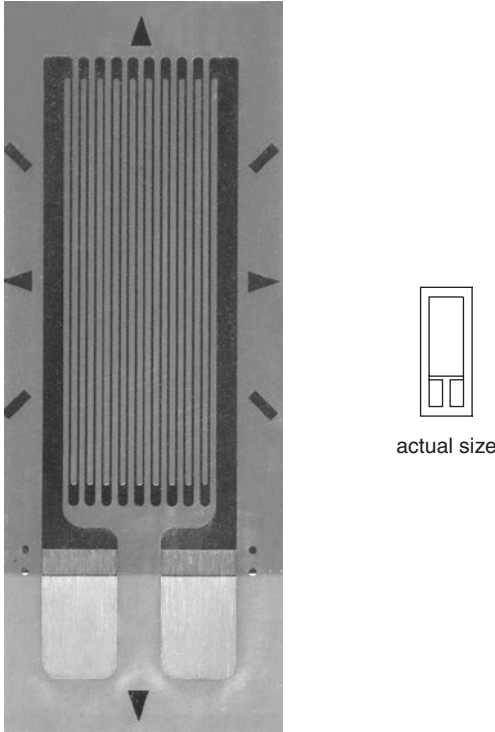
GAGE PATTERN DATA					
		GAGE DESIGNATION See Note 1	RESISTANCE (OHMS)	OPTIONS AVAILABLE See Note 2	
		CEA-XX-375UW-120 CEA-XX-375UW-350	120 ± 0.3% 350 ± 0.3%	P2 P2	
DESCRIPTION General-purpose gage. Exposed solder tab area 0.10 x 0.07 in (2.5 x 1.8 mm).					
GAGE DIMENSIONS		Legend ES = Each Section CP = Complete Pattern S = Section (S1 = Section 1) M = Matrix			<input type="checkbox"/> inch <input type="checkbox"/> millimeter
Gage Length	Overall Length	Grid Width	Overall Width	Matrix Length	Matrix Width
0.375	0.575	0.180	0.180	0.67	0.27
9.53	14.61	4.57	4.57	17.0	6.9

GAGE SERIES DATA — See Gage Series datasheet for complete specifications			
Series	Description	Strain Range	Temperature Range
CEA	Universal general-purpose strain gages.	±5%	-100° to +350°F (-75° to +175°C)

Note 1: Insert desired S-T-C number in spaces marked XX.

Note 2: Products with designations and options shown in **bold** are not RoHS compliant.

General Purpose Strain Gages – Linear Pattern

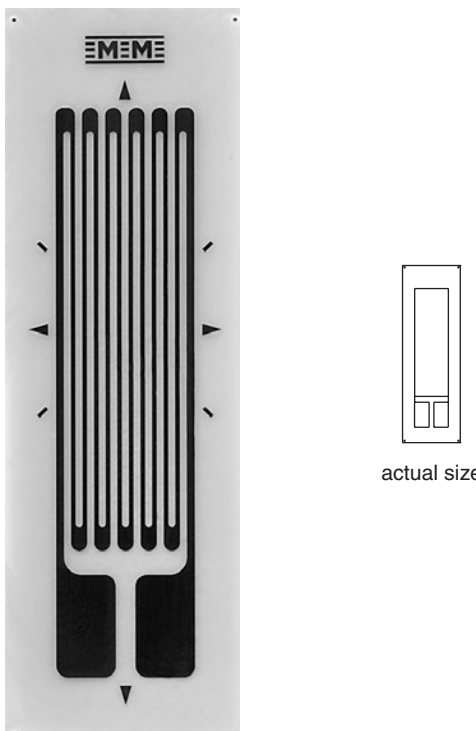
GAGE PATTERN DATA							
 <p>actual size</p>		GAGE DESIGNATION See Note 1, 3	RESISTANCE (OHMS) See Note 2	OPTIONS AVAILABLE See Note 3			
		EA-XX-500BH-120 ED-DY-500BH-350 WA-XX-500BH-120 WK-XX-500BH-350 EP-08-500BH-120 SA-XX-500BH-120 SK-XX-500BH-350 SD-DY-500BH-350 WD-DY-500BH-350	120 ± 0.15% 350 ± 0.3% 120 ± 0.3% 350 ± 0.3% 120 ± 0.15% 120 ± 0.3% 350 ± 0.3% 350 ± 0.6% 350 ± 0.6%	W, E, L, LE, P E, L*, LE* W* W*			
DESCRIPTION Widely used general-purpose gage with compact geometry. See also 500BL and 500UW patterns.							
GAGE DIMENSIONS		Legend ES = Each Section CP = Complete Pattern S = Section (S1 = Section 1) M = Matrix					
				<table border="1"> <tr><td>inch</td></tr> <tr><td>millimeter</td></tr> </table>	inch	millimeter	
inch							
millimeter							
Gage Length	Overall Length	Grid Width	Overall Width	Matrix Length	Matrix Width		
0.500	0.720	0.175	0.175	0.92	0.30		
12.70	18.29	4.45	4.45	23.4	7.6		

GAGE SERIES DATA — See Gage Series datasheet for complete specifications			
Series	Description	Strain Range	Temperature Range
EA	Constantan foil in combination with a tough, flexible, polyimide backing.	±5%	-100° to +350°F (-75° to +175°C)
ED	Isoelastic foil in combination with tough, flexible polyimide film.	±2%	-320° to +400°F (-195° to +205°C)
WA	Fully encapsulated constantan gages with high-endurance leadwires.	±2%	-100° to +400°F (-75° to +205°)
WK	Fully encapsulated K-alloy gages with high-endurance leadwires.	±1.5%	-452° to +550°F (-269° to +290°C)
EP	Annealed constantan foil with tough, high-elongation polyimide backing.	±20%	-100° to +400°F (-75° to +205°C)
SA	Fully encapsulated constantan gages with solder dots.	±2%	-100° to +400°F (-75° to +205°C)
SK	Fully encapsulated K-alloy gages with solder dots.	±1.5%	-452° to +450°F (-269° to +230°C)
SD	Equivalent to WD Series, but with solder dots instead of leadwires.	±1.5%	-320° to +400°F (-195° to +205°C)
WD	Fully encapsulated isoelastic gages with high-endurance leadwires.	±1.5%	-320° to +500°F (-195° to +260°C)



Note 1: Insert desired S-T-C number in spaces marked XX.

Note 2: Tolerance is increased when Option W, E, SE, LE, or P is specified.

Note 3: Products with designations and options shown in **bold** are not RoHS compliant.

*Options available but not normally recommended. See Optional Features datasheet for details.

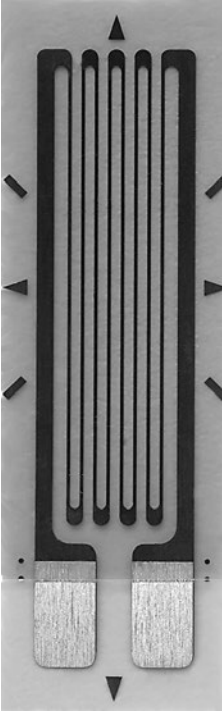
General Purpose Strain Gages – Linear Pattern

GAGE PATTERN DATA							
		<p>GAGE DESIGNATION See Note 1</p>		<p>RESISTANCE (OHMS)</p>	<p>OPTIONS AVAILABLE See Note 2</p>		
		<p>CEA-XX-500UW-120 CEA-XX-500UW-350</p>		<p>120 ± 0.3% 350 ± 0.3%</p>	<p>P2 P2</p>		
 <p>actual size</p>		<p>DESCRIPTION</p> <p>General-purpose gage. Exposed solder tab area 0.10 x 0.07 in (2.5 x 1.8 mm).</p>					
		<p>GAGE DIMENSIONS</p>		<p>Legend</p> <p>ES = Each Section CP = Complete Pattern S = Section (S1 = Section 1) M = Matrix</p>		<table border="1"> <tr> <td>inch</td> </tr> <tr> <td>millimeter</td> </tr> </table>	
inch							
millimeter							
Gage Length	Overall Length	Grid Width	Overall Width	Matrix Length	Matrix Width		
0.500	0.700	0.180	0.180	0.80	0.27		
12.70	17.78	4.57	4.57	20.3	6.9		

GAGE SERIES DATA — See Gage Series datasheet for complete specifications

Series	Description	Strain Range	Temperature Range
CEA	Universal general-purpose strain gages.	±5%	-100° to +350°F (-75° to +175°C)

Note 1: Insert desired S-T-C number in spaces marked XX.

Note 2: Tolerance is increased when Option W, E, SE, LE, or P is specified.

General Purpose Strain Gages – Linear Pattern

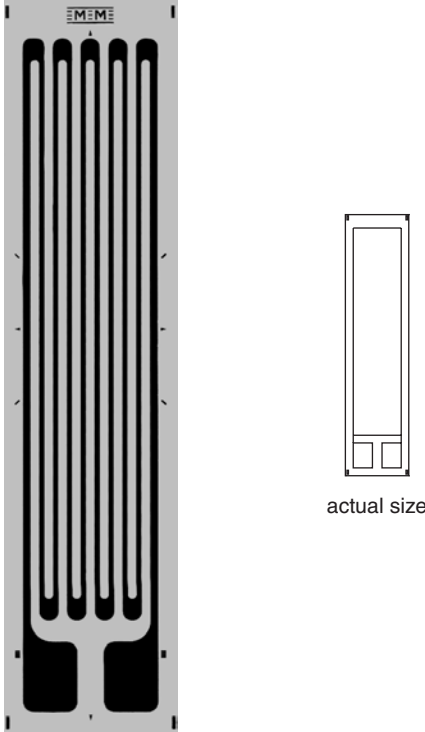
GAGE PATTERN DATA					
		GAGE DESIGNATION See Note 1, 3	RESISTANCE (OHMS) See Note 2	OPTIONS AVAILABLE See Note 3	
		N2A-XX-10CBE-120 N2A-XX-10CBE-350 EA-XX-10CBE-120 WA-XX-10CBE-120 WK-XX-10CBE-350 EP-XX-10CBE-120 SA-XX-10CBE-120 SK-XX-10CBE-350	120 ± 0.15% 350 ± 0.15% 120 ± 0.15% 120 ± 0.3% 350 ± 0.3% 120 ± 0.15% 120 ± 0.3% 350 ± 0.3%	W, E, L, LE, P W, E, L, LE, P W, E, L, LE, P W* W*	
DESCRIPTION Large general-purpose gage.					
GAGE DIMENSIONS		Legend ES = Each Section CP = Complete Pattern S = Section (S1 = Section 1) M = Matrix			<input type="checkbox"/> inch <input type="checkbox"/> millimeter
Gage Length	Overall Length	Grid Width	Overall Width	Matrix Length	Matrix Width
1.000	1.250	0.250	0.250	1.36	0.33
25.40	31.75	6.35	6.35	34.5	8.4

GAGE SERIES DATA — See Gage Series datasheet for complete specifications			
Series	Description	Strain Range	Temperature Range
N2A	Constantan foil gages with a thin, laminated, polyimide-film backing.	±3%	-100° to +200°F (-75° to +95°C)
EA	Constantan foil in combination with a tough, flexible, polyimide backing.	±5%	-100° to +350°F (-75° to +175°C)
WA	Fully encapsulated constantan gages with high-endurance leadwires.	±2%	-100° to +400°F (-75° to +205°)
WK	Fully encapsulated K-alloy gages with high-endurance leadwires.	±1.5%	-452° to +550°F (-269° to +290°C)
EP	Annealed constantan foil with tough, high-elongation polyimide backing.	±20%	-100° to +400°F (-75° to +205°C)
SA	Fully encapsulated constantan gages with solder dots.	±2%	-100° to +400°F (-75° to +205°C)
SK	Fully encapsulated K-alloy gages with solder dots.	±1.5%	-452° to +450°F (-269° to +230°C)

Note 1: Insert desired S-T-C number in spaces marked XX.

Note 2: Tolerance is increased when Option W, E, SE, LE, or P is specified.

Note 3: Products with designations and options shown in **bold** are not RoHS compliant.

*Options available but not normally recommended. See Optional Features datasheet for details.

General Purpose Strain Gages – Linear Pattern

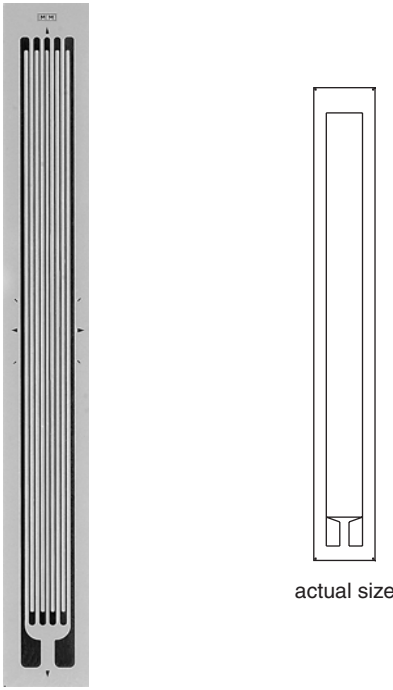
GAGE PATTERN DATA							
		GAGE DESIGNATION See Note 1, 3	RESISTANCE (OHMS) See Note 2	OPTIONS AVAILABLE See Note 3			
		N2A-XX-20CBW-120 N2A-XX-20CBW-350 EA-XX-20CBW-120 WA-XX-20CBW-120 WK-XX-20CBW-350 EP-XX-20CBW-120 SA-XX-20CBW-120 SK-XX-20CBW-350	120 ± 0.2% 350 ± 0.2% 120 ± 0.2% 350 ± 0.4% 120 ± 0.4% 350 ± 0.2% 120 ± 0.4% 350 ± 0.4%	W, E, L, LE, P W, E, L, LE, P W, E, L, LE, P W* W*			
DESCRIPTION For use on concrete and for strain integration on large specimens.							
GAGE DIMENSIONS		Legend			<table border="1"> <tr><td>inch</td></tr> <tr><td>millimeter</td></tr> </table>	inch	millimeter
inch							
millimeter							
		ES = Each Section	CP = Complete Pattern				
		S = Section (S1 = Section 1)	M = Matrix				
Gage Length	Overall Length	Grid Width	Overall Width	Matrix Length	Matrix Width		
2.000	2.250	0.188	0.188	2.46	0.32		
50.80	57.15	4.78	4.78	62.5	8.1		

GAGE SERIES DATA — See Gage Series datasheet for complete specifications			
Series	Description	Strain Range	Temperature Range
N2A	Constantan foil gages with a thin, laminated, polyimide-film backing.	±3%	-100° to +200°F (-75° to +95°C)
EA	Constantan foil in combination with a tough, flexible, polyimide backing.	±5%	-100° to +350°F (-75° to +175°C)
WA	Fully encapsulated constantan gages with high-endurance leadwires.	±2%	-100° to +400°F (-75° to +205°)
WK	Fully encapsulated K-alloy gages with high-endurance leadwires.	±1.5%	-452° to +550°F (-269° to +290°C)
EP	Annealed constantan foil with tough, high-elongation polyimide backing.	±20%	-100° to +400°F (-75° to +205°C)
SA	Fully encapsulated constantan gages with solder dots.	±2%	-100° to +400°F (-75° to +205°C)
SK	Fully encapsulated K-alloy gages with solder dots.	±1.5%	-452° to +450°F (-269° to +230°C)



Note 1: Insert desired S-T-C number in spaces marked XX.

Note 2: Tolerance is increased when Option W, E, SE, LE, or P is specified.

Note 3: Products with designations and options shown in **bold** are not RoHS compliant.

*Options available but not normally recommended. See Optional Features datasheet for details.

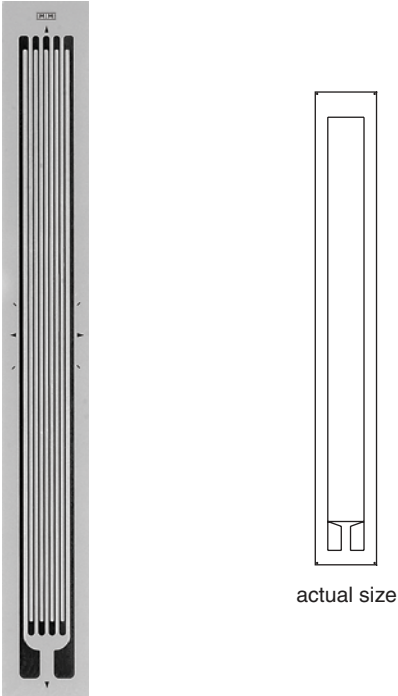









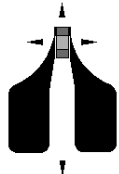

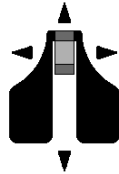
General Purpose Strain Gages – Linear Pattern

GAGE PATTERN DATA					
			GAGE DESIGNATION See Note 1	RESISTANCE (OHMS)	OPTIONS AVAILABLE
			C2A-XX-20CLW-120 C2A-XX-20CLW-350	120 ± 0.6% 350 ± 0.6%	
DESCRIPTION For use on concrete and for strain integration on large specimens.					
GAGE DIMENSIONS		Legend ES = Each Section CP = Complete Pattern S = Section (S1 = Section 1) M = Matrix			<input type="checkbox"/> inch <input type="checkbox"/> millimeter
Gage Length	Overall Length	Grid Width	Overall Width	Matrix Length	Matrix Width
2.000	2.155	0.175	0.175	2.232	0.235
50.80	54.740	4.450	4.450	56.692	5.969

GAGE SERIES DATA — See Gage Series datasheet for complete specifications			
Series	Description	Strain Range	Temperature Range
C2A	Encapsulated constantan gages with preattached ready-to-use cables.	±3%	-60° to +180°F (-50° to +80°C)
 Example of a C2A Construction			

Note 1: Insert desired S-T-C number in spaces marked XX.

General Purpose Strain Gages











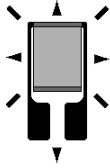

GAGE PATTERN	GAGE SERIES See Note 1	GAGE RESISTANCE (OHMS)	GAGE LENGTH	
			inches	millimeters
008CL   actual size	SA	120	0.008	0.2
	Micro-grid gage for strain measurement in high-gradient areas. Matrix size: 0.20L x 0.13W in. (5.1L x 3.3W mm)			
015CK   actual size	EA, WA, EP, SA	120	0.015	0.38
	Micro-miniature pattern with enlarged solder tabs. See also 015UW pattern. Matrix size: 0.19L x 0.15W in. (4.8L x 3.8W mm)			
015EH   actual size	EA, EP, SA, SK	120	0.015	0.38
	Micro-miniature pattern with tab at each side of grid. Matrix size: 0.15L x 0.19W in. (3.8L x 4.8W mm)			
015LA   actual size	EA, EP	120	0.015	0.38
	Primarily used in small radii where gage tabs must be at one end. Matrix size: 0.18L x 0.10W in. (4.6L x 2.5W mm)			
015SE   actual size	EA, EP, SA	120	0.015	0.38
	Micro-miniature pattern with tabs on one side for use near abutments. Matrix size: 0.16L x 0.14W in. (4.1L x 3.6W mm)			
030LB   actual size	EA, EP, SA	120	0.03	0.76
	Miniature gage pattern for small radii where gage tabs must be at one end. Matrix size: 0.24L x 0.15W in. (6.1L x 3.8W mm)			

Note 1: Products with designations and options shown in **bold** are not RoHS compliant.

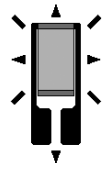
See www.micro-measurements.com/stress-analysis-strain-gages/other-linear-patterns/ for complete specifications of patterns listed.

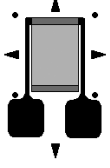
For all linear patterns offered, see www.micro-measurements.com/stress-analysis-strain-gages/all-linear-patterns/

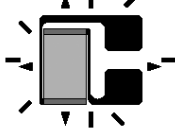
General Purpose Strain Gages











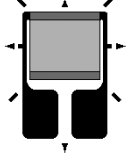

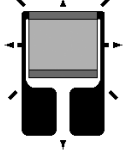
GAGE PATTERN	GAGE SERIES See Note 1	GAGE RESISTANCE (OHMS)	GAGE LENGTH	
			inches	millimeters
031MF   actual size	EA, SA	120	0.031	0.79
Miniature ten-element strip gage with electrically independent grids. All grids parallel to long axis of pattern. Grid centerline spacing 0.080 in (2.03 mm). Matrix size: 0.94L x 0.19W in. (23.9L x 4.8W mm)				
032SG   actual size	EA, WA, WK, EP, SA, SK	120	0.032	0.81
Miniature gage with side-tab geometry. Matrix size: 0.16L x 0.19W in. (4.1L x 4.8W mm)				
045AL   actual size	EA, SA	350	0.045	1.14
Miniature high-resistance gage. Matrix size: 0.22L x 0.14W in. (5.6L x 3.6W mm)				
050AH   actual size	EA, ED, EP, SA, SK, SD	120, 350	0.05	1.27
General-purpose miniature gage. Matrix size: 0.23L x 0.14W in. (5.8L x 3.6W mm)				
050AR   actual size	EA, ED, WA, WK, SA, SK, SD, WD	120, 350	0.05	1.27
General-purpose miniature gage with large solder tabs. Matrix size: 0.25L x 0.18W in. (6.4L x 4.6W mm)				
050SB   actual size	EA, ED, WA, WK, EP, SA, SK, SD, WD	120, 350	0.05	1.27
Similar to the 050AH pattern but with solder tabs at side of grid. Matrix size: 0.19L x 0.19W in. (4.8L x 4.8W mm)				

Note 1: Products with designations and options shown in **bold** are not RoHS compliant.

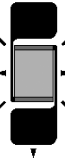
See www.micro-measurements.com/stress-analysis-strain-gages/other-linear-patterns/ for complete specifications of patterns listed.

For all linear patterns offered, see www.micro-measurements.com/stress-analysis-strain-gages/all-linear-patterns/

General Purpose Strain Gages











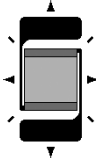

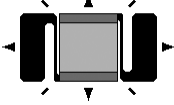
GAGE PATTERN	GAGE SERIES See Note 1	GAGE RESISTANCE (OHMS)	GAGE LENGTH	
			inches	millimeters
060CD   actual size	EA, ED, WA , WK, SA , SK , SD , WD	350, 1000	0.06	1.52
060CN   actual size	EA, ED, WA , WK, EP, SA , SD , WD	120, 350	0.06	1.52
060CP   actual size	EA, ED, WA , WK, EP, SA , SK , SD , WD	120, 350	0.06	1.52
062DF   actual size	EA, ED, WA , WK, EP, SA , SK , SD , WD	120, 350	0.062	1.57
070LC   actual size	EA	120, 350	0.07	1.78
090DG   actual size	EA, ED, EP, SA , SK , SD	120, 350	0.09	2.29

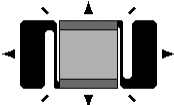
Note 1: Products with designations and options shown in **bold** are not RoHS compliant.

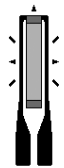
See www.micro-measurements.com/stress-analysis-strain-gages/other-linear-patterns/ for complete specifications of patterns listed.

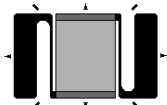
For all linear patterns offered, see www.micro-measurements.com/stress-analysis-strain-gages/all-linear-patterns/

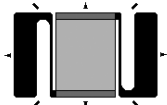
General Purpose Strain Gages







GAGE PATTERN	GAGE SERIES See Note 1	GAGE RESISTANCE (OHMS)	GAGE LENGTH	
			inches	millimeters
090DH   actual size	EA, ED, EP, SA, SK, SD	350, 1000	0.09	2.29
090EF   actual size	EA, ED, EP, SA, SK, SD	120, 350	0.09	2.29
090EG   actual size	EA, ED, EP, SA, SK, SD	350, 1000	0.09	2.29
125BS   actual size	ED, WK, SK, SD , WD	120	0.125	3.18
125EP   actual size	EA, ED, EP, SA, SK, SD	350, 1000	0.125	3.18
125EQ   actual size	EA, ED, EP, SA, SK, SD	120, 350	0.125	3.18

Note 1: Products with designations and options shown in **bold** are not RoHS compliant.

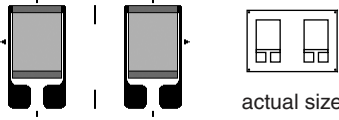
See www.micro-measurements.com/stress-analysis-strain-gages/other-linear-patterns/ for complete specifications of patterns listed.

For all linear patterns offered, see www.micro-measurements.com/stress-analysis-strain-gages/all-linear-patterns/

General Purpose Strain Gages





GAGE PATTERN	GAGE SERIES See Note 1	GAGE RESISTANCE (OHMS)	GAGE LENGTH	
			inches	millimeters
125MG  actual size	EA, WA , WK, SA , SK	120, 350	0.125	3.18
Dual-pattern gage for use in back-to-back bending applications. Longitudinal grid centerlines spaced 0.250 in (6.35 mm) apart. Matrix size: 0.32L x 0.47W in. (8.1L x 11.9W mm)				
125UE  actual size	CEA	120, 350	0.125	3.18
General-purpose gage with large tab at each end of grid. Exposed solder tab area 0.08 x 0.07 in (2.0 x 1.8 mm). Matrix size: 0.57L x 0.20W in. (14.5L x 5.1W mm)				
230DS  actual size	EA, ED, WA , WK, EP, SA , SK , SD , WD	120, 350	0.23	5.84
General-purpose gage with very narrow geometry. Matrix size: 0.50L x 0.12W in. (12.7L x 3.0W mm)				
250AF  actual size	EA, ED, WA , WK, EP, SA , SK , SD , WD	120, 350	0.25	6.35
General-purpose gage with high-dissipation grid. Matrix size: 0.57L x 0.36W in. (14.5L x 9.1W mm)				
250BB  actual size	EA, ED, EP	120, 350	0.25	6.35
General-purpose gage with large solder tabs. Matrix size: 0.64L x 0.21W in. (16.3L x 6.9W mm)				
250BK  actual size	EA, WA , WK, SA , SK	1000, 3000	0.25	6.35
High-resistance gage with good power dissipation capability for high output applications or use on plastics. Matrix size: 0.58L x 0.27W in. (14.7L x 6.9W mm)				

Note 1: Products with designations and options shown in **bold** are not RoHS compliant.

See www.micro-measurements.com/stress-analysis-strain-gages/other-linear-patterns/ for complete specifications of patterns listed.

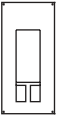
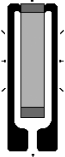
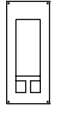
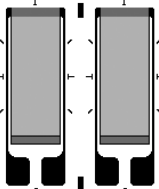
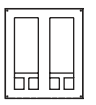
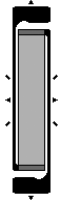
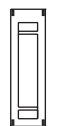
For all linear patterns offered, see www.micro-measurements.com/stress-analysis-strain-gages/all-linear-patterns/

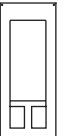
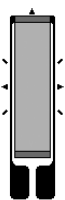
General Purpose Strain Gages

GAGE PATTERN	GAGE SERIES See Note 1	GAGE RESISTANCE (OHMS)	GAGE LENGTH	
			inches	millimeters
250BM   <p>actual size</p>	EA, ED, WA , WK, EP, SA, SK, SD , WD	500, 1500	0.25	6.35
	General-purpose gage with high-resistance grid. Matrix size: 0.58L x 0.27W in. (14.7L x 6.9W mm)			
250BP   <p>actual size</p>	SK , WK, ED, SD , WD	120	0.25	6.35
	A general-purpose gage used primarily to obtain 120-ohm grid resistance in SK and WK Series. Matrix size: 0.53L x 0.22W in. (13.5L x 5.6W mm)			
250MQ   <p>actual size</p>	EA, ED, EK, WA , WK, SA, SK, SD , WD	350, 1000	0.25	6.35
	Dual pattern for back-to-back bending applications. Longitudinal grid centerlines are spaced 0.185 in (4.70 mm) apart. EK-Series gages are supplied with duplex copper pads (DP) when optional feature W or SE is not specified. Matrix size: 0.47L x 0.40W in. (11.9L x 10.2W mm)			
350DD   <p>actual size</p>	EA, ED, WA , WK, EP, SA, SK, SD , WD	350, 1000	0.35	8.89
	General-purpose gage with narrow pattern geometry and tab at each end of grid. Matrix size: 0.61L x 0.18W in. (15.5L x 4.6W mm)			
375BG   <p>actual size</p>	EA, ED, WA , WK, EP, SA, SK, SD , WD	120, 350	0.375	9.53
	General-purpose gage. Matrix size: 0.71L x 0.29W in. (18.0L x 7.4W mm)			
500BL   <p>actual size</p>	EA, ED, WA , WK, EP, SA, SK, SD , WD	350, 1000	0.5	12.7
	Widely used general-purpose gage with compact geometry. Matrix size: 0.87L x 0.27W in. (22.1L x 6.9W mm)			

Note 1: Products with designations and options shown in **bold** are not RoHS compliant.

See www.micro-measurements.com/stress-analysis-strain-gages/other-linear-patterns/ for complete specifications of patterns listed.

For all linear patterns offered, see www.micro-measurements.com/stress-analysis-strain-gages/all-linear-patterns/

General Purpose Strain Gages

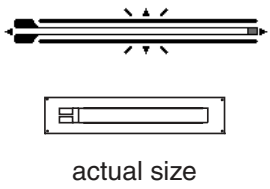
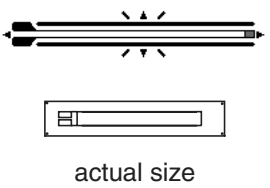
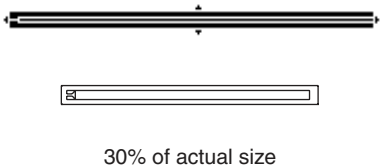
GAGE PATTERN	GAGE SERIES See Note 1	GAGE RESISTANCE (OHMS)	GAGE LENGTH	
			inches	millimeters
500GB  <p>actual size</p>	EA, ED, WA , WK, EP, SA, SK, SD , WD	120, 350	0.5	12.7
<p>General-purpose gage with very narrow geometry. See also 500GC pattern. Matrix size: 0.75L x 0.15W in. (19.1L x 3.8W mm)</p>				
500GC  <p>actual size</p>	EA, ED, WA , WK, EP, SA, SK, SD , WD	350, 1000	0.5	12.7
<p>General-purpose gage with very narrow geometry. Matrix size: 0.78L x 0.15W in. (19.8L x 3.8W mm)</p>				
40CBY  <p>30% of actual size</p>	N2A, EA, WA , WK, EP, SA, SK	120, 350	4	101.6
<p>For use on concrete and for strain integration on large specimens. Matrix size: 4.49L x 0.33W in. (114.0L x 8.4W mm)</p>				

Note 1: Products with designations and options shown in **bold** are not RoHS compliant.

See www.vishaypg.com/micro-measurements/stress-analysis-strain-gages/other-linear-patterns/ for complete specifications.

For all linear patterns offered, see www.micro-measurements.com/stress-analysis-strain-gages/all-linear-patterns/