

Rectangular Rosettes (General-Use)

FEATURES

- Gage patterns designed for determining principle stresses and strains
- All patterns have three grids oriented at 0°, 45° and 90° angles
- Both stacked and planar constructions available
- Gage lengths from 0.031" (0.79 mm) to 0.250" (6.35 mm)

PATTERNS

031RB	86
031WW	87
G1350	88
060WR	89
062LR	90
062UR	91
062WW	92
120WR	93
125LR	94
125RA	95
125UR	96
125WW	97
250LR	98
250UR	99
250WW	100
Other Rectangular Rosettes	101

General Purpose Strain Gages – Rectangular Pattern

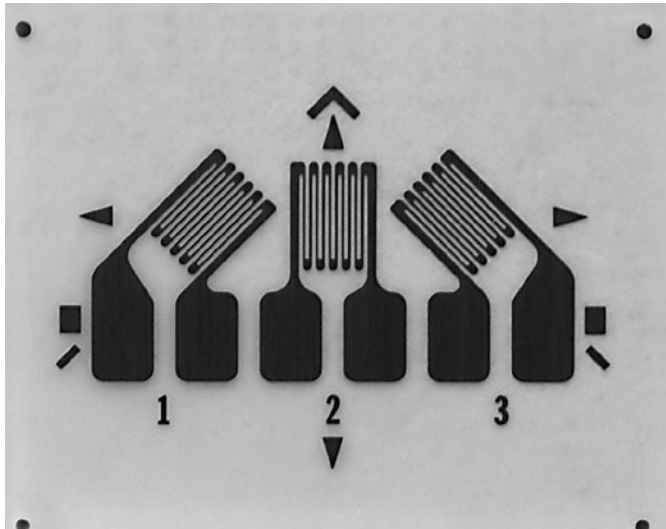
GAGE PATTERN DATA					
 <p style="text-align: center;">actual size</p>		GAGE DESIGNATION See Note 1, 3	RESISTANCE (OHMS) See Note 2	OPTIONS AVAILABLE See Note 3	
		EA-XX-031RB-120 EP-08-031RB-120 SA-XX-031RB-120	120 ± 0.4% 120 ± 0.4% 120 ± 0.8%	E, SE, L, LE	
DESCRIPTION Miniature 45° rectangular single-plane rosette with compact geometry.					
GAGE DIMENSIONS		Legend ES = Each Section CP = Complete Pattern S = Section (S1 = Section 1) M = Matrix			
				inch	millimeter
Gage Length	Overall Length	Grid Width	Overall Width	Matrix Length	Matrix Width
0.031ES	0.085 CP	0.031 ES	0.175 CP	0.19	0.30
0.79 ES	2.16 CP	0.79 ES	4.45 CP	4.8	6.1



GAGE SERIES DATA — See Gage Series datasheet for complete specifications			
Series	Description	Strain Range	Temperature Range
EA	Constantan foil in combination with a tough, flexible, polyimide backing.	±3%	-100° to +350°F (-75° to +175°C)
EP	Annealed constantan foil with tough, high-elongation polyimide backing.	±10%	-100° to +400°F (-75° to +205°C)
SA	Fully encapsulated constantan gages with solder dots.	±2%	-100° to +400°F (-75° to +205°C)

Note 1: Insert desired S-T-C number in spaces marked XX.

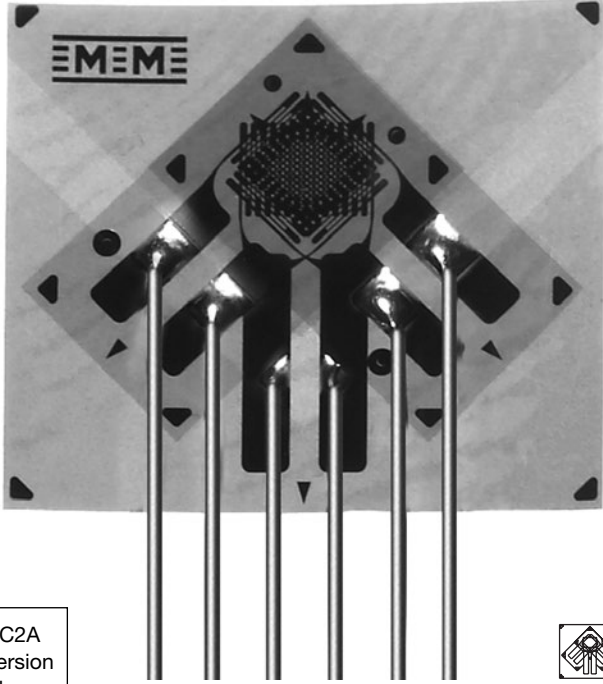

Note 2: Tolerance is increased when Option W, E, SE, LE, or P is specified.

Note 3: Products with designations and options shown in **bold** are not RoHS compliant.

General Purpose Strain Gages—Stacked Rosette

GAGE PATTERN DATA					
			GAGE DESIGNATION See Note 1	RESISTANCE (OHMS)	OPTIONS AVAILABLE
			L2A-XX-031WW-120 L2A-XX-031WW-350 C2A-XX-031WW-120 C2A-XX-031WW-350	120 ± 0.6% 350 ± 0.6% 120 ± 0.6% 350 ± 0.6%	
DESCRIPTION Stacked, 0°-45°-90° rosette for use in applications involving limited gaging areas or steep strain gradients.					
GAGE DIMENSIONS		Legend ES = Each Section CP = Complete Pattern S = Section (S1 = Section 1) M = Matrix			<input type="checkbox"/> inch <input type="checkbox"/> millimeter
Gage Length	Overall Length	Grid Width	Overall Width	Matrix Length	Matrix Width
0.031 ES	0.206 CP	0.070 ES	0.227 CP	0.278	0.315
0.79 ES	5.23 CP	1.79 ES	5.77 CP	7.06	8.00



GAGE SERIES DATA — See Gage Series datasheet for complete specifications			
Series	Description	Strain Range	Temperature Range (See Note 2)
L2A	Encapsulated constantan gages with preattached ribbon leads.	±3%	-100° to +150°F (-75° to +65°C)
C2A	Encapsulated constantan gages with preattached ready-to-use cables.	±3%	-60° to +150°F (-50° to +65°C)

 <p>Example of an L2A Construction</p>	 <p>Example of a C2A Construction</p>
---	---



Note 1: Insert desired S-T-C number in spaces marked XX.

Note 2: Upper use range is reduced to these values for stacked patterns.

General Purpose Strain Gages—Stacked Rosette

GAGE PATTERN DATA					
 <p style="text-align: center;">actual size</p>			GAGE DESIGNATION See Note 1	RESISTANCE (OHMS) 120 ± 0.6% 120 ± 0.6%	OPTIONS AVAILABLE
			L2A-XX-G1350-120/SP70* C2A-XX-G1350-120/SP70*		
DESCRIPTION Stacked, 0°-45°-90° rosette for use in applications involving limited gaging areas or steep strain gradients. The matrix has a circular trim (SP70).					 RoHS COMPLIANT
GAGE DIMENSIONS		Legend ES = Each Section CP = Complete Pattern S = Section (S1 = Section 1) M = Matrix			inch millimeter
Gage Length	Overall Length	Grid Width	Overall Width	Matrix Length	Matrix Width
0.040 ES	0.144 CP	0.045 ES	0.147 CP	0.20	0.20
1.0 ES	3.66 CP	1.14 ES	3.73 CP	5.1	5.1

GAGE SERIES DATA — See Gage Series datasheet for complete specifications			
Series	Description	Strain Range	Temperature Range
C2A	Encapsulated constantan gages with preattached ready-to-use cables.	±3%	-60° to +150°F (-50° to +66°C)

 <p>Example of an L2A Construction</p>	 <p>Example of an C2A Construction</p>
---	--

Note 1: Insert desired S-T-C number in spaces marked XX.

*SP70: circular trim of matrix.

General Purpose Strain Gages – Rectangular Rosette

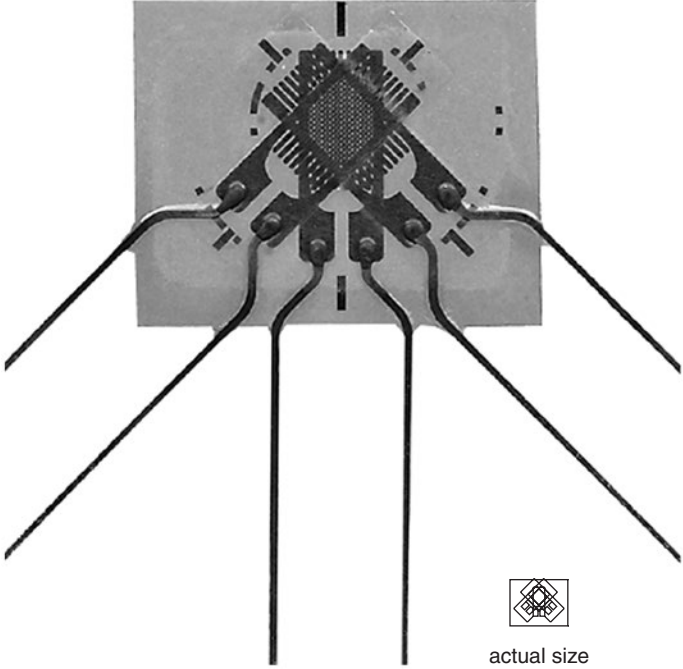

GAGE PATTERN DATA					
 <p style="text-align: center;">actual size</p>			GAGE DESIGNATION See Note 1, 2	RESISTANCE (OHMS)	OPTIONS AVAILABLE See Note 2
			WA-XX-060WR-120 WK-XX-060WR-120 WK-XX-060WR-350 WK-XX-060WR-10C SA-XX-060WR-120 SK-XX-060WR-120 SK-XX-060WR-350 SK-XX-060WR-10C	120 ± 0.5% 120 ± 0.5% 350 ± 0.5% 1000 ± 0.5% 120 ± 0.5% 120 ± 0.5% 350 ± 0.5% 1000 ± 0.5%	
DESCRIPTION Small three-element 45° rectangular stacked rosette					
GAGE DIMENSIONS		Legend ES = Each Section CP = Complete Pattern S = Section (S1 = Section 1) M = Matrix			
				inch	millimeter
Gage Length	Overall Length	Grid Width	Overall Width	Matrix Length	Matrix Width
0.060 ES	0.24 M	0.060 ES	0.30 M	0.24	0.30
1.52 ES	6.1 M	1.52 ES	7.6 M	6.1	7.6

GAGE SERIES DATA — See Gage Series datasheet for complete specifications			
Series	Description	Strain Range	Temperature Range
WA	Fully encapsulated constantan gages with high-endurance leadwires.	±2%	-100° to +400°F (-75° to +205°)
WK	Fully encapsulated K-alloy gages with high-endurance leadwires.	±1.5%	-452° to +550°F (-269° to +290°C)
SA	Fully encapsulated constantan gages with solder dots.	±2%	-100° to +400°F (-75° to +205°C)
SK	Fully encapsulated K-alloy gages with solder dots.	±1.5%	-452° to +450°F (-269° to +230°C)

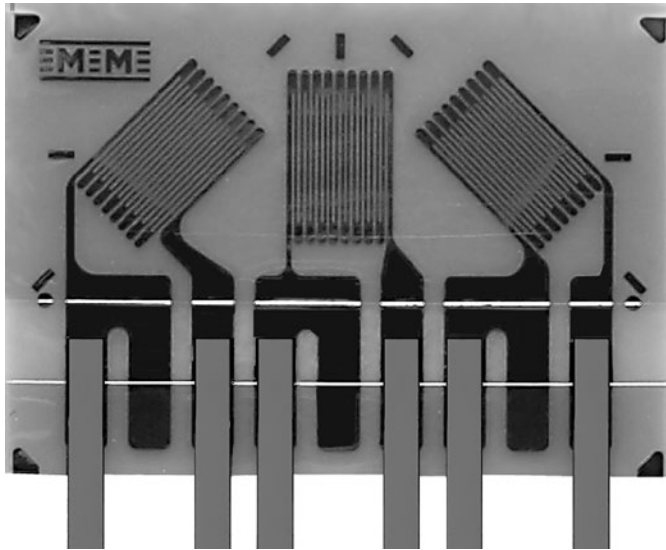

Note 1: Insert desired S-T-C number in spaces marked XX.

Note 2: Products with designations and options shown in bold are not RoHS compliant.

General Purpose Strain Gages – Rectangular Rosette

GAGE PATTERN DATA					
  actual size			GAGE DESIGNATION See Note 1	RESISTANCE (OHMS)	OPTIONS AVAILABLE
			L2A-XX-062LR-120 L2A-XX-062LR-350 C2A-XX062LR-120 C2A-XX-062LR-350	120 ± 0.6% 350 ± 0.6% 120 ± 0.6% 350 ± 0.6%	
DESCRIPTION Small 45° rectangular single-plane rosette.					 RoHS COMPLIANT
GAGE DIMENSIONS		Legend ES = Each Section S = Section (S1 = Section 1)			inch millimeter
				CP = Complete Pattern	
				M = Matrix	
Gage Length	Overall Length	Grid Width	Overall Width	Matrix Length	Matrix Width
0.062	0.185	0.050	0.260	0.277	0.410
1.52	4.70	1.27	6.60	7.04	10.41

GAGE SERIES DATA — See Gage Series datasheet for complete specifications			
Series	Description	Strain Range	Temperature Range
L2A	Encapsulated constantan gages with preattached ribbon leads.	±3%	-100° to +250°F (-75° to +120°C)
C2A	Encapsulated constantan gages with preattached ready-to-use cables.	±3%	-60° to +180°F (-50° to +80°C)

 Example of an L2A Construction	 Example of an C2A Construction
---	--

Note 1: Insert desired S-T-C number in spaces marked XX.

General Purpose Strain Gages – Rectangular Rosette

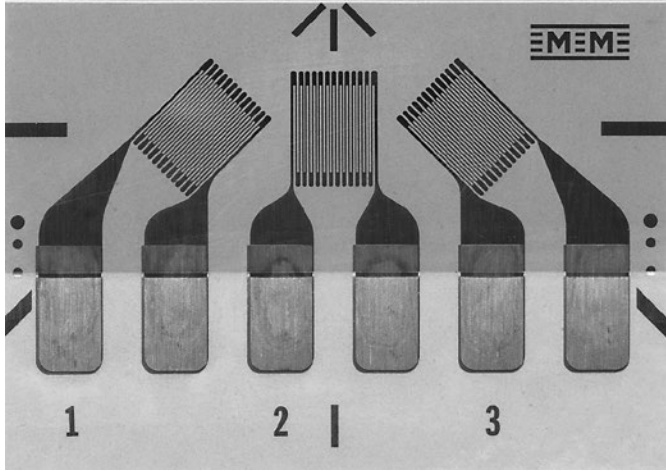
GAGE PATTERN DATA					
			GAGE DESIGNATION See Note 1	RESISTANCE (OHMS)	OPTIONS AVAILABLE See Note 2
			CEA-XX-062UR-120 CEA-XX-062UR-350	120 ± 0.4% 350 ± 0.4%	P2 P2
DESCRIPTION Small 45° rectangular single-plane rosette in a compact geometry. Exposed solder tab area 0.07 x 0.04 in (1.8 x 1.0 mm).					
GAGE DIMENSIONS		Legend ES = Each Section S = Section (S1 = Section 1)			<input type="checkbox"/> inch <input type="checkbox"/> millimeter
Gage Length	Overall Length	Grid Width	Overall Width	Matrix Length	Matrix Width
0.062 ES	0.222 CP	0.062 ES	0.420 CP	0.32	0.48
1.57 ES	5.64 CP	1.57 ES	10.67 CP	8.1	12.2



GAGE SERIES DATA — See Gage Series datasheet for complete specifications

Series	Description	Strain Range	Temperature Range
CEA	Universal general-purpose strain gages.	±3%	-100° to +350°F (-75° to +175°C)

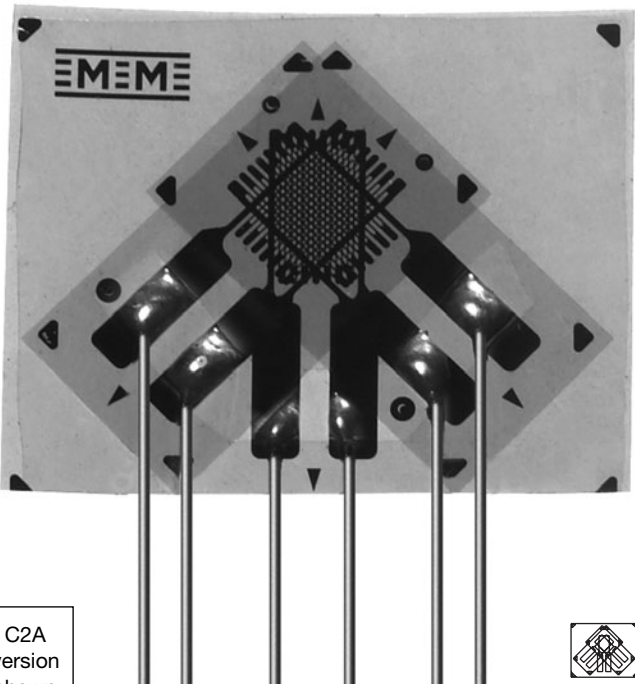

Note 1: Insert desired S-T-C number in spaces marked XX.

Note 2: Products with designations and options shown in bold are not RoHS compliant.

General Purpose Strain Gages—Stacked Rosette

GAGE PATTERN DATA					
 <p>C2A version shown</p> <p>actual size</p>			GAGE DESIGNATION See Note 1	RESISTANCE (OHMS)	OPTIONS AVAILABLE
			L2A-XX-062WW-120 L2A-XX-062WW-350 C2A-XX-062WW-120 C2A-XX-062WW-350	120 ± 0.6% 350 ± 0.6% 120 ± 0.6% 350 ± 0.6%	
DESCRIPTION Stacked, 0°-45°-90° rosette for use in applications involving limited gaging areas or steep strain gradients.					
GAGE DIMENSIONS		Legend ES = Each Section S = Section (S1 = Section 1)			inch millimeter
				CP = Complete Pattern	
				M = Matrix	
Gage Length	Overall Length	Grid Width	Overall Width	Matrix Length	Matrix Width
0.062 ES	0.180 CP	0.050 ES	0.235 CP	0.262	0.323
1.57 ES	4.57 CP	1.27 ES	6.00 CP	7.16	8.20

GAGE SERIES DATA — See Gage Series datasheet for complete specifications			
Series	Description	Strain Range	Temperature Range (See Note 2)
L2A	Encapsulated constantan gages with preattached ribbon leads.	±3%	-100° to +150°F (-75° to +65°C)
C2A	Encapsulated constantan gages with preattached ready-to-use cables.	±3%	-60° to +150°F (-50° to +65°C)

 <p>Example of an L2A Construction</p>	 <p>Example of an C2A Construction</p>
---	--

Note 1: Insert desired S-T-C number in spaces marked XX.

Note 2: Upper use range is reduced to these values for stacked patterns.

General Purpose Strain Gages – Rectangular Rosette

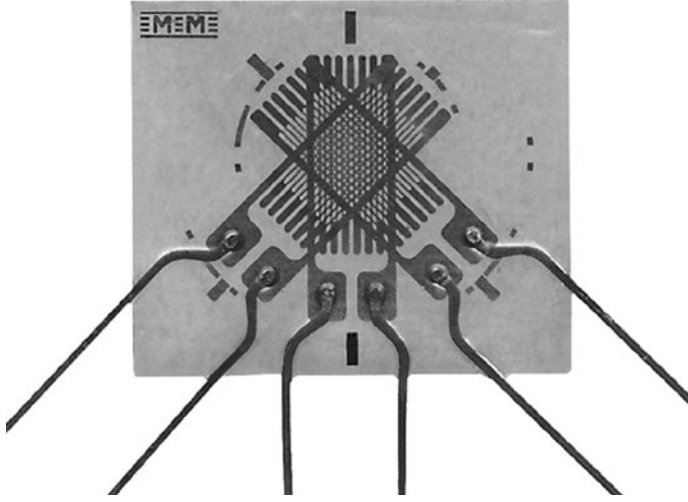
GAGE PATTERN DATA					
 <p style="text-align: center;">actual size</p>			GAGE DESIGNATION See Note 1, 3	RESISTANCE (OHMS) See Note 2	OPTIONS AVAILABLE See Note 3
			WA-XX-120WR-120 WA-XX-120WR-350 WD-DY-120WR-350 WK-XX-120WR-120 WK-XX-120WR-350 SA-XX-120WR-120 SA-XX-120WR-350 SK-XX-120WR-120 SK-XX-120WR-350 SD-DY-120WR-350	120 ± 0.5% 350 ± 0.5% 350 ± 0.5% 120 ± 0.5% 350 ± 0.5% 120 ± 0.5% 350 ± 0.5% 120 ± 0.5% 350 ± 0.5% 350 ± 0.5%	W W W* W W
DESCRIPTION Three-element 45° rectangular stacked rosette					
GAGE DIMENSIONS		Legend ES = Each Section CP = Complete Pattern S = Section (S1 = Section 1) M = Matrix			<input type="checkbox"/> inch <input type="checkbox"/> millimeter
Gage Length	Overall Length	Grid Width	Overall Width	Matrix Length	Matrix Width
0.120 ES	0.34 M	0.080 ES	0.040 M	0.34	0.40
3.05 ES	8.6 M	2.03 ES	10.2 M	8.6	10.2

GAGE SERIES DATA — See Gage Series datasheet for complete specifications			
Series	Description	Strain Range	Temperature Range
WA	Fully encapsulated constantan gages with high-endurance leadwires.	±2%	-100° to +400°F (-75° to +205°)
WD	Fully encapsulated isoelastic gages with high-endurance leadwires.	±1.5%	-320° to +500°F (-195° to +260°C)
WK	Fully encapsulated K-alloy gages with high-endurance leadwires.	±1.5%	-452° to +550°F (-269° to +290°C)
SA	Fully encapsulated constantan gages with solder dots.	±2%	-100° to +400°F (-75° to +205°C)
SK	Fully encapsulated K-alloy gages with solder dots.	±1.5%	-452° to +450°F (-269° to +230°C)
SD	Equivalent to WD Series, but with solder dots instead of leadwires.	±1.5%	-320° to +400°F (-195° to +205°C)



Note 1: Insert desired S-T-C number in spaces marked XX.

Note 2: Tolerance is increased when Option W, E, SE, LE, or P is specified.

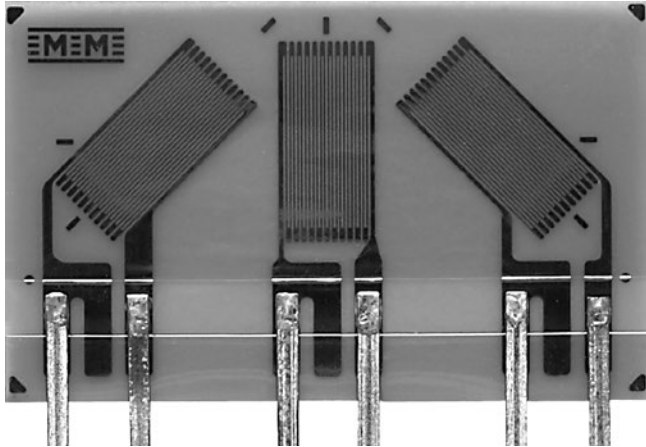
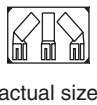

Note 3: Products with designations and options shown in **bold** are not RoHS compliant.

*Options available but not normally recommended. See Optional Features datasheet for details.

General Purpose Strain Gages – Rectangular Rosette



GAGE PATTERN DATA					
			GAGE DESIGNATION See Note 1	RESISTANCE (OHMS)	OPTIONS AVAILABLE
			L2A-XX-125LR-120 L2A-XX-125LR-350 C2A-XX-125LR-120 C2A-XX-125LR-350	120 ± 0.6% 350 ± 0.6% 120 ± 0.6% 350 ± 0.6%	
 <p>actual size</p>			DESCRIPTION General-purpose 45° rectangular single-plane rosette.		
GAGE DIMENSIONS		Legend ES = Each Section S = Section (S1 = Section 1)			inch millimeter
				CP = Complete Pattern	
				M = Matrix	
Gage Length	Overall Length	Grid Width	Overall Width	Matrix Length	Matrix Width
0.125	0.245	0.070	0.415	0.290	0.475
3.18	6.22	1.78	10.54	7.37	12.06

GAGE SERIES DATA — See Gage Series datasheet for complete specifications			
Series	Description	Strain Range	Temperature Range
L2A	Encapsulated constantan gages with preattached ribbon leads.	±3%	-100° to +250°F (-75° to +120°C)
C2A	Encapsulated constantan gages with preattached ready-to-use cables.	±3%	-60° to +180°F (-50° to +80°C)

 <p>Example of an L2A Construction</p>	 <p>Example of an C2A Construction</p>
---	--

Note 1: Insert desired S-T-C number in spaces marked XX.

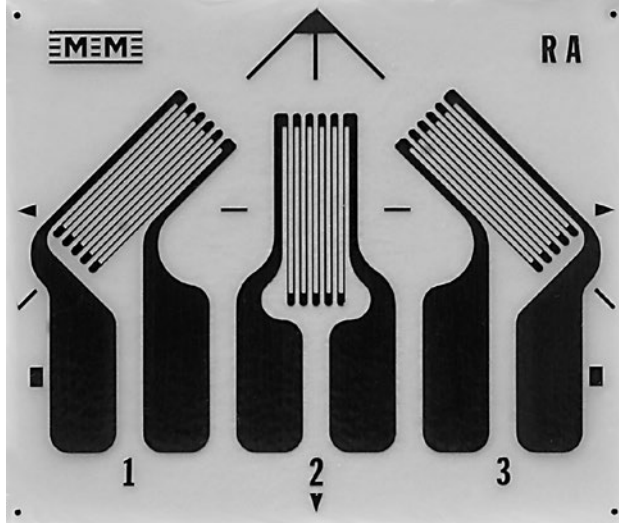
General Purpose Strain Gages – Rectangular Rosette

GAGE PATTERN DATA					
  actual size			GAGE DESIGNATION See Note 1, 3	RESISTANCE (OHMS) See Note 2	OPTIONS AVAILABLE See Note 3
			EA-XX-125RA-120 EK-XX-125RA-350* WA-XX-125RA-120 WK-XX-125RA-350 EP-08-125RA-120 SA-XX-125RA-120 SK-XX-125RA-350	120 ± 0.2% 350 ± 0.2% 120 ± 0.4% 350 ± 0.4% 120 ± 0.2% 120 ± 0.4% 350 ± 0.4%	W, E, L, LE W, SE W** W**
DESCRIPTION General-purpose three-element 45° rectangular rosette. Compact geometry. See also 125RD and 125UR patterns.					
GAGE DIMENSIONS		Legend ES = Each Section CP = Complete Pattern S = Section (S1 = Section 1) M = Matrix			
					inch millimeter
Gage Length	Overall Length	Grid Width	Overall Width	Matrix Length	Matrix Width
0.125 ES	0.275 CP	0.062 ES	0.424 CP	0.39	0.46
3.18 ES	6.99 CP	1.57 ES	10.77 CP	9.9	11.7

GAGE SERIES DATA — See Gage Series datasheet for complete specifications			
Series	Description	Strain Range	Temperature Range
EA	Constantan foil in combination with a tough, flexible, polyimide backing.	±3%	-100° to +350°F (-75° to +175°C)
EK	K-alloy foil in combination with a tough, flexible polyimide backing.	±1.5%	-320° to +350°F (-195° to +175°C)
WA	Fully encapsulated constantan gages with high-endurance leadwires.	±2%	-100° to +400°F (-75° to +205°)
WK	Fully encapsulated K-alloy gages with high-endurance leadwires.	±1.5%	-452° to +550°F (-269° to +290°C)
EP	Annealed constantan foil with tough, high-elongation polyimide backing.	±20%	-100° to +400°F (-75° to +205°C)
SA	Fully encapsulated constantan gages with solder dots.	±2%	-100° to +400°F (-75° to +205°C)
SK	Fully encapsulated K-alloy gages with solder dots.	±1.5%	-452° to +450°F (-269° to +230°C)

Note 1: Insert desired S-T-C number in spaces marked XX.

Note 2: Tolerance is increased when Option W, E, SE, LE, or P is specified.

Note 3: Products with designations and options shown in **bold** are not RoHS compliant.

* EK-Series gages are supplied with duplex copper pads (DP) when optional feature W or SE is not specified.

** Options available but not normally recommended. See Optional Features datasheet for details.

General Purpose Strain Gages – Rectangular Rosette

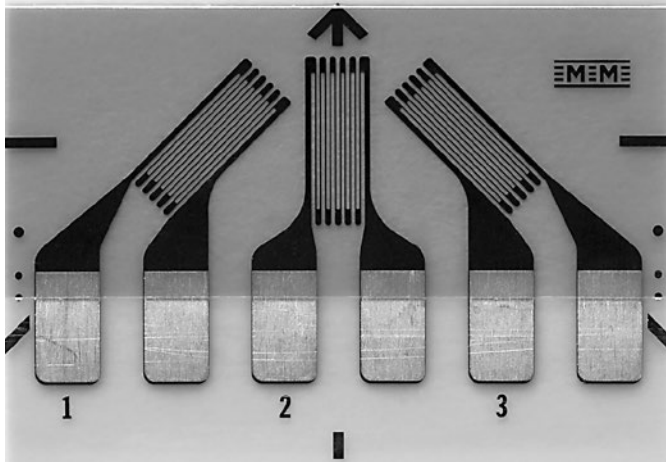
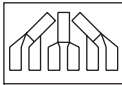

GAGE PATTERN DATA					
			GAGE DESIGNATION See Note 1	RESISTANCE (OHMS)	OPTIONS AVAILABLE See Note 2
			CEA-XX-125UR-120 CEA-XX-125UR-350	120 ± 0.4% 350 ± 0.4%	P2 P2
 <p>actual size</p>			DESCRIPTION General-purpose 45° single-plane rosette. Compact geometry. Exposed solder tab area 0.08 x 0.06 in (2.0 x 1.5 mm).		
GAGE DIMENSIONS		Legend ES = Each Section CP = Complete Pattern S = Section (S1 = Section 1) M = Matrix			<input type="checkbox"/> inch <input type="checkbox"/> millimeter
Gage Length	Overall Length	Grid Width	Overall Width	Matrix Length	Matrix Width
0.125 ES	0.300 CP	0.060 ES	0.560 CP	0.42	0.62
3.18 ES	7.62 CP	1.52 ES	14.22 CP	10.7	15.7

GAGE SERIES DATA — See Gage Series datasheet for complete specifications			
Series	Description	Strain Range	Temperature Range
CEA	Universal general-purpose strain gages.	±5%	-100° to +350°F (-75° to +175°C)

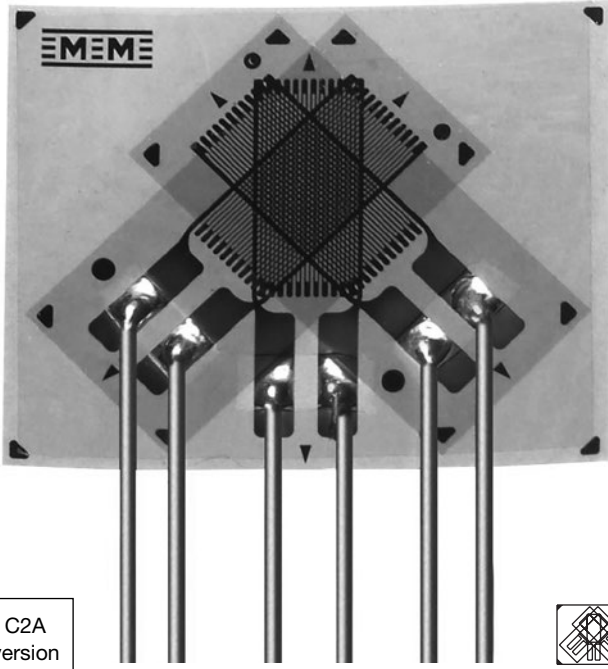

Note 1: Insert desired S-T-C number in spaces marked XX.

Note 2: Products with designations and options shown in bold are not RoHS compliant.

General Purpose Strain Gages—Stacked Rosette

GAGE PATTERN DATA					
 <p>C2A version shown</p> <p>actual size</p>			GAGE DESIGNATION See Note 1	RESISTANCE (OHMS)	OPTIONS AVAILABLE
			L2A-XX-125WW-120 L2A-XX-125WW-350 C2A-XX-125WW-120 C2A-XX-125WW-350	120 ± 0.6% 350 ± 0.6% 120 ± 0.6% 350 ± 0.6%	
DESCRIPTION Stacked, 0°-45°-90° rosette for use in applications involving limited gaging areas or steep strain gradients.					
GAGE DIMENSIONS		Legend ES = Each Section S = Section (S1 = Section 1)			<input type="checkbox"/> inch <input type="checkbox"/> millimeter
				CP = Complete Pattern	
				M = Matrix	
Gage Length	Overall Length	Grid Width	Overall Width	Matrix Length	Matrix Width
0.125 ES	0.241 CP	0.070 ES	0.280 CP	0.309	0.375
3.18 ES	6.12 CP	1.78 ES	7.11 CP	7.85	9.53



GAGE SERIES DATA — See Gage Series datasheet for complete specifications			
Series	Description	Strain Range	Temperature Range
L2A	Encapsulated constantan gages with preattached ribbon leads.	±3%	-100° to +150°F (-75° to +65°C)
C2A	Encapsulated constantan gages with preattached ready-to-use cables.	±3%	-60° to +150°F (-50° to +65°C)

 <p>Example of an L2A Construction</p>	 <p>Example of an C2A Construction</p>
---	--

Note 1: Insert desired S-T-C number in spaces marked XX.

Note 2: Upper use range is reduced to these values for stacked patterns.

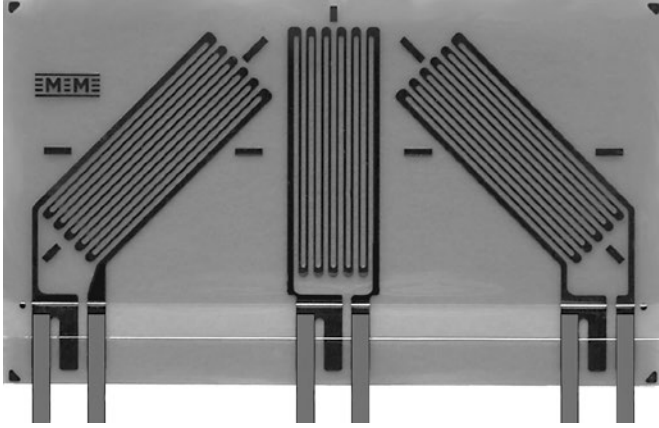
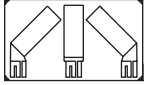
General Purpose Strain Gages – Rectangular Rosette

GAGE PATTERN DATA					
			GAGE DESIGNATION See Note 1	RESISTANCE (OHMS)	OPTIONS AVAILABLE
			L2A-XX-250LR-120 L2A-XX-250LR-350 C2A-XX-250LR-120 C2A-XX-250LR-350	120 ± 0.6% 350 ± 0.6% 120 ± 0.6% 350 ± 0.6%	
 <p>actual size</p>			DESCRIPTION General-purpose 45° rectangular single-plane rosette.		 RoHS COMPLIANT
GAGE DIMENSIONS		Legend ES = Each Section CP = Complete Pattern S = Section (S1 = Section 1) M = Matrix			<input type="checkbox"/> inch <input type="checkbox"/> millimeter
Gage Length	Overall Length	Grid Width	Overall Width	Matrix Length	Matrix Width
0.250	0.373	0.100	0.655	0.420	0.715
6.35	9.47	2.54	16.64	10.67	18.16

GAGE SERIES DATA — See Gage Series datasheet for complete specifications			
Series	Description	Strain Range	Temperature Range
L2A	Encapsulated constantan gages with preattached ribbon leads.	±3%	-100° to +250°F (-75° to +120°C)
C2A	Encapsulated constantan gages with preattached ready-to-use cables.	±3%	-60° to +180°F (-50° to +80°C)



Example of an L2A Construction



Example of a C2A Construction

Note 1: Insert desired S-T-C number in spaces marked XX.

General Purpose Strain Gages – Rectangular Rosette

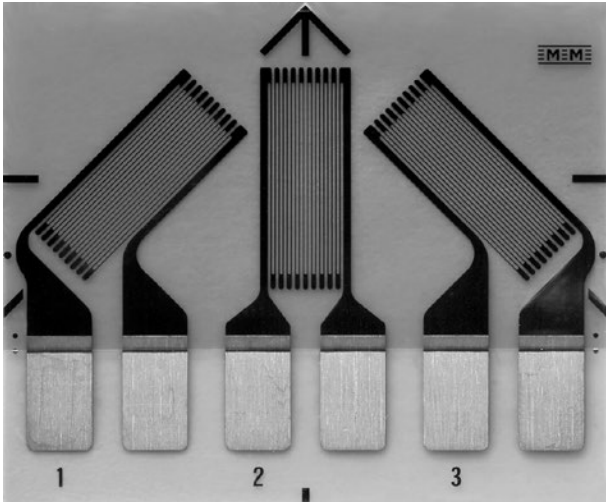
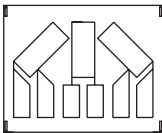
GAGE PATTERN DATA					
			GAGE DESIGNATION See Note 1	RESISTANCE (OHMS)	OPTIONS AVAILABLE See Note 2
			CEA-XX-250UR-120 CEA-XX-250UR-350	120 ± 0.4% 350 ± 0.4%	P2 P2
 <p>actual size</p>			DESCRIPTION Large three-element 45° single-plane rosette. Exposed solder tab area 0.13 x 0.08 in [3.3 x 2.0 mm].		
GAGE DIMENSIONS		Legend ES = Each Section CP = Complete Pattern S = Section (S1 = Section 1) M = Matrix			
	inch				
	millimeter				
Gage Length	Overall Length	Grid Width	Overall Width	Matrix Length	Matrix Width
0.250 ES	0.500 CP	0.120 ES	0.760 CP	0.65	0.80
6.35 ES	12.70 CP	3.05 ES	19.30 CP	16.5	20.3



GAGE SERIES DATA — See Gage Series datasheet for complete specifications

Series	Description	Strain Range	Temperature Range
CEA	Universal general-purpose strain gages.	±5%	-100° to +350°F (-75° to +175°C)

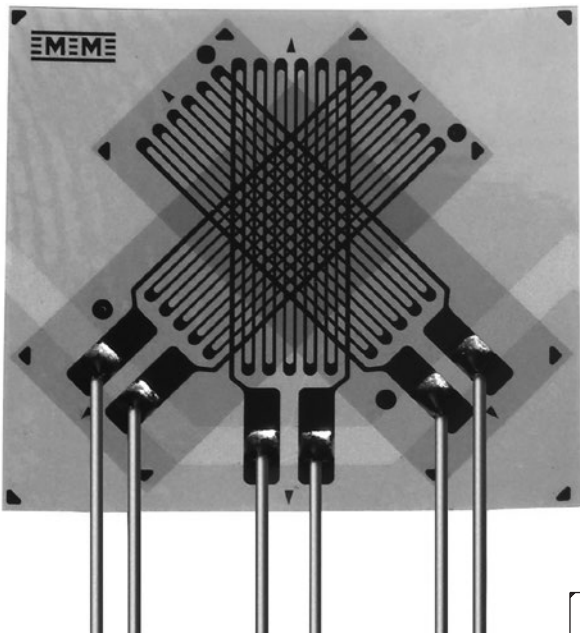

Note 1: Insert desired S-T-C number in spaces marked XX.

Note 2: Products with designations and options shown in bold are not RoHS compliant.

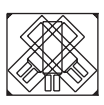
General Purpose Strain Gages—Stacked Rosette

GAGE PATTERN DATA					
		GAGE DESIGNATION See Note 1	RESISTANCE (OHMS)	OPTIONS AVAILABLE	
		L2A-XX-250WW-120 L2A-XX-250WW-350 C2A-XX-250WW-120 C2A-XX-250WW-350	120 ± 0.6% 350 ± 0.6% 120 ± 0.6% 350 ± 0.6%		
		DESCRIPTION Stacked, 0°-45°-90° rosette for use in applications involving limited gaging areas or steep strain gradients.			
		 actual size			
GAGE DIMENSIONS		Legend ES = Each Section S = Section (S1 = Section 1) CP = Complete Pattern M = Matrix			<input type="checkbox"/> inch <input checked="" type="checkbox"/> millimeter
Gage Length	Overall Length	Grid Width	Overall Width	Matrix Length	Matrix Width
0.250 ES	0.362 CP	0.100 ES	0.375 CP	0.418	0.477
6.35 ES	9.19 CP	2.54 ES	9.53 CP	10.62	12.12











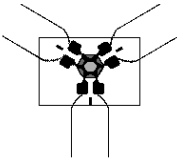

GAGE SERIES DATA — See Gage Series datasheet for complete specifications			
Series	Description	Strain Range	Temperature Range
L2A	Encapsulated constantan gages with preattached ribbon leads.	±3%	-100° to +150°F (-75° to +65°C)
C2A	Encapsulated constantan gages with preattached ready-to-use cables.	±3%	-60° to +150°F (-50° to +65°C)

 Example of an L2A Construction	 Example of an C2A Construction
---	--

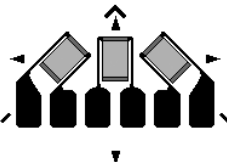
Note 1: Insert desired S-T-C number in spaces marked XX.

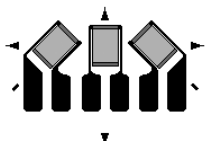
Note 2: Upper use range is reduced to these values for stacked patterns.

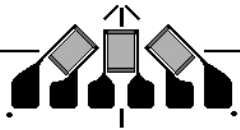







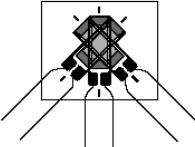

General Purpose Strain Gages

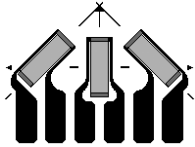
GAGE PATTERN	GAGE SERIES See Note 1	GAGE RESISTANCE (OHMS)	GAGE LENGTH	
			inches	millimeters
015RC   actual size	EA, SA	120	0.015	0.38
	Micro-miniature three-element 45° rosette with one tab common to all sections. See also 015RJ pattern. Note: See Strip Patterns datasheet for discussion of common-tab gages. Matrix size: 0.18L x 0.23W in. (4.6L x 5.8W mm)			
015RJ   actual size	EA, SA	120	0.015	0.38
	Micro-miniature three-element 45° rosette. Similar to 015RC pattern except each section has separate tabs for electrical isolation. Matrix size: 0.19L x 0.23W in. (4.8L x 5.8W mm)			
030WR   actual size	WA, WK, SA, SK	120	0.03	0.76
	Miniature three-element 45° rectangular stacked rosette. Matrix size: 0.18L x 0.19W in. (4.6L x 4.8W mm)			
031RB   actual size	EA, EP, SA	120	0.031	0.79
	Miniature 45° rectangular single-plane rosette with compact geometry. Matrix size: 0.19L x 0.24W in. (4.8L x 6.1W mm)			
062RB   actual size	EA, WA, WK, EP, SA, SK	120, 350	0.062	1.57
	Small 45° rectangular single-plane rosette with compact geometry. Matrix size: 0.42L x 0.46W in. (10.7L x 11.7W mm)			
062RF   actual size	EA, SA	350	0.062	1.57
	Small 45° rectangular single-plane rosette designed for use with Option W. Matrix size: 0.25L x 0.46W in. (6.4L x 11.7W mm)			

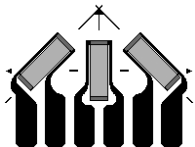
Note 1: Products with designations and options shown in **bold** are not RoHS compliant.

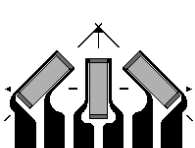
See <http://www.vishaypg.com/micro-measurements/stress-analysis-strain-gages/other-rectangular-rosettes/> for complete specifications.

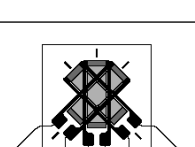
General Purpose Strain Gages

GAGE PATTERN	GAGE SERIES See Note 1	GAGE RESISTANCE (OHMS)	GAGE LENGTH	
			inches	millimeters
120WR   actual size	WA, WD, WK, SA, SK, SD	120, 350	0.12	3.05
Three-element 45° rectangular stacked rosette. Matrix size: 0.34L x 0.40W in. (8.6L x 10.2W mm)				
125RD   actual size	EA, WA, SA	350	0.125	3.18
General-purpose three-element 45° rectangular rosette. Similar to 125RA pattern except for grid resistance. Matrix size: 0.40L x 0.47W in. (10.1L x 11.9W mm)				
250RA   actual size	EA, WA, WK, EP, SA, SK	120, 350	0.25	6.35
Large three-element 45° rectangular rosette with convenient solder tab arrangement. See also 250RD pattern. Matrix size: 0.78L x 0.93W in. (19.8L x 23.6W mm)				
250RD   actual size	EA, EK, S2K, WA, WK, EP, SA, SK	350, 1000	0.25	6.35
Large three-element 45° rectangular rosette. Similar to the 250RA pattern except for resistance. EK-Series gages are supplied with duplex copper pads (DP) when optional feature W or SE is not specified. Matrix size: 0.78L x 0.93W in. (19.8L x 23.6W mm)				
250WR   actual size	WA, WD, WK, SA, SK, SD	120, 350	0.25	6.35
Three-element 45° rectangular stacked rosette. Matrix size: 0.51L x 0.60W in. (13.0L x 15.2W mm)				

Note 1: Products with designations and options shown in **bold** are not RoHS compliant.







See <http://www.vishaypg.com/micro-measurements/stress-analysis-strain-gages/other-rectangular-rosettes/> for complete specifications.

Delta Rosettes (General-Use)

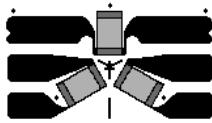
FEATURES

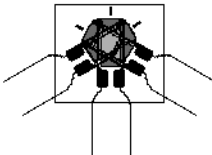
- Gage patterns designed for determining principle stresses and strains
- All patterns have three grids oriented at 0°, 60° and 120° angles
- Both stacked and planar constructions available
- Gage lengths from 0.30" (0.76 mm) to 0.125" (3.18 mm)

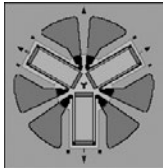
General Purpose Strain Gages

GAGE PATTERN	GAGE SERIES See Note 1	GAGE RESISTANCE (OHMS)	GAGE LENGTH	
			inches	millimeters
030YB   actual size	EA, SA	120	0.03	0.76
	Miniature three-element 60° delta single-plane rosette. Matrix size: 0.21L x 0.27W in. (5.3L x 6.9W mm)			
060WY   actual size	WA, WK, SA, SK	120, 350, 1000	0.06	1.52
	Small three-element 60° delta stacked rosette. Matrix size: 0.24L x 0.30W in. (6.1L x 7.6W mm)			
125UY   actual size	CEA	120, 350	0.125	3.18
	Three-element 60° delta single-plane rosette. Matrix size: 0.50L x 0.44W in. (12.7L x 11.2W mm)			

Note 1: Products with designations and options shown in **bold** are not RoHS compliant.

See <http://www.micro-measurements.com/stress-analysis-strain-gages/delta-rosettes/> for complete specifications.