

High Speed TireScan™ System

Capture & Analyze Tire Behavior at High Speeds

Tekscan's High Speed TireScan™ system captures the impact of speed, motion, and inertial forces on a tire at speeds up to 265 km/h (165 mph). The robust array of pressure sensing elements scans at 20 kHz as the tire rolls across it. The software displays the tire shape and pressure distribution while in motion.

KEY FEATURES & BENEFITS

- Capture tire footprint up to 265 km/h (165 mph)
- Fast testing procedure
- Dynamic recording and playback
- Graphing and data analysis capabilities
- Quickly generate custom reports
- Durable & reusable sensors

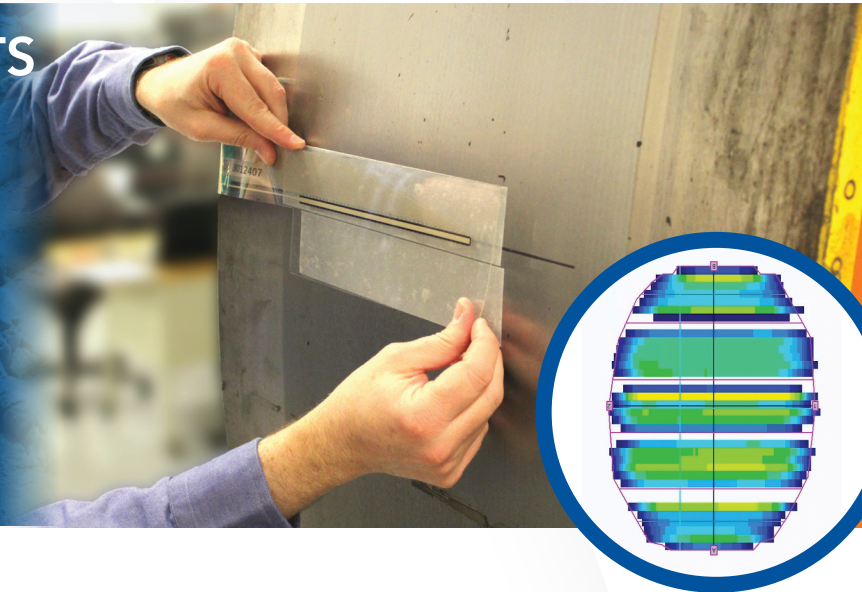

TIRE TYPES

- Passenger
- Bus
- Truck
- Agricultural
- Aircraft
- Racing
- ATV
- Motorcycle

APPLICATIONS

- Evaluate tire performance at high speeds
- Identify failure modes
- Measure tire distortion from inertial forces
- Evaluate cornering performance

Model Specifications

Model #	Hardware	# of Handles	Sensor	Scan Rate	Sensing Width mm (in)	Sensing Element Pitch - mm (in)
THSVB9505	Tethered	1	9505	20 kHz	199.9 (7.87)	223.5 mm (8.80") 4.6 (0.18)
THSVD9505	Datalogger	1	9505	20 kHz	199.9 (7.87)	
THSRV9505	Remote VersaTek	1	9505	20 kHz	199.9 (7.87)	
THSVB9506	Tethered	2	9506	20 kHz	401.1 (15.79)	
THSVD9506	Datalogger	2	9506	17 kHz	401.1 (15.79)	
THSRV9506	Remote VersaTek	2	9506	20 kHz	401.1 (15.79)	
THSVBR9506-2	Rugged Tethered	4 in 2 metal clamshell	9506	20 kHz	401.1 (15.79) (each sensor)	

High Speed TireScan has 3 configurations: Tethered, Datalogger, and Remote VersaTek (see page 2 for more details).



TWO SYSTEM HARDWARE OPTIONS

Tethered

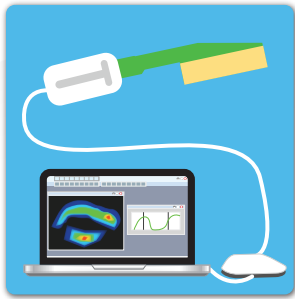

- Sensor
- Scanning electronics
- 8-port VersaTek™ Hub
- TireScan software

Datalogger or Remote VersaTek



- Sensor
- Scanning electronics
- Wireless datalogger or Remote VersaTek unit
- TireScan software

Methods to Capture Data

Method to Capture Data

1 Rotating Drum with Slip Ring

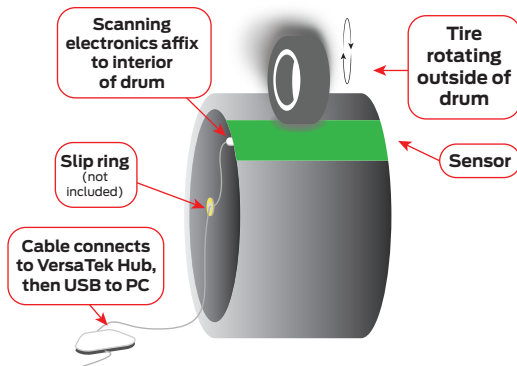

1 Rotating Drum with Datalogger or Remote VersaTek Attached

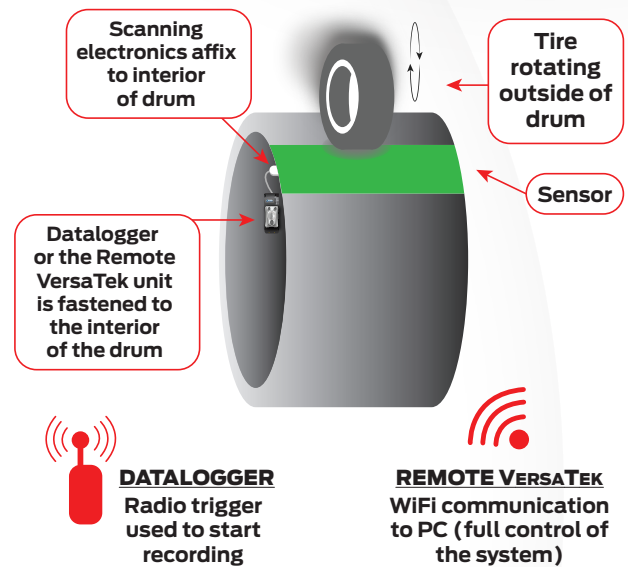

2 Single or Dual Sensors on a Roadway

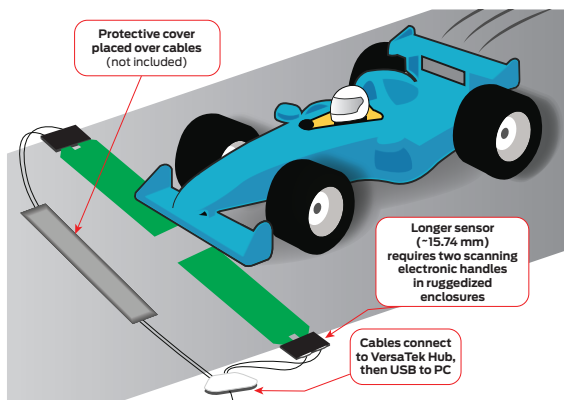

The Differences Between Datalogger and Remote VersaTek

Datalogger: Isolated data collection system; saves data to a USB that can be uploaded after the test is completed.

Remote VersaTek: A Micro PC in the hub collects data locally, maintaining Tekscan's fastest testing speeds. This allows the user to get real-time feedback and control via wireless connection.

HOW HIGH SPEED TIRES CAN WORK

As shown in the drum test illustration below, High Speed TireScan system captures multiple linear arrays across the width of the tire as it rolls across a single-sensing column.

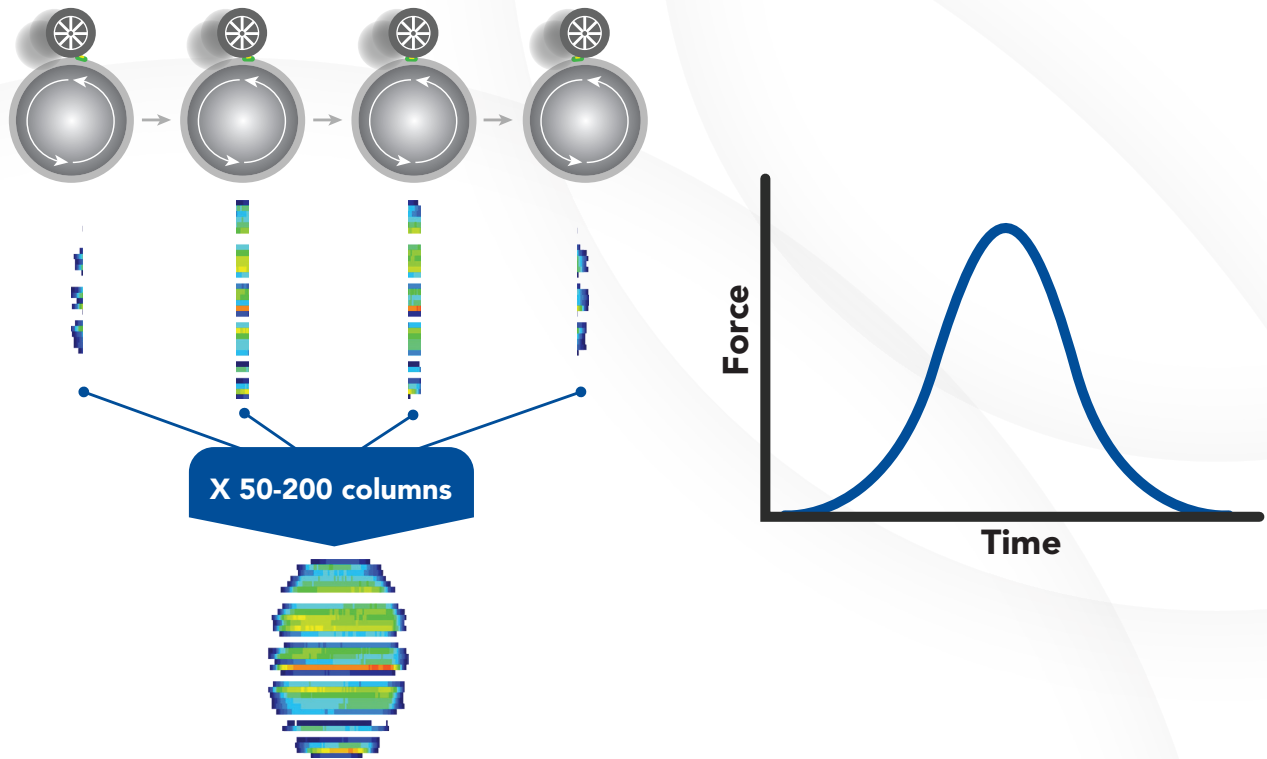

KEY INSIGHTS FROM HIGH SPEED ANALYSIS

High Speed TireScan captures key tire shape changes that can occur from centrifugal forces at different speeds. This example shows how one tire design was affected when tested at 48 km/h (30 mph), and again at 161 km/h (100 mph).

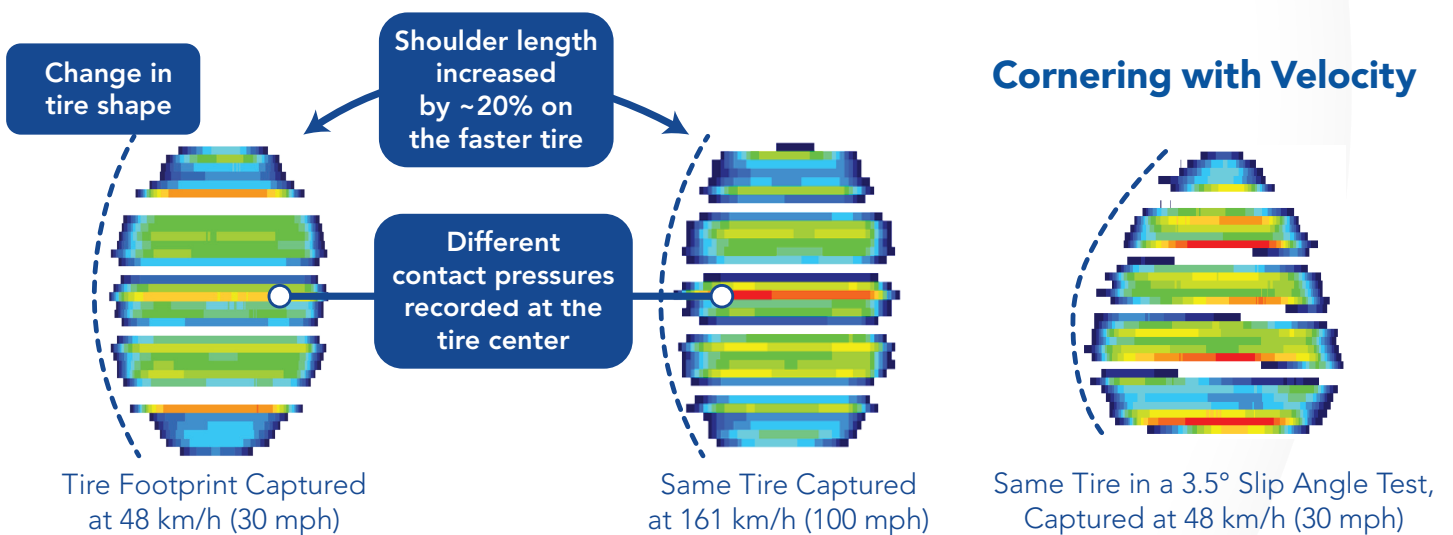

The robust High Speed TireScan sensor can withstand aggressive forces of slip angle tests without a protective cover.

SOFTWARE ANALYSIS

Database

- Organize tire models & tests
- New tests can have basic information of tire automatically populated

Keep a database of internal and competitive tire models

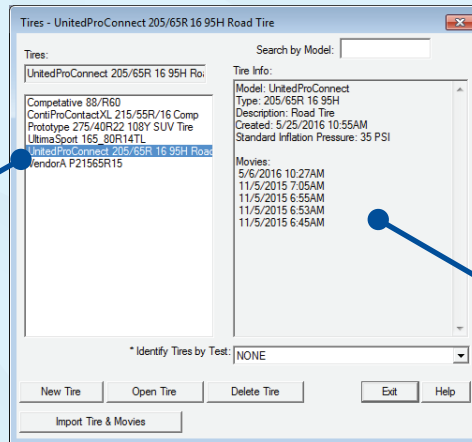

See basic information and all data collected for that model

Tire Geometry Recognition

- Software finds area, center lines, shoulders, etc.
- Calculate key metrics of the tire footprint

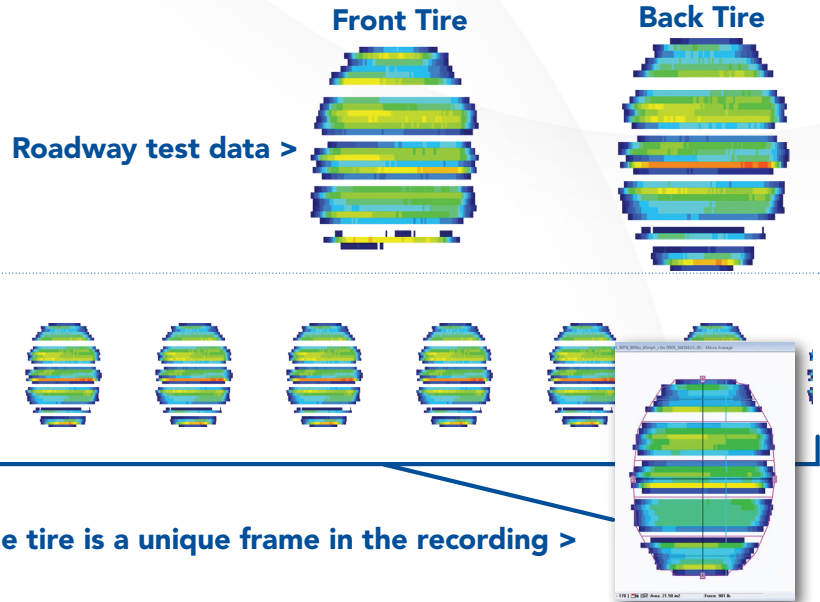

Generate & Export Reports in Multiple User-Friendly File Formats

Data automatically populated into a .Doc file

UnitedProConnect 205/65R 16 95H		
Telescan Description: Road Tire Test: Static Test [P] Inflation: 35 PSI		Sensor: 8540_ofR25 Sensitivity: Custom Page 1 of 3 Created: 5/6/2016 10:27AM Printed: 11/16/2016 2:57PM
Movie = UPC_35_4500_S0_Frame.fx Frame = 1		
Test By:	John Simmons	
Note:	New Tire	
Comments:		
Rim:	5763476	
Batch Number:	29846x33	
[pP] Perimeter Pressure = 38 raw	[cP] Contact Pressure = 58 raw	[F] Force = 591515 raw sum
[pA] Perimeter Area = 158.98 cm ²	[cA] Contact Area = 106.02 cm ²	Contact Ratio = 66.7 %
[L] Length = 11.2 cm	[W] Width = 16.4 cm	L/W = 68 %
[sA] Shoulder = 8.7 cm	[sB] Shoulder = 9.1 cm	
[mL] Max Length = 11.4 cm	[mW] Max Width = 16.5 cm	
Left Half Force: hAF/F*100 = 52.4837 %		
Shoulder Left Ratio: sA/mL = 0.76252		
[h1*] Force = 295212 raw sum	C. Area = 53.13 cm ²	C. Pressure = 57 raw
[h2*] Force = 296303 raw sum	C. Area = 52.89 cm ²	C. Pressure = 58 raw
[hA*] Force = 310449 raw sum	C. Area = 53.62 cm ²	C. Pressure = 60 raw
[hB*] Force = 281066 raw sum	C. Area = 52.41 cm ²	C. Pressure = 55 raw
[q1A*] Force = 156009 raw sum	C. Area = 27.05 cm ²	C. Pressure = 60 raw
[q1B*] Force = 139203 raw sum	C. Area = 26.09 cm ²	C. Pressure = 55 raw
[q2A*] Force = 154440 raw sum	C. Area = 26.57 cm ²	C. Pressure = 60 raw
[q2B*] Force = 141863 raw sum	C. Area = 26.32 cm ²	C. Pressure = 56 raw
From A to B		
[r1*] Force = 117294 raw sum	C. Area = 19.03 cm ²	C. Pressure = 64 raw
[r2*] Force = 113236 raw sum	C. Area = 20.73 cm ²	C. Pressure = 56 raw
[r3*] Force = 137183 raw sum	C. Area = 24.74 cm ²	C. Pressure = 57 raw
[r4*] Force = 111363 raw sum	C. Area = 20.88 cm ²	C. Pressure = 55 raw
[r5*] Force = 112439 raw sum	C. Area = 20.63 cm ²	C. Pressure = 56 raw

TEKSCAN DATA ACQUISITION ELECTRONICS

Tethered Hardware

Drum Tests: VersaTek Handle Dimensions (mm [in.])

Top View

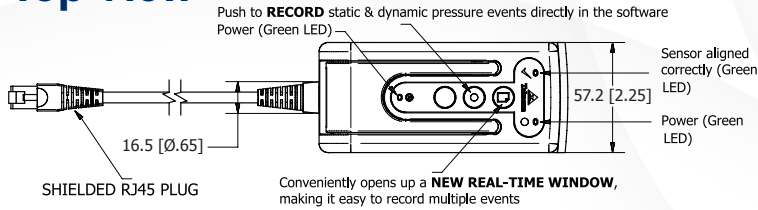

Side View

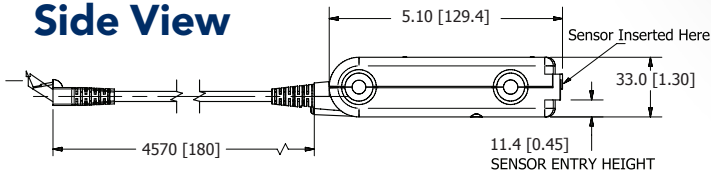

Bottom View

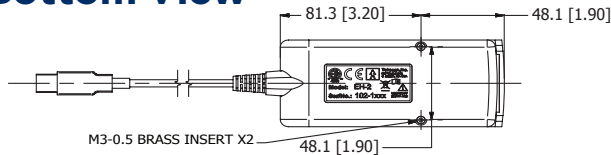

Roadway Tests: VersaTek Ruggedized Handle (VR2)

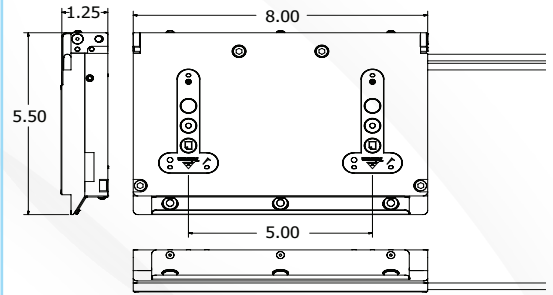

8-port VersaTek Hub Unit Dimensions (mm [in.])

Top View

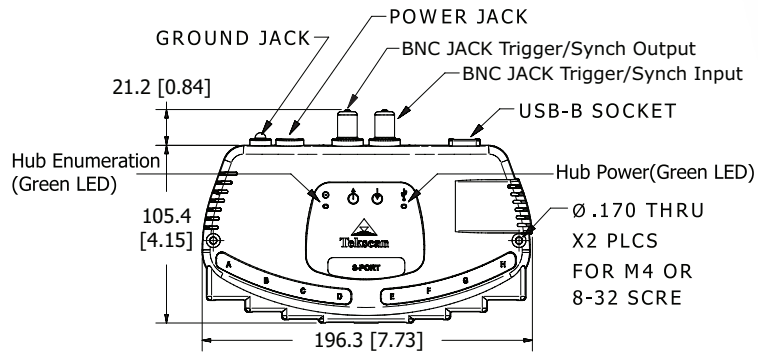

Side View

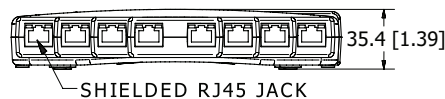

Data Acquisition Electronics Specifications

Housing Material	Handle: Polycarbonate/ABS blend (Grey) Hub: Polyurethane [PUR] (Grey) Ruggedized Handle: Anodized Aluminum (Viton Seal)
Weight	Handle: 305 g (10.8 oz) Hub: 370 g (13.1 oz)
Power Source	Input: 100-240V 5A 50-60 Hz, 1.2A Output: 12V, 5A
Cable Length	Handle to Hub: 4.57 m (15 ft) standard (Up to 30.48 m (100 ft) available) Hub to PC: 3 m (10 ft) standard (Up to 5 m (16.4 ft) available)
Communication to PC	USB 2.0, 480 Mbps

TEKSCAN DATA ACQUISITION ELECTRONICS

Datalogger Hardware (For Drum Testing Only)

VersaTek Handle Dimensions (mm [in.])

Top View

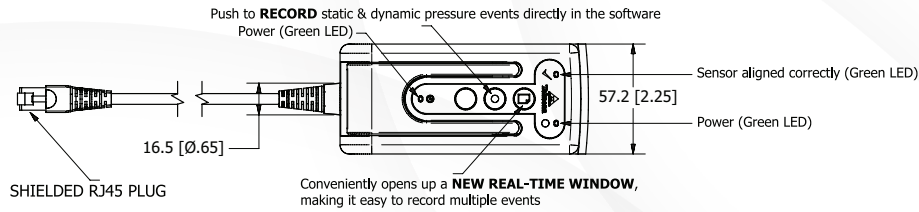

Side View

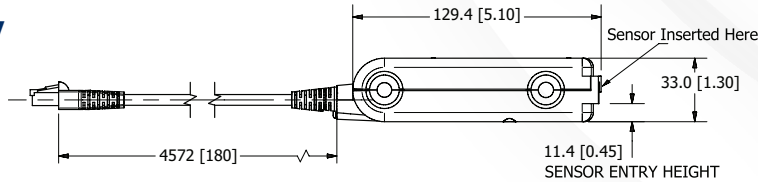

Bottom View

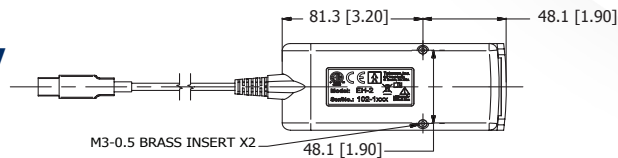

Datalogger Unit Dimensions (mm [in.])

Top View

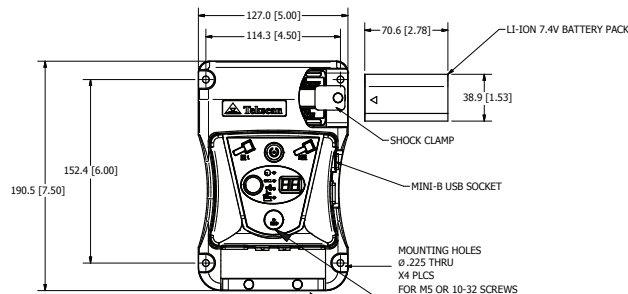

Side View

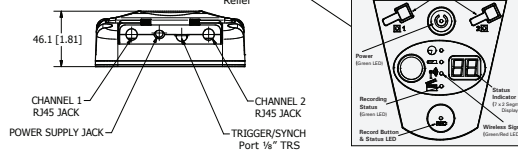

Data Acquisition Electronics Specifications

Housing Material

Handle: Polycarbonate/ABS blend (Grey)
Datalogger Unit: Polycarbonate/ABS blend (Grey)
Datalogger Unit Mounting Fixture: Polyurethane [PUR] (Black)

Weight

Handle: 305 g (10.8 oz) Datalogger Unit: 665 g (24 oz)

Power Source

Li-Ion Battery: 8V / 2.4 Ah or Power supply: 100-240V, 5A

Cable Length

Handle to Datalogger Unit: 4.57 m (15 ft) standard
(Up to 30 m (100 ft) available)

Communication to PC

8 GB Micro SD card (directly or through USB 2.0 cable
connected to Datalogger unit)

TEKSCAN DATA ACQUISITION ELECTRONICS

Remote VersaTek (For Drum Testing Only)

VersaTek Handle Dimensions (mm [in.])

Top View

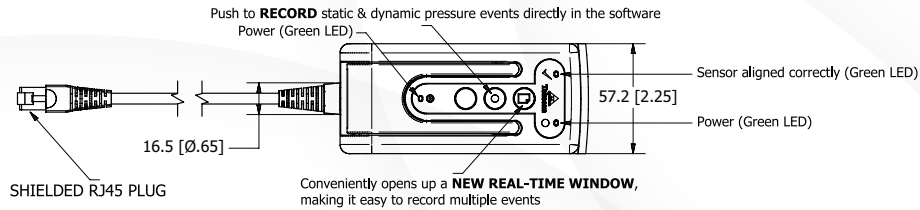

Side View

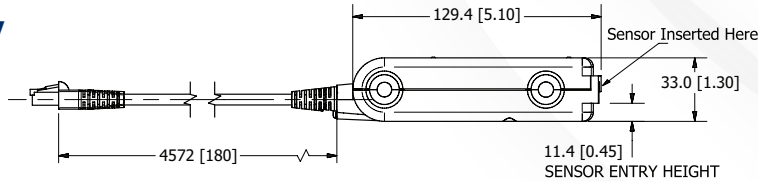

Bottom View

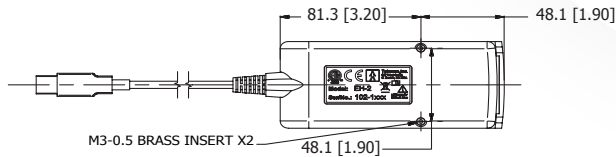

Remote VersaTek Unit Dimensions (mm [in.])

Top View

Side View

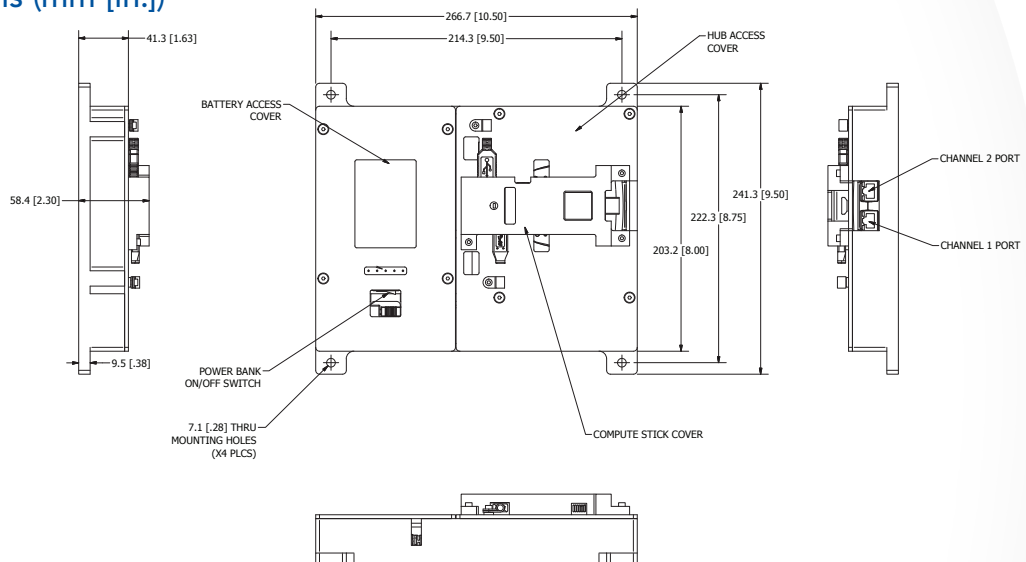

Data Acquisition Electronics Specifications

Housing Material	Handle: Polycarbonate/ABS blend (Grey) Remote VersaTek Unit Base: Nylon (Black) Remote VersaTek Unit Battery Access Cover: Delrin (Black)
Weight	Handle: 305 g (10.8 oz) Remote VersaTek Unit: 1,723 g (60.8 oz)
Power Source	Talent Cell Power Bank (YB1206000-USB) 12V & 5V Output
Cable Length	Handle to Remote VersaTek Unit: 4.57 m (15 ft) standard (Up to 30 m (100 ft) available)
Communication to PC	802.11 wireless (data collected locally, and can be wirelessly uploaded from the Micro PC hub)

9505 SENSOR CONFIGURATION

General Sensor Specifications

Sensor Technology	Resistive
Accuracy	± 5%
Pressure Range	0-4,100 kPa (0-600 psi)
Thickness	0.2 mm (0.008 in.) Not compressible

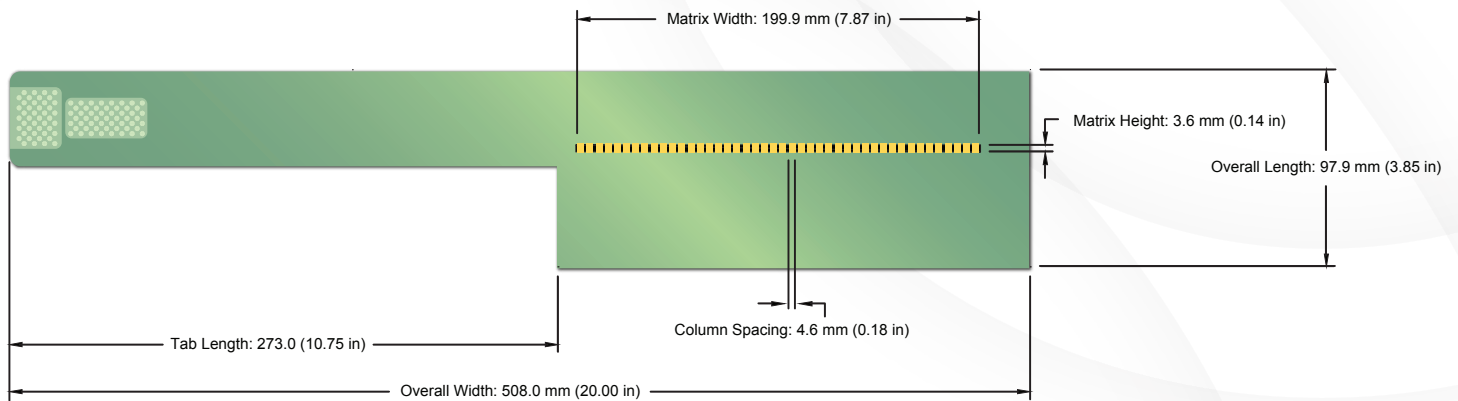

9506 SENSOR CONFIGURATION

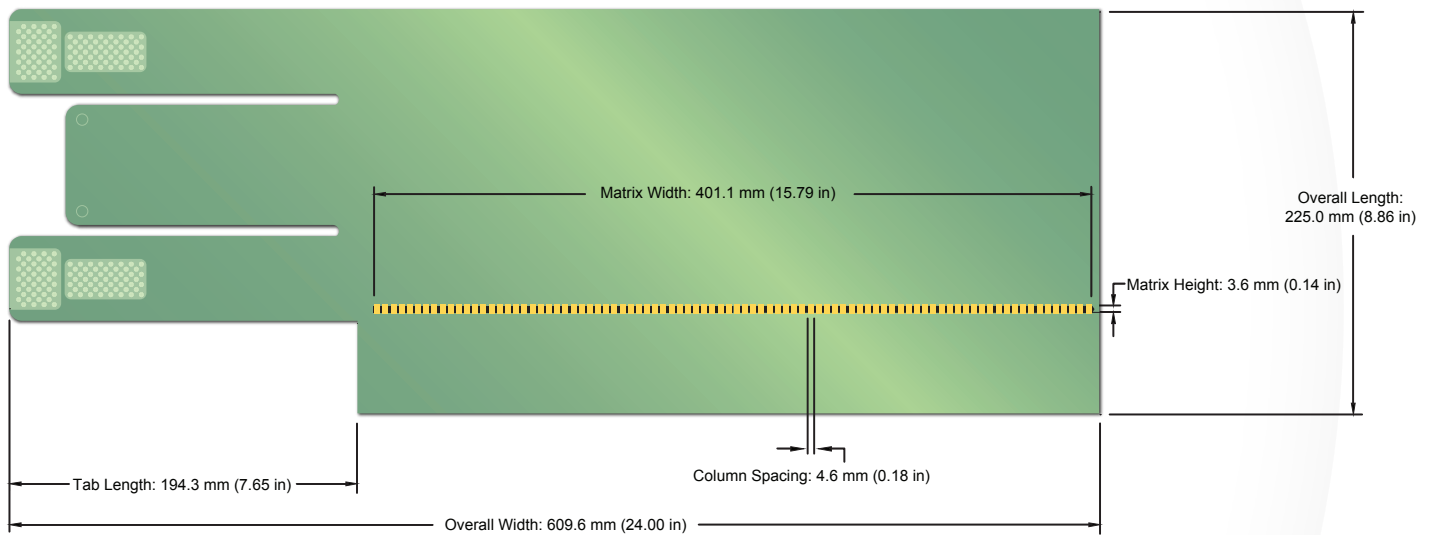

 **CONTACT US | FREE DEMONSTRATION**

+1.617.464.4282

| 1.800.248.3669

| info@tekscan.com

| www.tekscan.com/pm