

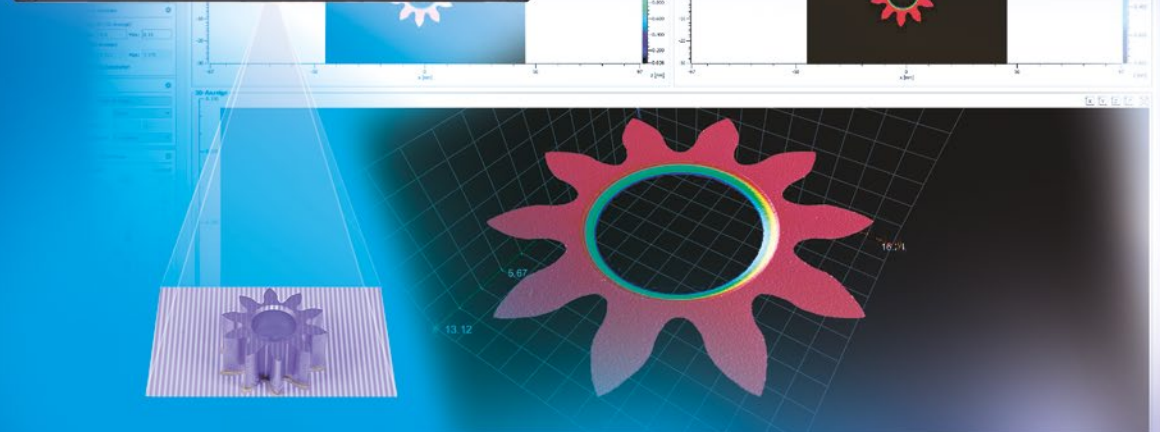

More Precision

surfaceCONTROL 3D 3500 // 3D sensor for geometry, shape and surface inspections





Highest repeatability up to $0.4 \mu\text{m}$

Best z-resolution from $1.0 \mu\text{m}$

Automated inline 3D measurement for geometry, shape and surface inspections

Up to 2.2 million 3D points / second

Fully integrated industrial sensor (IP67) with passive cooling

3D data directly from the sensor

Easy integration in all common 3D image processing packets

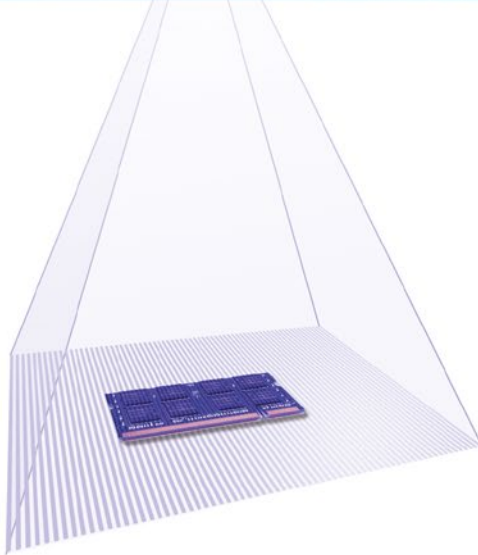

The new generation of high-precision inline 3D measurements

The high-precision surfaceCONTROL 3D 3500 is a 3D snapshot sensor which is ideally suited to automated inline inspection of geometry, shapes and surfaces on diffuse reflecting surfaces. The sensor works according to the principle of fringe projection, which allows direct 3D measurement of components. The surfaceCONTROL 3D 3500 stands out due to its compact design and high measurement accuracy combined with high data processing speed. Two models cover different measuring fields. With a z-repeatability up to $0.4 \mu\text{m}$, the sensor sets a new benchmark in the high precision 3D measurement technology. This is how even the slightest of planarity deviations and height differences can be reliably detected.

In addition to the fast data output via Gigabit Ethernet, the sensor offers an additional digital I/O interface. The 2D/3D gateway offers EtherNet/IP, PROFINET and EtherCAT connections. Powerful software tools enable precise 3D measurements and surface inspection. GigE Vision compatibility also allows easy integration into third-party image processing software. The comprehensive SDK for customer software integration rounds off the software package.

GigE[®]
VISION

C/C++

Microsoft
.NET

Software integration via Micro-Epsilon's SDK

The surfaceCONTROL sensors are equipped with an easy-to-integrate SDK (Software Development Kit). The SDK is based on the GigE Vision and GenICam industry standards including the following function blocks:

- Network configuration and sensor connection
- Comprehensive sensor control
- Control of measurement data transfer (3D data, video images, ...)
- Management of user-defined parameter sets
- C/ C++/ C# library, example programs and documentation

Accessing the sensor via GigE Vision is also possible without SDK if you have a GenICam-compliant software from a third party.

3D Geometry inspection and shape detection

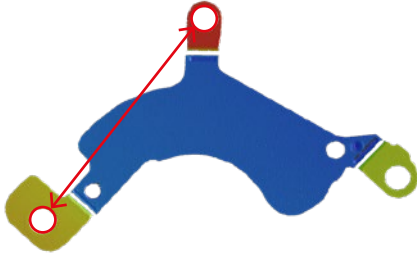

3D measurement of high precision mechanical parts: distance between the holes, planarity and coplanarity of mounting surfaces

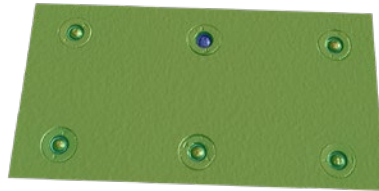

Rivet inspection: Width/tilt angle and width/position of rivet

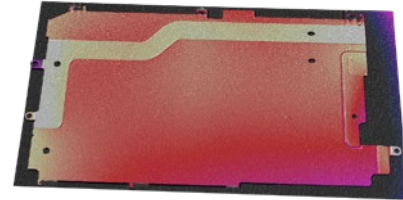

Flatness inspection of high-precision middle boards of smartphone carrier plates

Inspection of electronic components

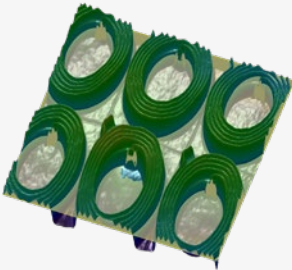

Planarity inspection of unpopulated PCB substrates

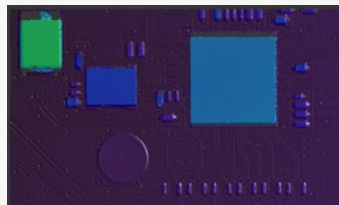

Completeness check of electronic components on fitted PCBs



Monitoring of distance and plane-parallelism of assembled elements to each other and to the base surface (e.g. tombstone effect)

Defect detection

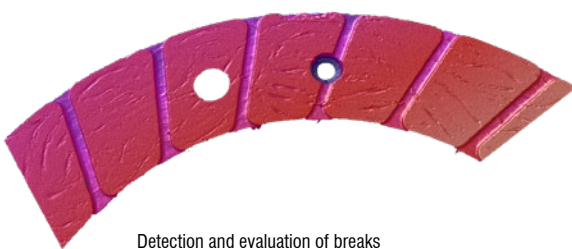

Detection and evaluation of breaks on clutch discs

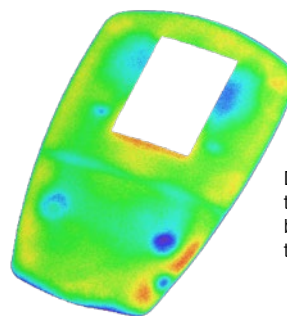

Determination of shape deviation defects on the front side of injection-molded parts caused by injection of bridges and joining elements on the rear side

3D Text recognition and detection of finest structures



3D text recognition of embossments which cannot be solved with 2D image processing due to lack of contrast



Detection of finest structures on small components

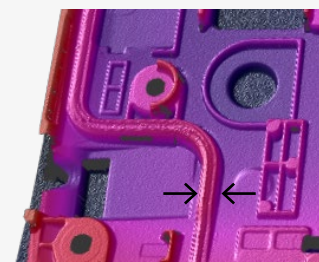

Inspection of height and thickness of adhesive beading on smartphone shells

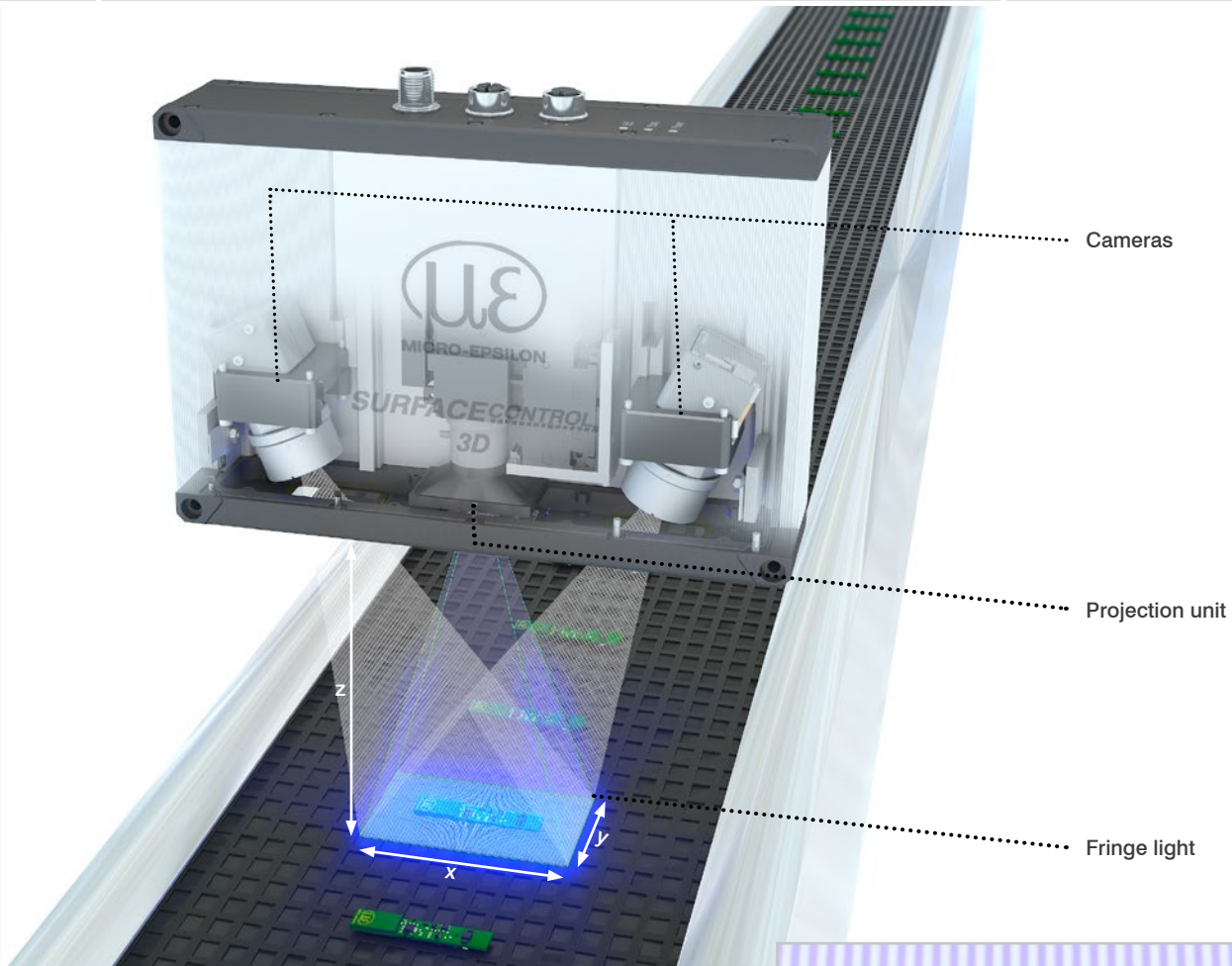

Measuring principle

The surfaceCONTROL 3D 3500 works according to the principle of optical triangulation based on fringe projection. Using a matrix projector, a sequence of patterns is projected onto the test object surface. The light of the patterns diffusely reflected by the test object surface is recorded by two cameras. The three-dimensional surface of the test object is then calculated from the recorded image sequence and the knowledge of the arrangement of the two cameras to each other.

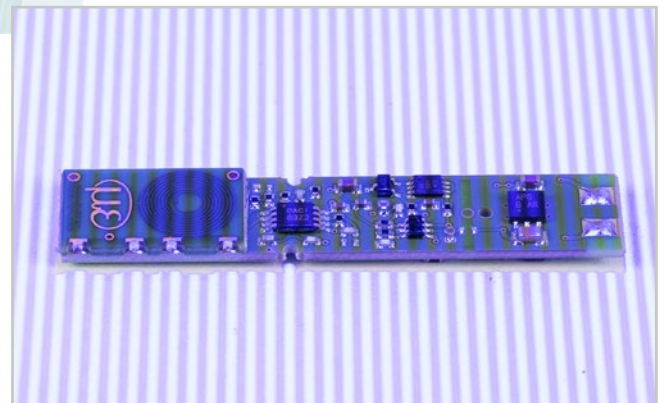

Measuring object with fringe light

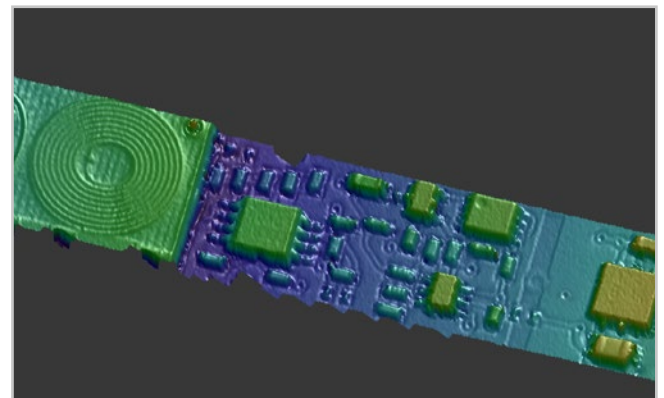

Detailed 3D display due to extremely high Z-resolution

Model	surfaceCONTROL	SC3500-80	SC3510-80	SC3500-120	SC3510-120
Measurement area Length (x) * width (y) at distance (z)	Start expanded area	55 mm x 42 mm at 110 mm		87.5 mm x 62.5 mm at 171 mm	
	Start	67.5 mm x 46 mm at 120 mm		107.5 mm x 70 mm at 191 mm	
	Mid	80 mm x 50 mm at 130 mm		120 mm x 75 mm at 206 mm	
	End	77.5 mm x 52 mm at 140 mm		123.5 mm x 80 mm at 221 mm	
	End expanded area	75 mm x 54 mm at 150 mm		122 mm x 82.5 mm at 241 mm	
Working distance	z	130 ± 10 mm		206 ± 15 mm	
	extended z	130 ± 20 mm		206 ± 35 mm	
Resolution	x, y	40 µm		60 µm	
	z ¹⁾	1.0 µm		2.0 µm	
Repeatability	z (σ) ¹⁾	< 0.4 µm		< 0.8 µm	
Acquisition time ^{2) 3)}		0.2 ... 0.4 s			
Light source		LED			
Supply voltage		18 ... 30 VDC			
Max. current consumption		0.5 ... 2.5 A			
Digital interfaces		Gigabit Ethernet (GigE Vision / GenICam) / PROFINET ⁴⁾ / EtherCAT ⁴⁾ / EtherNet/IP ⁴⁾			
Digital in-/outputs		4 digital I/Os for which parameters can be set (for external trigger, sensor control, output of sensor states)			
Connection		8-pin M12 socket for Gigabit Ethernet, 12-pin M12 socket for digital I/Os, 4-pin M12 plug for power supply			
Mounting		3 mounting holes (installation can be reproduced with centering sleeves)			
Temperature range	Storage	-20 ... 70 °C			
	Operation ⁵⁾	0 ... 45 °C			
Shock (DIN EN 60068-2-27)		15 g / 6 ms in XY axis, 1000 shocks each			
Vibration (DIN EN 60068-2-6)		2 g / 20 ... 500 Hz in XY axis, 10 cycles each			
Protection class (DIN EN 60529)		IP67			
Material		Aluminum housing, passive cooling; external cooling optionally available (see accessories)			
Weight		1.9 kg			
Control and display elements		3 LEDs (for device status, power, data transmission)			
Sensor SDK		Micro-Epsilon 3D-Sensor-SDK			
3D software		Micro-Epsilon 3DInspect			
Functional extension		-	3DInspect Automation	-	3DInspect Automation

¹⁾ Measured on measuring object with cooperative surface in the mid of the measuring range while the "EnhancedSNR" parameter is enabled and a 3x3 mean value filter is used once at a consistent room temperature of 20 ± 1 °C.
²⁾ Duration that the sensor requires for the image acquisition of the pattern projections (without processing and evaluation time).
³⁾ Applies for exposure times < 6,800 µs
⁴⁾ Connection via 2D/3D gateway interface module
⁵⁾ Max. permissible operating temperature depends on installation scenario, thermal connection and operating mode.
 If necessary, external heat dissipation must be used to ensure that the sensor's internal temperature of 60 °C is not exceeded.

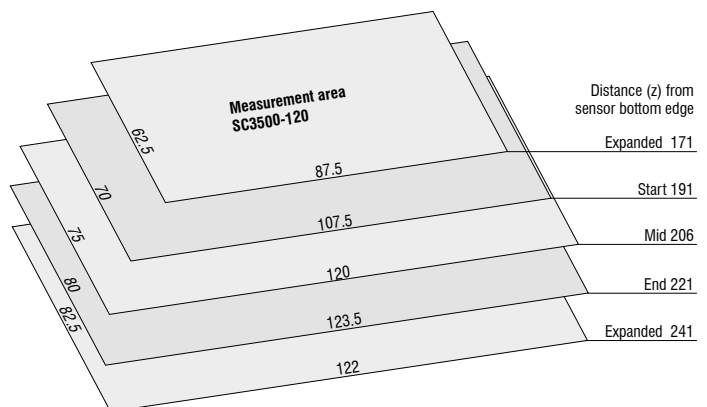
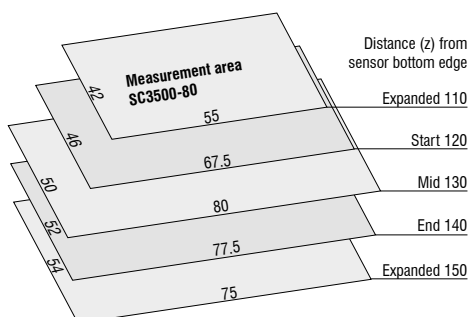
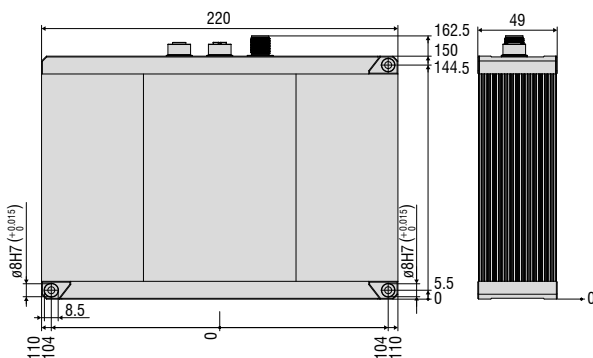

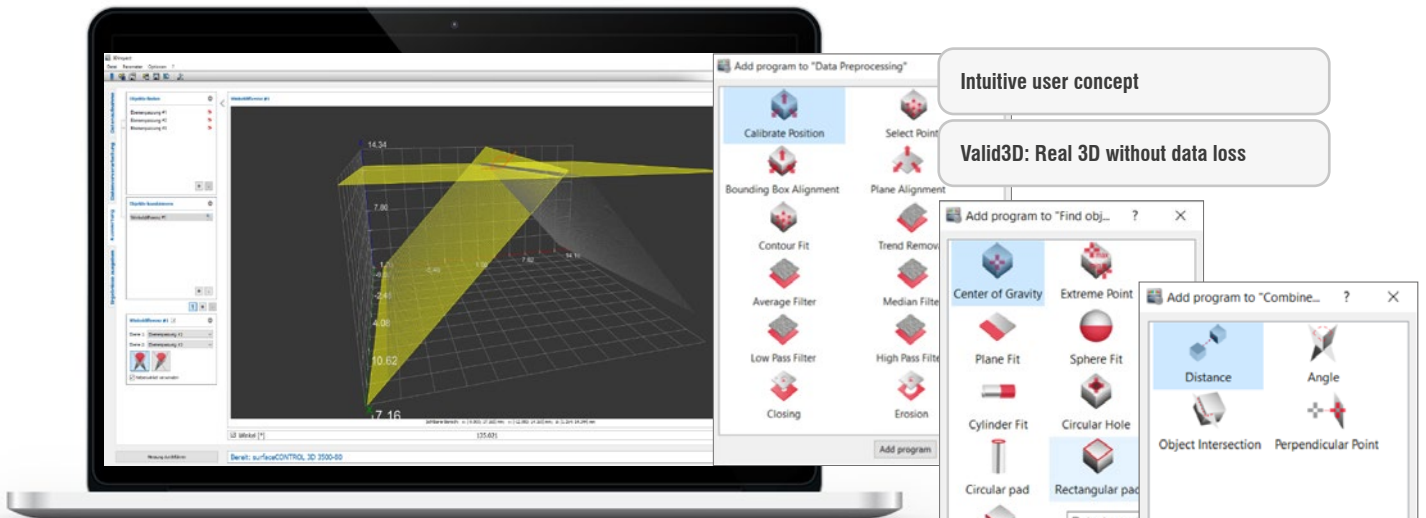

3DInspect software for 3D measurement tasks and inspection

The 3DInspect software is a powerful tool for sensor parameter set up and industrial measurement tasks. This software transmits the measurement data from the sensor via Ethernet and provides the data in three-dimensional form. This 3D data is further processed, evaluated and assessed with 3DInspect measuring programs on the PC and, if necessary, logged and transmitted via Ethernet to a control unit. Furthermore, the software enables the storage of 3D data. The 3DInspect software is included in the scope of delivery. For connection to an automation interface, the functional extension 3DInspect Automation is enabled with use of the SC5310 sensors, which also includes comprehensive data logging.

Intuitive user concept

Valid3D: Real 3D without data loss

The pre-defined measuring software programs can be divided into the categories "Data preprocessing", "Find objects" as well as in "Combine objects".

Valid3D - Real 3D without data loss

Measuring object

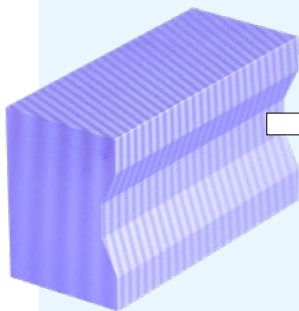

Point cloud

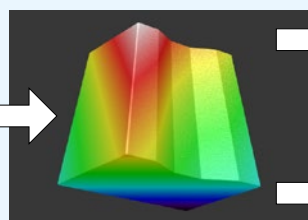

Point cloud after turn

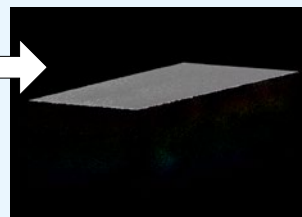
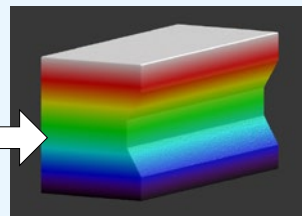

3DInspect with Valid3D

- Real 3D image of test object without data loss
- Analysis and evaluation of complete test object

Common 3D software

- Algorithms based on 2.5D
- Only one Z-coordinate per x/y coordinate possible
- Data loss during data processing

3D View software for 3D visualization

The 3D View software offers a convenient user interface for surfaceCONTROL sensors. This user-friendly software enables quick commissioning and evaluation of the sensor. It offers set up and optimization of parameters and ensures the correct positioning of the measuring object and sensor. The software can also be used to start data acquisition. It visualizes the 3D data obtained and exports it in different file formats (ASCII, CSV, STL, PLY) for further processing.

The 3D View software is particularly helpful for system integrators as it provides important information. They can access all GenICam parameters, which considerably simplifies the integration of the software. For inline applications, the display of the measurement duration allows conclusions to be drawn about the cycle time.

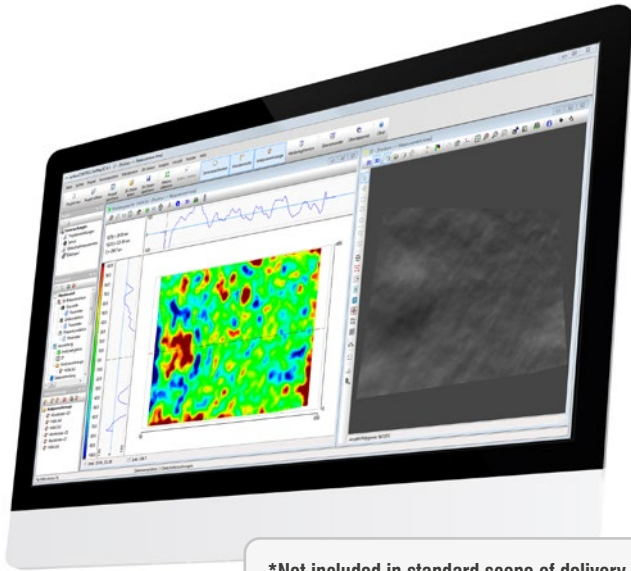

***Not included in standard scope of delivery**

surfaceCONTROL DefMap3D for individual surface analysis*

surfaceCONTROL DefMap3D is a comprehensive software solution for the detection and analysis of surface defects. It includes all components and processes required for set up, configuration and evaluation of inspection tasks.

The wide range of features equally supports the analysis of individual parts, the measurement of small series as well as the robot-supported inspection of several measuring fields. Sensor control, calculation of the 3D point cloud and defect detection can be automated using macro commands.

As part of the surface analysis, the software provides several methods of detecting and objectively evaluating shape errors within the surface data. The targeted use of different filter types can reduce the effects of surface structures (e.g. graining). A report containing the inspection results is generated. surfaceCONTROL DefMap3D is available in different versions whose scope of performance is oriented towards different measurement tasks.

Digital shape

The 3D data of the surface is described using polynomials. Depending on their degree, the polynomials have the ability to adapt the shape of the surface like an envelope. The 3D data is compared against the calculated envelope and possible deviations in the surface are identified as defects.

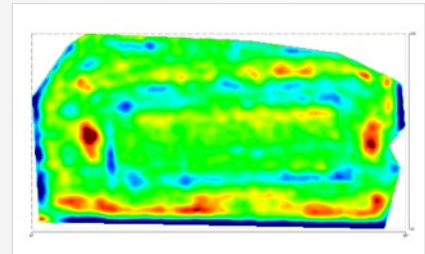

Digital stone

With the 3D data, you can determine the two highest points (point of support) along a line segment in a given direction. Afterwards the gaps between this line and the 3D data are calculated.

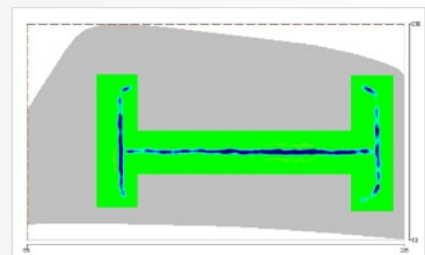

Digital light tunnel

The captured 3D data is given defined properties (color, gloss) and optionally reflected on the screen with a diffuse light or a light bar. This is how even the smallest defects become visible and can be assessed visually.



Innovative 3D Technologies from Micro-Epsilon

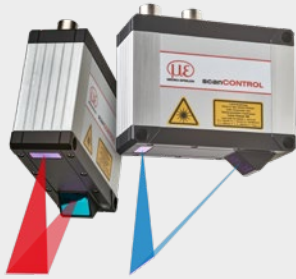

scanCONTROL

- Precise laser line scanners for 3D point clouds
- Red laser & patented Blue Laser Technology
- Up to 2048 points per profile
- Measuring rates up to 10,000 kHz
- Real-time surface compensation

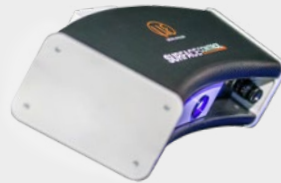

surfaceCONTROL 2500

- Inspection of matt surfaces with high accuracy
- Large measuring fields up to 575 x 435 x 300 mm³
- Detection of different surface form defects
- Objective evaluation of the deviations
- Continuous process monitoring
- Optical error marking with back projection



reflectCONTROL Sensor

- Measurement of shiny, flat components
- Fast, full-surface inspection
- High-precision measurements, flatness deviation in the submicron range
- Large measuring field