

BeanDevice® 2.4GHz AN-mV

Wireless IIOT Data Acquisition (DAQ) | low voltage inputs ($\pm 20\text{mV}$) for load cell sensors

PRODUCT VIDEO



USER GUIDE



QUICK START



MECHANICAL DRAWING



STEP FILE



ProcessSensor



MADE IN GERMANY



MAIN FEATURES



Analog inputs $\pm 20\text{mV}$ (4 channels)



Embedded data logger up to 1 million data points



Wireless transmission IEEE 802.15.4 with antenna diversity



Integrated rechargeable Lithium-Ion battery



Integrated sensor power supply, software configurable 4.5V to 20V

APPLICATIONS



Structural Health Monitoring

Condition monitoring

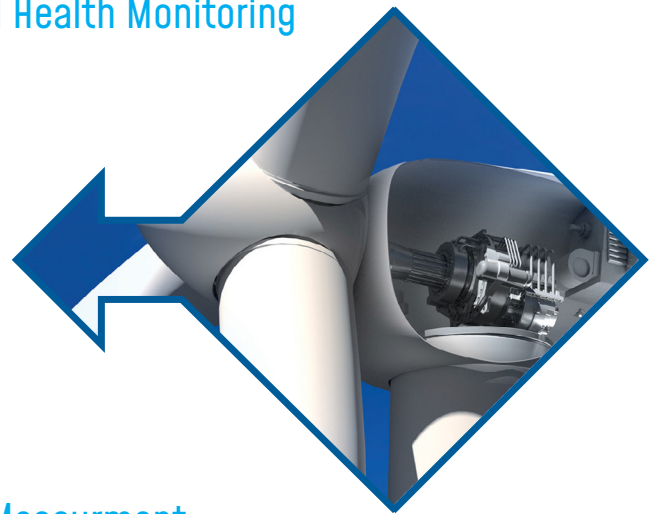

Test and Measurement

EMBEDDED DATA LOGGER UP TO 1 MILLION DATA POINTS

The **BeanDevice® 2.4GHz AN-mV** integrates an embedded data logger, which can be used to log data when a Wireless IIOT Sensors can not be easily deployed on your site. All the data acquisitions are stored on the embedded flash and then transmitted to the **BeanGateway® 2.4GHz** whenever a Wireless IIOT Sensors is established.

The Datalogger function is compatible with all the data acquisition mode available on your **BeanDevice® 2.4GHz AN-mV** :

- LowDutyCycle Data Acquisition
- Survey
- Streaming packet

EXAMPLE : DATA ACQUISITION SYSTEM FOR TECHNICAL BUILDING MANAGEMENT

- The **BeanDevice® 2.4GHz AN-mV** is configured with its Datalogger feature. A standalone installation of the **BeanDevice® 2.4GHz AN-mV** will be done (mounted on the walls), without the necessity for any connection to the **BeanGateway® 2.4GHz**.
- Once the sensors are connected, each data is recorded on the embedded flash.
- When needed a technician working on the site can send a request for a log transmission. Then the **BeanDevice® 2.4GHz AN-mV** starts sending all its logs. If all the logs are successfully transmitted to the **BeanGateway® 2.4GHz**, the flash memory is erased and new logs will be recorded.

BeanDevice® 2.4GHz AN-mV



BeanDevice
2.4 GHz AN-mV

The Datalogger feature is activated on the BeanDevice®



Transmits all the data logs

Request for Logs transmission



i For further information about data logger, please read the following technical note :
TN-RF-007 – “BeanDevice® Datalogger User Guide ”

REMOTE CONFIGURATION & MONITORING

BeanScope® 2.4GHz Basic

The BeanScope® 2.4GHz application allows the user to view all the data measurements transmitted by the BeanDevice® 2.4GHz AN-mV. With the OTAC (Over-the-Air configuration) feature, the user can remotely configure the BeanDevice® 2.4GHz AN-mV.

SEVERAL DATA ACQUISITION MODES ARE AVAILABLE ON THE BEANDEVICE® 2.4GHz AN-mV :

- **Low Duty Cycle Data Acquisition mode (LDCDA)** : the data acquisition is immediately transmitted by radio. The transmission frequency can be configured from 1s to 24h.
- **Survey Mode** : the measured value is transmitted by radio whenever an alarm threshold (fixed by the user) is detected (4 alarms threshold levels High/Low). Meanwhile, the device sends frequently a beacon frame informing its current status.
- **Streaming Packet Mode** : All measured values are transmitted by packet within a continuous flow at 400 samples per second

BeanScope® 2.4GHz Premium+ Add-on

The BeanScope® 2.4GHz Premium+ integrates an OPC DA server (Data Access). OPC DA is particularly well suited for real time measurement and data sharing. Each data/measurement can be associated to a tag or its attributes and shared with one or many OPC clients

BeanDevice® 2.4GHz AN-mV



For further information about data logger, please read the following technical note :
[TN-RF-008-Data-acquisition-modes-available-on-the-BeanDevice](#)

TECHNICAL SPECIFICATIONS

PRODUCT REFERENCE

BND-2.4GHZ-AN-mV-4CH

ANALOG DATA ACQUISITION SPECIFICATIONS

Signal Conditioning	Analog low voltage mV
Number of analog inputs	4 Channels
A/D Converter	16 bits - SAR Architecture (Successive Approximation Register) with temperature compensation
Measurement range	±20 mV (bipolar) or 0-40 mV (unipolar)
Non-linearity error	± 0.5 LSB
Measurement accuracy(@25°C)	< 0,2% when the BeanDevice® is connected to an external power supply
Sensor Connector	M12-4Pins coming with an IP rating IP67

SENSOR POWER SUPPLY SPECIFICATIONS

Excitation voltage range	4.5 Volts to 20Volts , configurable from the BeanScape® software
Excitation voltage accuracy on full scale range(@25°C)	±0.1%
Maximum Output Power (@25°C)	1 Watts

TECHNICAL SPECIFICATIONS

POWER SUPPLY

Integrated battery charger	Integrated Lithium-ion battery charger with high precision battery monitoring : · Overvoltage Protection, Overcurrent/Short-Circuit Protection, Undervoltage Protection · Battery Temperature monitoring
Current consumption @ 3.3V	· During data acquisition : 70mA to 130 mA (depends on external sensor power supply) · During Radio transmission : 70 mA · During sleeping: < 35 µA
External power supply	External power supply : +8v to +28v
Rechargeable battery	Lithium-Ion high density rechargeable battery capacity of 950 mAh

OVER-THE-AIR CONFIGURATION (OTAC) PARAMETERS

Data Acquisition mode	Low Duty Cycle Data Acquisition (LDCDA) Mode: 1s to 24 hour Survey mode: 1s to 24 hour Streaming Mode: 400 SPS maximum
Sampling Rate (SPS = samples per second)	Minimum: 1 SPS Maximum: 400 SPS maximum per channel
Alarm Threshold	2 high levels alarms & 2 low levels alarms
Sensor power supply	4.5 to 20 Volts
Analog Input polarity	Bipolar or Unipolar
Power Mode	Sleep & Active

RF SPECIFICATIONS

Wireless Protocol Stack	Ultra-Power and license-free 2.4Ghz radio technology (IEEE 802.15.4E)
WSN Topology	Point-to-Point / Star
Data rate	250 Kbits/s
RF Characteristics	ISM 2.4GHz – 16 Channels
TX Power	+18 dBm
Receiver Sensitivity	-104 dBm
Maximum Radio Range	650m (Line of Sight) , 30-100m (Non Line of Sight)
Antenna diversity	· 2 omnidirectional N-Type antenna · Gain 5 dBi · Waterproof IP67

EMBEDDED DATA LOGGER

Storage capacity	up to 1 million data points
Wireless data downloading	3 minutes to download the full memory (average time)

TECHNICAL SPECIFICATIONS

TIMESYNC FUNCTION : CLOCK SYNCHRONIZATION OVER THE WIRELESS SENSOR NETWORKS (WSN)

Clock synchronization accuracy	±2.5 ms (at 25°C)
Crystal specifications	Tolerance ±10ppm, stability ±10ppm

ENVIRONMENTAL AND MECHANICAL

Casing	Aluminum, Watertight IP65 – Fire Protection : ULV94/Getex casing dimensions (w/o antenna) L x l x h : 146.05mm x 65.5mm x 33.5mm / Weight : 550g
Shocks resistancet	50g during 50 ms
Operating Temperature	-20 °C to +65 °C during battery discharge 0 to 45°C during battery charge
Norms	· CE Labelling Directive R&TTE (Radio) ETSI EN 300 328 · FCC (North America) ROHS - Directive 2002/95/EC

OPTION(S)

External Power Supply	Wall plug-in, Switchmode power Supply 12V @ 1,25A with sealed M8 Plug (IP67/Nema 6) Ref: M8-PWR-12V
M8 extension cable for external power supply	Molded cable with M8-3pins male plug Material: PVC with shield protection IP Rating : IP67 Nema 6 Cable length: 2 meters , Ref: CBL-M8-2M Cable length : 5 meters, Ref: CBL-M8-5M Cable length: 10 meters, Ref: CBL-M8-10M
M12 Plastic ABS plug for sensors	M12-4 Pins Male plug for sensor interface Coding : A , Locking type: Fix screw, Material: Plastic ABS IP Rating: IP67 in locked condition Ref: M12-PL-SENSOR
M12 Aluminum plug for sensors	M12-4 Pins Male plug for sensor interface Coding : A , Locking type: Fix screw, Material: Aluminum IP Rating: IP67 in locked condition Ref: M12-AL-SENSOR
Antenna cable	N-Type cable (Male/Male), Cable type: RF-5/H155 Cable length: 1 meter, Ref: CBL-ANT-1M Cable length: 2 meters, Ref: CBL-ANT-2M Cable length: 3 meters, Ref: CBL-ANT-3M Cable length: 5 meters, Ref: CBL-ANT-5M Cable length: 10 meters, Ref: CBL-ANT-10M

TECHNICAL SPECIFICATIONS

High Gain antenna option

High Gain Omnidirectional antenna
Frequency range 2400-2500MHz
VSWR < 1.4, Impedance 50 Ohm, Polarization Vertical
Vertical plane 24°(7dBi Gain version) 16°(7dBi Gain version)
6°(12dBi Gain version), Horizontal plane 360°
Connector N female, Wind load (170km/h) 7.3N
Included: N-Type cable (Male/Male), length: 1 meter
Gain: 7dBi, Dimensions 360mm x 23mm, Weight 0.44 kg
Ref: HG-OMNI-OUT-7DBI
Gain: 9dBi, Dimensions 540x23 mm, Weight 0.61 kg
Ref: HG-OMNI-OUT-9DBI
Gain: 12dBi, Dimensions: 1125mm x 19 mm, Weight 1.06 kg
Ref: HG-OMNI-OUT-12DBI

Calibration certificate

Calibration certificate linked to German Accreditation Body (DAkKS)

M 12 Socket Pin assignation

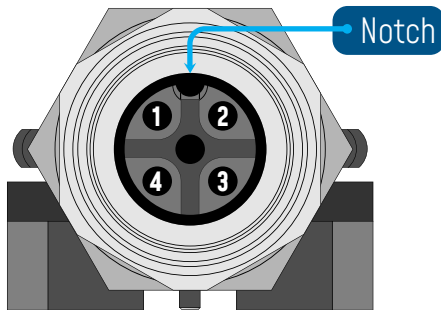

M 12 Socket Positioning Notch

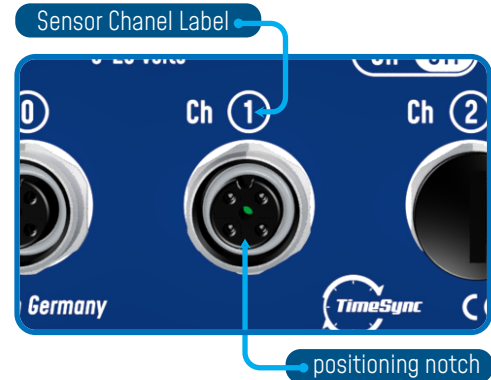

Wiring Code (Sensor Side)-Sensor with Analog Unipolar Output

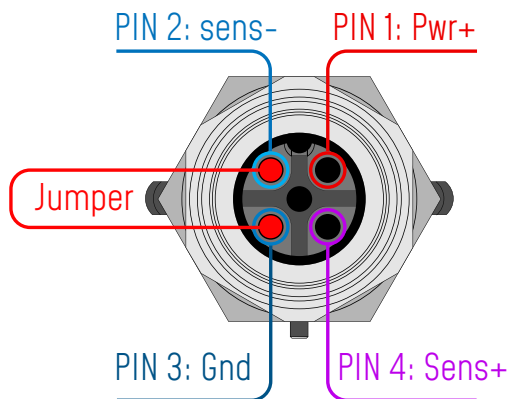

Sensor Wiring Code

CAPTION

PIN1 [Pwr+] : Sensor power supply
PIN 4 [Sens +] : Sensor Signal + input
PIN 2 : Connected to Electrical Ground
PIN 3 [Gnd] : Electrical Ground

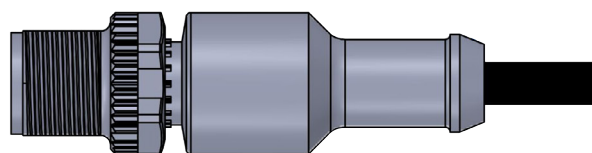

M12-4 Pins Plug

GETTING STARTING WITH A WIRELESS IIOT SENSORS

Wiring Code (Sensor Side)-Sensor with Analog Bipolar Output

CAPTION

- PIN1 (Pwr+)** : Sensor power supply
- PIN 4 (Sens +)** : Sensor Signal + input
- PIN 2** : Sensor signal - input
- PIN 3 (Gnd)** : Electrical Ground

Sensor Wiring Code

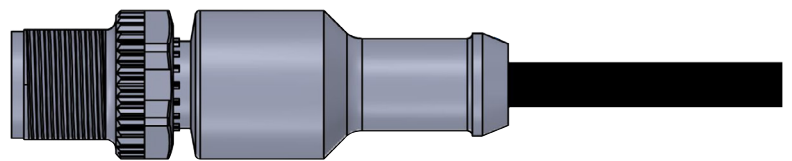
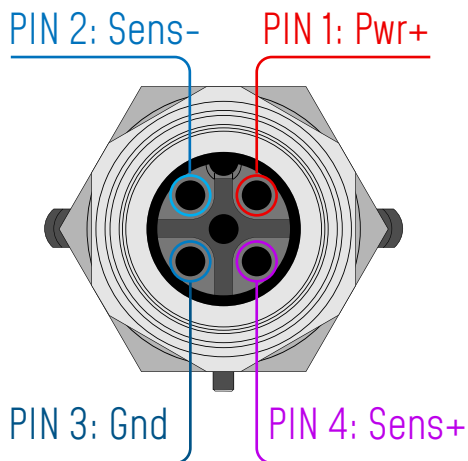

M12-4 Pins Plug

- If you use a unipolar analog sensor, Sens- pin must be connected to the electrical ground

CONFIGURABLE SENSOR POWER SUPPLY

The sensor is directly powered by a high accuracy and adjustable DC/DC converter integrated inside the device. The excitation voltage is remotely configurable through the [BeanScope® 2.4GHz](#) (4.5 to 20V).

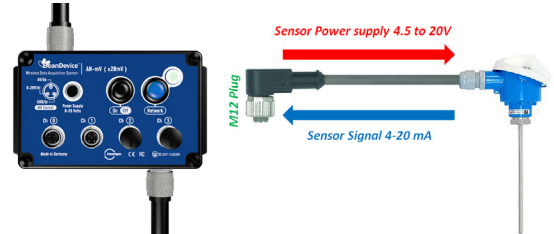

GETTING STARTING WITH A WIRELESS IIOT SENSORS

The [BeanDevice® 2.4GHz AN-mV](#) operates only on our Wireless IIOT Sensors, you will need the [BeanGateway® 2.4GHz](#) and the [BeanScope® 2.4GHz](#) for starting a wireless IIOT sensors



OR



OPC server is only available on the [Beanscope® 2.4GHz Premium +](#)



Wireless IIOT Sensors Supervision software

Product specifications are subject to change without notice.
Contact Beanair for latest specifications.

BeanDevice® 2.4GHz AN-mV

PRODUCT OVERVIEW

ON/Off push button

Network Reset non-contact push button

M8-3 Contacts Socket for external power supply

Activity/Failure led

Eyelet for wall mounting

M12-4Pins female socket for sensor interface

2.4GHz Radio Antenna



ProcessSensor

ACCESSORIES

AC/DC Power supply

Ref: M8-PWR-12V

- Wall plug-in power supply, Output: 12VDC, M8-3Pins plug
- AC Power plug: Europe/UK Northamerica /China/Australia
- Waterproof - IP67



N-Type cable (Male/Male)

Ref: CBL_ANT_XXM

- . length: 1 meter / 2 meters / 5 meters / 10 meters
- . Cable type: RF-5/H155



Omnidirectiona antenna 5dBi for outdoor use

Ref: HG_OMNI_5_OUT_DBI

- Waterproof design
- Outdoor use
- Professional N-type design reduces stress
- N-type, Male, Reverse Polarity, VSWR < 2.0 / Length=95mm
- Wind survival: up to 180Mph
- Watertight IP65
- Waterproof - IP67



Molded Cable with M8 plug

Ref: CBL-M8-2M

- [cable length : 2 meters]
- CBL-M8-5M [cable length : 5 meters]
- CBL-M8-10M [cable length : 10 meters]



M12-5 Pins plug for sensor interface

M12-5 Pins plug for sensor interface

Ref: M12-PL-SENSOR

watertight IP67 - Material: Plastic ABS

M12-5 Pins plug for sensor interface

Ref: M12-AL-SENSOR

watertight IP67 - Material: Aluminum case



CONTACT US

Headquarter:

BeanAir GmbH
Wolfener Straße 32 - 34
12681 Berlin

Email:

info@beanair.com

Phone number:

+49 30 98366680



www.industrial-wsn.com



www.facebook.com/BeanAir



www.beanair.com



www.youtube.com/user/BeanairSensors



www.twitter.com/beanair

