



More Precision

capa**NCDT** MD6-22 // Mobile gap gauge





- High-precision gap measurement
- Intuitive operation
- For electrically conductive measurement objects
- Comprehensive sensor portfolio
- Cable lengths up to 4 m

Mobile gap measurement at the highest precision

The capaNCDT MD6-22 gauge is a capacitive dual-channel handheld gauge which is compatible with all capacitive sensors from Micro-Epsilon.

This measuring system is used in mobile gap and distance measurements and impresses with high accuracy, versatile application possibilities and intuitive operation.

Supported with up to 5h battery life and storage of measurement data on SD card, the MD6-22 is ideally suited to mobile applications in service and maintenance tasks. For example, it is used for rotor gap monitoring in wind turbines and to measure the air gap between the turbine blade and the housing.

This handheld measuring instrument offers three different measurement modes:

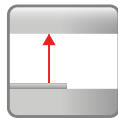

Gap Measurement (single-sided)
One or two flat sensors for single-sided gap measurement are used.

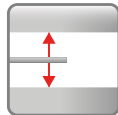

Gap Measurement (double-sided)
One flat sensor for double-sided gap measurement is used.

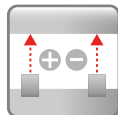

Raw Measurement
Two distance sensors are used which can be calculated together.

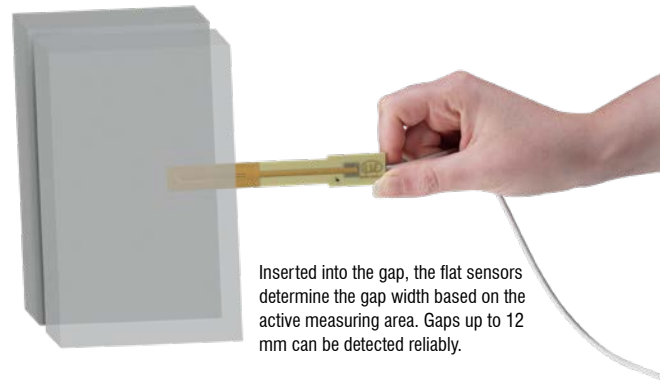

Inserted into the gap, the flat sensors determine the gap width based on the active measuring area. Gaps up to 12 mm can be detected reliably.

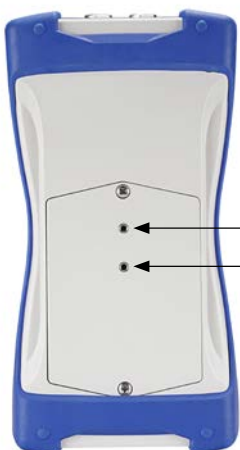

Scope of supply

- Robust carry case
- Handheld measuring instrument MD6-22
- capaNCDT sensor with integrated cable
- Power supply unit / international / 24V / DC / 1A
- Magnetic holder incl. Allen wrench for installation
- 4 x batteries NiMH / Mignon (AA, HR6)
- Cable for ground connection



Rotor gap measurement in the generator

The MD6-22 is used for commissioning and maintenance of generators. Inserted into the rotor gap, the flat sensors detect the distance.

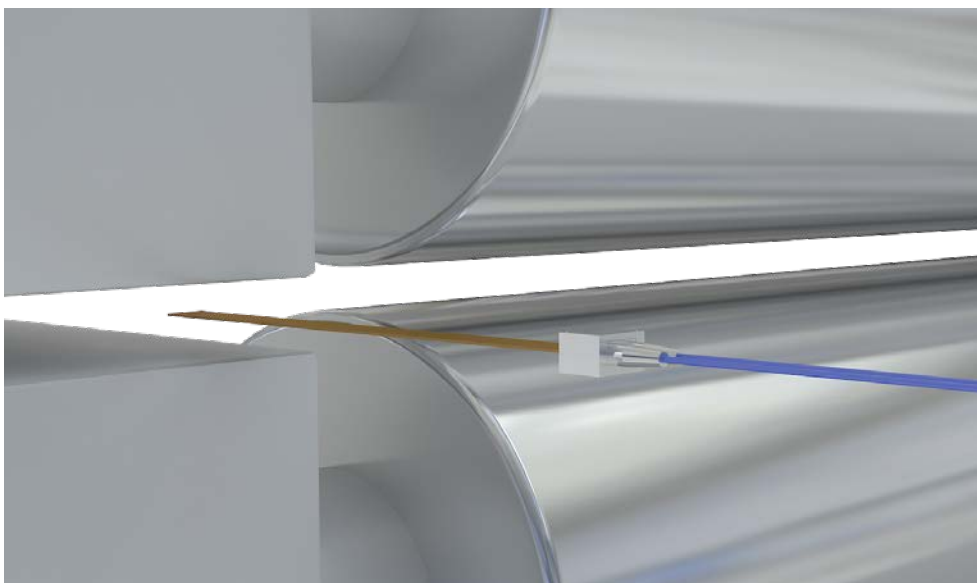
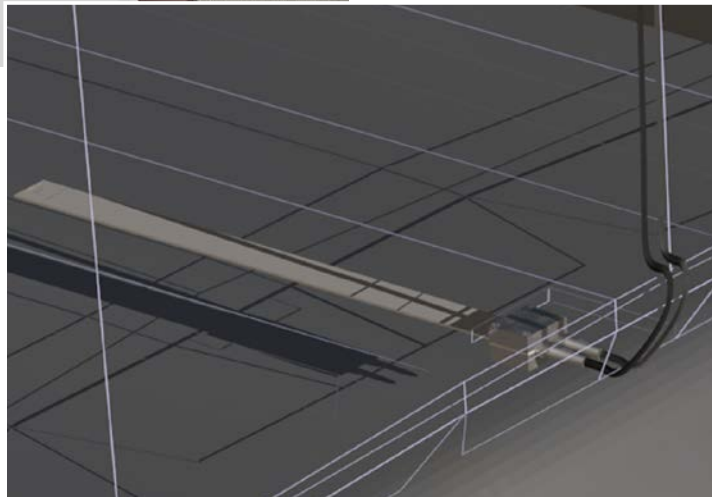

Alignment of rollers

The MD6-22 is used to adjust rollers. Used in commissioning and service tasks, the double-sided flat sensor determines the roller gap.



Mobile gap gauge

The MD6-22 handheld gauge calculates the sensor signals. It has two connections for two sensors or one dual-channel sensor. The rear magnet enables on-site mounting. Based on intuitive touch operation, all parameters can be set quickly. The measurement values are displayed and can be stored on an SD card.

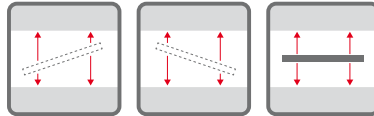

Automatic gap detection

Automatic gap detection simplifies parallel alignment of flat sensors for double-sided measurements, while the sensor is rotated around its longitudinal axis. The system recognizes the correct gap width and displays it.

Calibrated system for measurements independent of the alloy

The capacitive measuring principle enables measurements on all conductive measurement objects. The sensor and the controller are factory-calibrated and matched to one another. When replacing the sensors, recalibration in the factory is recommended in order to maintain the high measurement accuracy. Up to 5 different characteristic curves can be stored in the handheld gauge.

| | | MD6-22 |
|---------------------------------|------------------|---|
| Resolution | (dynamic 100 Hz) | 0.02 % FSO |
| Frequency response (-3dB) | | 100 Hz |
| Linearity | | < ± 0.2 % FSO |
| Temperature stability | | < 200 ppm FSO / K |
| Sensitivity | | < ± 0.2 % FSO |
| Long-term stability | | < 0.04 % FSO/ month |
| Synchronization | | yes |
| Connection | | 2 x sockets (type B) |
| Temperature range | Operation | +10 ... +50 °C |
| | Storage | -10 ... +65 °C |
| Shock (DIN-EN 60068-2-27) | | 40 g / half-sine 6 ms in XYZ axes / 1000 shocks per axis |
| Vibration (DIN-EN 60068-2-64) | | 10 rms / 10 ... 500 Hz in XYZ axes / 30 minutes per axis |
| Protection class (DIN-EN 60529) | | IP30 |
| No. of measurement channels | | 2 |
| Weight | | 500 g (without magnetic holder) |
| Battery life | | 5 hours (with 2500 mAh) |
| Control and display element | | touch display |
| Features | | 2 synchronized measurement channels; compatible with all capaNCDT sensors Storage of measured values on micro SC/SDHC card (not included, max. storage capacity 32 GB) |

FSO = full scale output

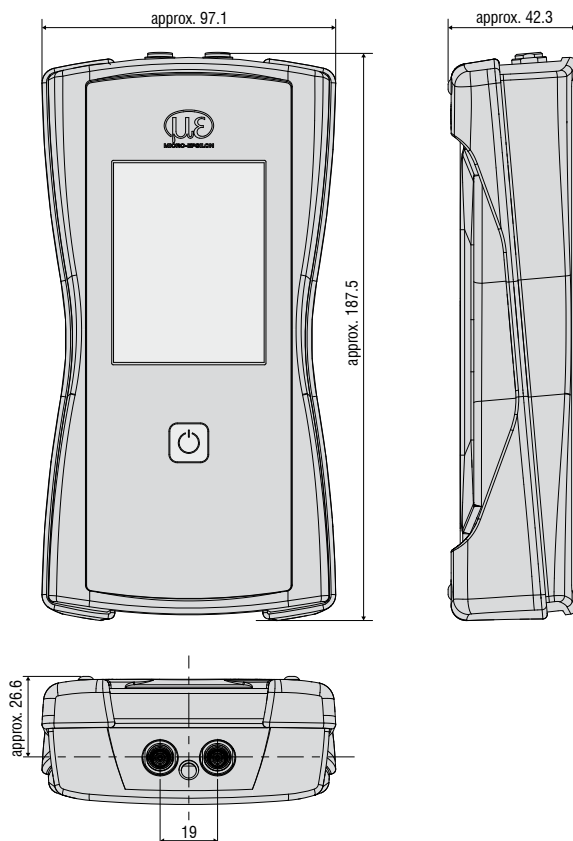

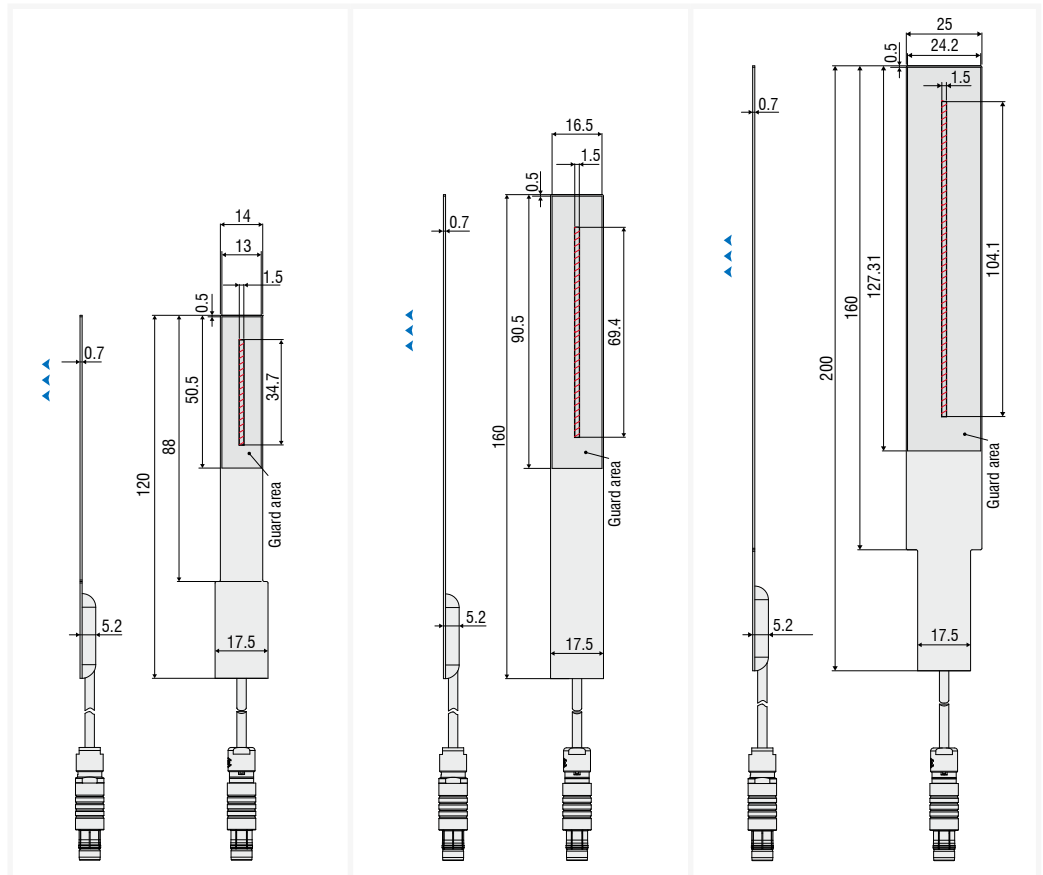
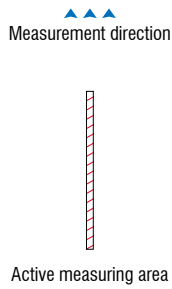

| Model | | CSF2-CRg4.0 | CSF4-CRg4.0 | CSF6-CRg4.0 |
|--|-----------|--|------------------------|------------------------|
| Measuring range | reduced | 1 mm | 2 mm | 3 mm |
| | nominal | 2 mm | 4 mm | 6 mm |
| | expanded | 4 mm | 8 mm | 12 mm |
| Linearity ¹⁾ | | < ± 4 μm | < ± 8 μm | < ± 12 μm |
| Resolution ¹⁾ | dynamic | 0.4 μm | 0.8 μm | 1.2 μm |
| Temperature stability ²⁾ | | < 0.2 μm/K | < 0.4 μm/K | < 0.6 μm/K |
| Temperature range | Operation | | -40 ... +100 °C | |
| | Storage | | -40... +100 °C | |
| Humidity ³⁾ | | | 0 ... 95 % r.H. | |
| Required gap width | | | ≥ 0.75 mm | |
| Min. target size (flat) | | approx. 50.5 x 14 mm | approx. 90.5 x 17.5 mm | approx. 127.31 x 25 mm |
| Shock (DIN-EN 60068-2-29) ⁴⁾ | | 30 g / 5 ms in XY axes / 1000 shocks per axis | | |
| Vibration (DIN-EN 60068-2-6) ⁴⁾ | | 20 g / 58 Hz ... 2000 Hz in XY axes / 10 cycles per axis | | |
| Protection class (DIN-EN 60529) | | IP40 | | |
| Weight | | 75 g | 77 g | 80 g |
| Material | | hard tissue (GFRP) | | |
| Connection | | integrated sensor cable, 4 m | | |

¹⁾ valid for operation with MD6-22 and nominal measuring range

²⁾ valid for disassembled state

³⁾ non condensing

⁴⁾ with locked connector

Connector type B

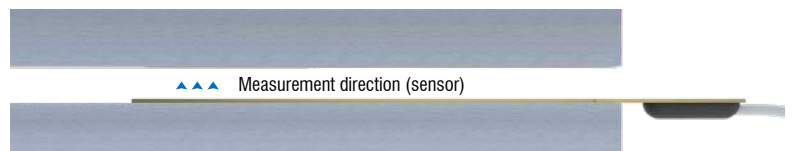
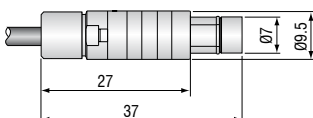

Minimum bending radius (sensor cable) > 10 mm, dynamic > 22 mm (30 mm recommended)

Measurement direction

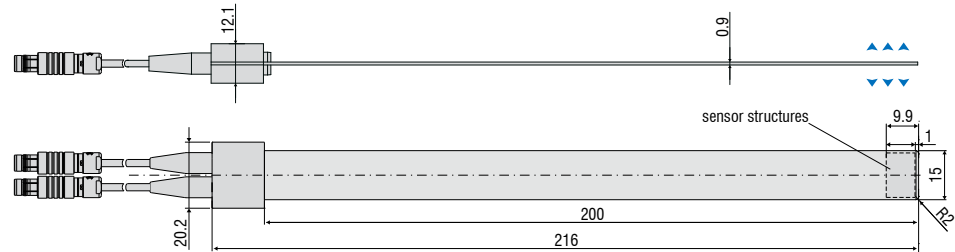

Active measuring area

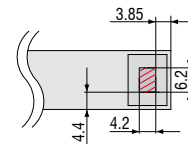
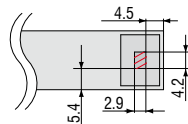

| Model | | CSG0,5-CAm2,0 | CSG1,0-CAm2,0 |
|--|-----------|--|---------------|
| Measuring range ¹⁾ | reduced | 0.25 mm | 0.5 mm |
| | nominal | 0.5 mm | 1 mm |
| | expanded | 1 mm | 2 mm |
| Linearity ²⁾ | | < ± 1 μm | < ± 2 μm |
| Resolution ²⁾ | dynamic | 0.4 μm | 0.8 μm |
| Temperature stability | | < 0.08 μm/K | < 0.1 μm/K |
| Temperature range | Operation | -50...+100 °C | |
| | Storage | -50...+100 °C | |
| Humidity ³⁾ | | 0 ... 95 % r.H. | |
| Required gap width | | ≥ 0.9 mm | |
| Min. target size (flat) | | approx. 9.9 x 15 mm | |
| Shock (DIN-EN 60068-2-29) ⁴⁾ | | 30 g / 5 ms in XY axes / 1000 shocks per axis | |
| Vibration (DIN-EN 60068-2-6) ⁴⁾ | | 20 g / 50 Hz ... 2000 Hz in XY axes / 10 cycles per axis | |
| Protection class (DIN-EN 60529) | | IP40 | |
| Weight | | 77 g | |
| Material | | hard tissue (GFRP) | |
| Connection | | integrated sensor cable, 2 m | |

¹⁾ Measuring range per measurement direction

²⁾ valid for operation with MD6-22 and nominal measuring range

³⁾ non condensing

⁴⁾ with locked connector

Connector type B

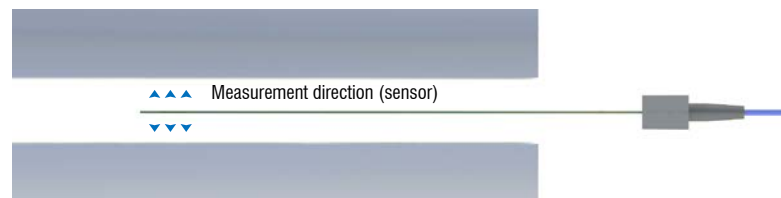
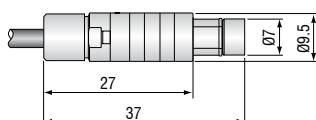

Minimum bending radius (sensor cable) > 7 mm, dynamic > 15 mm (25 mm recommended)

Sensors and Systems from Micro-Epsilon



Sensors and systems for displacement, distance and position



Sensors and measurement devices for non-contact temperature measurement



Measuring and inspection systems for metal strips, plastics and rubber



Optical micrometers and fiber optics, measuring and test amplifiers



Color recognition sensors, LED analyzers and inline color spectrometers

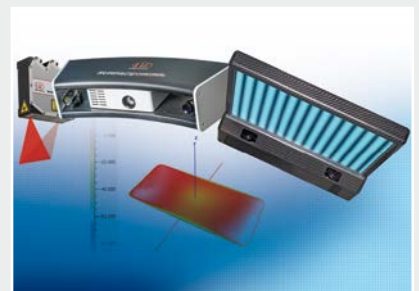

3D measurement technology for dimensional testing and surface inspection