



More Precision

colorCONTROL MFA // Sensor system for LED tests



Sensor system for LED tests

colorCONTROL MFA

Multipoint color recognition system

Series with 7 detection points:
MFA-7, MFA-14, MFA-21, MFA-28

Color inspection in the XYZ, xyY and
RGB color spaces

Color distinction, intensity test and
functional test

Output of the dominant wavelength
(λ_{dom}) and color temperature (CCT)



Features:

- Universal coupling of MFS receiver sensors
- Available with either 7, 14, 21 or 28 measurement channels
- Individual adaption of the sensor configuration
- Each measuring position is freely configurable in terms of color, intensity and function
- Integration into testing process via RS232, RS422 or USB interface
- Output of XYZ-, xyY-, Luv-, uvL-, RGB-, CCT-, λ_{dom} -values
- Exchangeable MFS receiver sensors
- Sensor cables with max. 2m-plastic fiber or with max. 5m-glass fibers
- Software for comprehensive evaluation and display

Applications:

- Testing self-luminous objects
- LED tests (binning)
- Indication tests
- Display tests
- Seven-segment display tests
- Front panel tests

Function:

The information about color, intensity and light are directly transmitted from the measuring object to the MFA sensor via single fiber bundles. One MFA-28 simultaneously monitors up to 28 specimens.

The inspection of inaccessible specimens and/or specimens that are situated far apart from one another can easily be achieved using the MFA series, as optical fibers transmit the information to the evaluation unit.

Advantages

- High repeatability
- High measuring rate and dynamics
- Customer-specific MFS sensors (length and design)
- Digital interfaces: USB, RS422 or RS232



Model	MFA-7	MFA-14	MFA-21	MFA-28	
Article number	11094994	11094995	11094996	11094997	
No. of measurement channels	7	14	21	28	
Repeatability ¹⁾	xy < ±0.000025				
Spectral range	400 ... 700 nm				
Sensitivity range	1 ... 50,000 lx				
Measurement values	XYZ, xyY, Luv, uvL, RGB, CCT, λ _{dom}				
Measuring rate ²⁾	< 100 Hz	< 59 Hz	< 40 Hz	< 30 Hz	
Supply voltage	+ 24 V DC ±10 %				
Max. current consumption	500 mA				
Digital interface	USB, RS422 or RS232				
Connection	optical	7 connections or ports for MFS sensors	14 connections or ports for MFS sensors	21 connections or ports for MFS sensors	28 connections or ports for MFS sensors
	electrical	8-pole M12 socket for RS422 / RS232 / USB 4-pin plug for power supply			
Mounting	Screw connection with four through-holes				
Temperature range	Storage	-10 ... +55 °C			
	Operation	+0 ... +50 °C			
Humidity	20 ... 80 % r.H. (non-condensing)				
Shock (DIN EN 60068-2-27)	15 g / 6 ms + in 3 axes, two directions and 1000 shocks each				
Vibration (DIN EN 60068-2-6)	2 g / 10 ... 500 Hz + in 3 axes, 10 cycles each				
Protection class (DIN EN 60529)	Front side	IP20			
Material	Aluminum housing (black coated)				
Weight	247 g	262 g	278 g	293 g	
Compatibility	with all MFS sensors				
Control and display elements	Status LED (green: smooth operation; orange: error; blue: overmodulation)				

¹⁾ Valid for typ. 5 mm LEDs

²⁾ Valid for a baud rate of 115200 and the transmission of the color values plus time stamp. The measuring rate decreases with the transmission of λ_{dom} and CCT.

Dimensions:

Dimensions in mm, not to scale

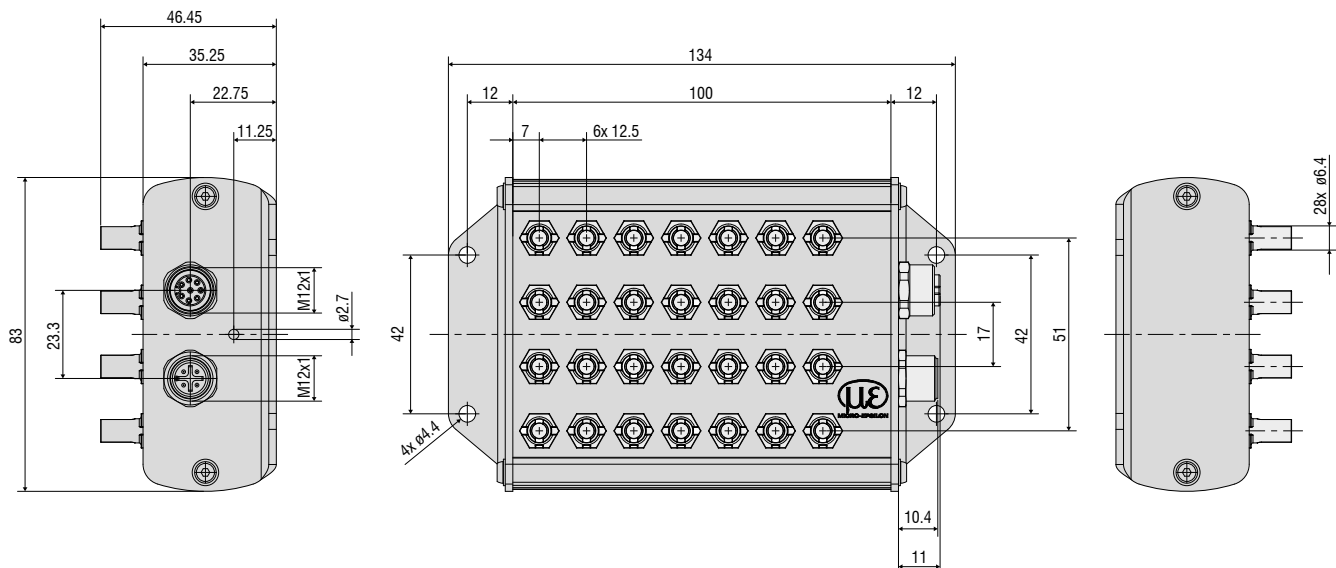

Receiver sensors for testing self-luminous objects

MFS

For LEDs, lamps, bulbs, headlights, backlights, displays

For restricted installation space

Accurate point-by-point testing at various points for individually arranged test items

Detection of smallest objects from 3 mm

Working distance > 3 mm



The light emitted by the luminaire under test is received by the MFS receiving sensor at 0° (parallel) to the direction of emission. The received light beams are transmitted to the controller via an optical fiber. The sensor portfolio covers a wide range of working distances and spot sizes. Other versions in different lengths and temperature ranges are available as options.

The MFS sensor (receiver sensor) in combination with the powerful MFA controllers offers extremely precise testing of light color, intensity, color temperature (CCT) and dominant wavelength (λ_{dom}). This is required, for example, when dividing LEDs into binnings, or for testing homogeneity within a light source with several individual LEDs.

In addition to their outstanding performance, the receiver sensors also impress with extremely advantageous installation options. Due to the external controller, less installation space is required at the measuring point. In addition, measuring points that are further apart can be tested together with a controller.

MFS-22: The MFS-22 consists of a POF (polymer optical fiber) and a PVC sheath with a cut end.

MFS-K04: Guidance via M4 thread enables easy installation, allowing more precise positioning of the sensor.

MFS-K04-3: Smallest measuring spot and best light collection thanks to improved coupling into the fiber.

MFS-K04-6: This sensor has the largest measurement spot, allowing more variable positioning of the test specimens under the sensor. In addition, measurements can be made on a larger illuminated area.

MFS-K05/90: The 90° outlet makes the sensor ideal for installation in restricted spaces where axial mounting is not possible.

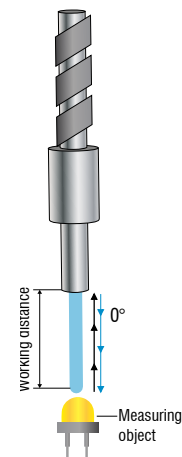

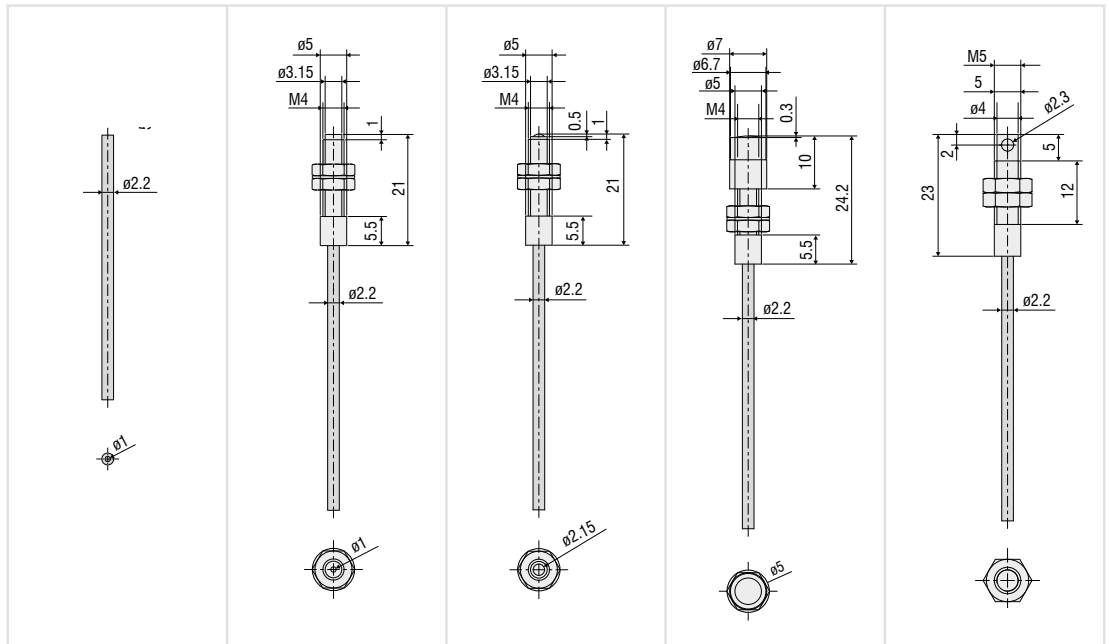

Model	MFS-22	MFS-K04	MFS-K04-3	MFS-K04-6	MFS-K05/90	
Article number	10825504	10825506	10825508	10825510	10825512	
Sensor type	Receiver sensor	Receiver sensor	Receiver sensor	Receiver sensor	Receiver sensor	
Working distance ¹⁾	Start	3 mm	3 mm	3 mm	3 mm	
	Optimal	5 mm	5 mm	5 mm	5 mm	
	End	11 mm	11 mm	15 mm	15 mm	15 mm
Measurement spot diameter ¹⁾	Start	4 mm	4 mm	3 mm	4.5 mm	2x5 mm
	Optimal	6 mm	6 mm	3 mm	5 mm	2.5x6 mm
	End	16 mm	16 mm	6 mm	7 mm	4x14 mm
Measurement geometry	0°	0°	0°	0°	90°	
Min. target size	ø 4 mm	ø 4 mm	ø 3 mm	ø4.5 mm	ø 5 mm	
Sensitivity	Distance ²⁾	xy < 0.003 /mm	xy < 0.003 /mm	xy < 0.002 /mm	xy < 0.003 /mm	xy < 0.004 /mm
	Tilt angle ²⁾	xy < 0.01 / °	xy < 0.01 / °	xy < 0.01 / °	xy < 0.02 / °	xy < 0.02 / °
Connection	integrated plastic fiber cable (axial) with PVC (P) sheath, standard length 0.5 m; other lengths 0.3 m ... 2.0 m optionally available, min. bending radius 50 mm					
Mounting	MFS connector					
Temperature range	Sensor head	-10 ... +80 °C				
	Cable	-20 ... +80 °C				
Humidity	20 ... 80 % r.H. (non-condensing)					
Protection class (DIN EN 60529)	IP64	IP44	IP44	IP44	IP44	
Material	PVC, plastic fiber POF-2,2 with PVC sheath (P)	Aluminum, plastic fiber POF-2,2 with PVC sheath (P)	Aluminum, plastic fiber POF-2,2 with PVC sheath (P)	Aluminum, plastic fiber POF-2,2 with PVC sheath (P)	Aluminum, plastic fiber POF-2,2 with PVC sheath (P)	
Weight	3.4 g	5.4 g	5.6 g	7.2 g	6.7 g	
Compatibility	MFA controller (7, 14, 21, 28)					
Features	All variants are also available with other lengths > 300 mm. Lengths up to 5 m with fiber optic cable are also possible. These can also be produced for vacuum and high temperature.					
No. of measurement channels	1	1	1	1	1	

Data valid in connection with a colorCONTROL MFA-7 controller
¹⁾ Measured with reflector light source white 6500 K, 32 lm, 95 Ra
²⁾ Measured with red 637 nm 5 mm LED (1 mA, 11 V DC)

Applications

colorCONTROL MFA

Color and intensity testing of vehicle headlights

Vehicle headlights are available with different light units. For example, with textured glass, the various built-in lights and lamps are checked for the correct light and glass color.

For LED headlights, for example, the colorCONTROL MFA-7 checks the homogeneity and intensity directly inline without contact.

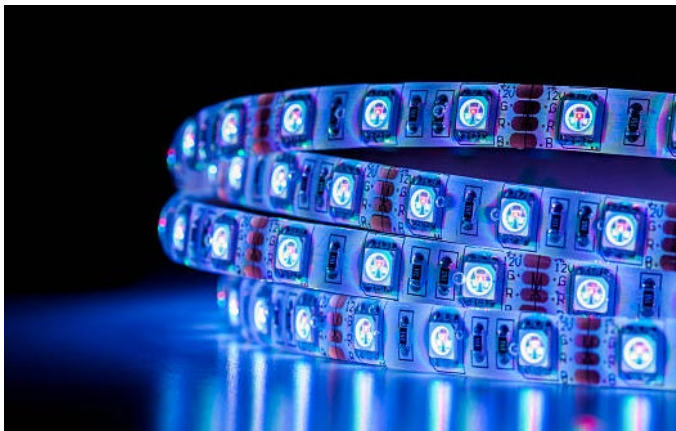

Brightness testing of LED line lights

After the production of LED strips and line lights, a 100 percent inspection of all installed LEDs is carried out in the quality assurance department.

The MFA-28 multi-point color detection system from Micro-Epsilon detects LEDs reliably thanks to its high measuring rate. If up to 5 systems are used, up to 140 LEDs can be tested simultaneously.

LED testing of electronic assemblies

These days, numerous circuit boards are equipped with LEDs. As the sensors are very thin, they can check up to 28 LEDs simultaneously for luminosity and function during the functional test of the board.

The light passing through the sensors to the MFA-28 controller is reliably evaluated. Thus, Micro-Epsilon sensors save time and money in quality assurance.

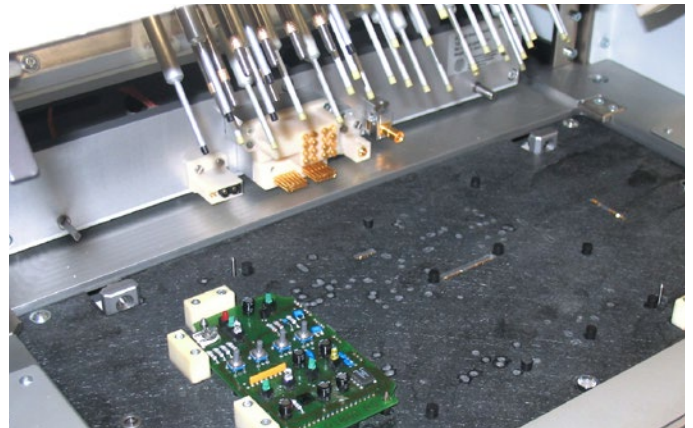

















LED backlights for control panels and operating elements

Kitchen appliances come in different designs with various lighting types. After final assembly, the multicolor LEDs are checked for function and quality using Micro-Epsilon's LED test system.

One of the greatest advantages of the multi-point color detection system is the simultaneous testing of multiple LEDs, which are located in different positions.

Connection cables & Accessories

colorCONTROL MFA

Connection cables		Installation	Sensor
Power supply Power supply unit PS2031 Art. no. 2420096 	Art. no. 11235030 (2 m) 11235031 (5 m) 11235032 (10 m) 		MFA-7 MFA-14 MFA-21 MFA-28 
Process interfaces (USB) 	Art. no. 11235025 (2 m) 		
RS232 	Art. no. 11235027 (2 m) 11235028 (5 m) 11235029 (10 m) 		
RS422 	Art. no. 11234722 (2 m) 11234723 (5 m) 11234725 (10 m) 		
			
			
			

Sensors and Systems from Micro-Epsilon



Sensors and systems for displacement, distance and position



Sensors and measurement devices for non-contact temperature measurement



Measuring and inspection systems for metal strips, plastics and rubber



Optical micrometers and fiber optics, measuring and test amplifiers



Color recognition sensors, LED analyzers and inline color spectrometers



3D measurement technology for dimensional testing and surface inspection