

# Tee Rosettes (General-Use)

## FEATURES

- Gage patterns designed for measuring orthogonal strains
- All patterns have two grids oriented at 0° and 90° angles
- Both stacked and planar constructions available
- Gage lengths from 0.050" (1.27 mm) to 0.250" (6.35 mm)

## PATTERNS

050TG .....	66
062LT .....	67
062TJ .....	68
062TT .....	69
062TZ .....	70
062UT .....	71
062WT .....	72
120WT .....	73
125LT .....	74
125TG .....	75
125TM .....	76
125UT .....	77
125WT .....	78
250TM .....	79
250UT .....	80
Other Tee Rosettes .....	81

## General Purpose Strain Gages – Tee Rosette

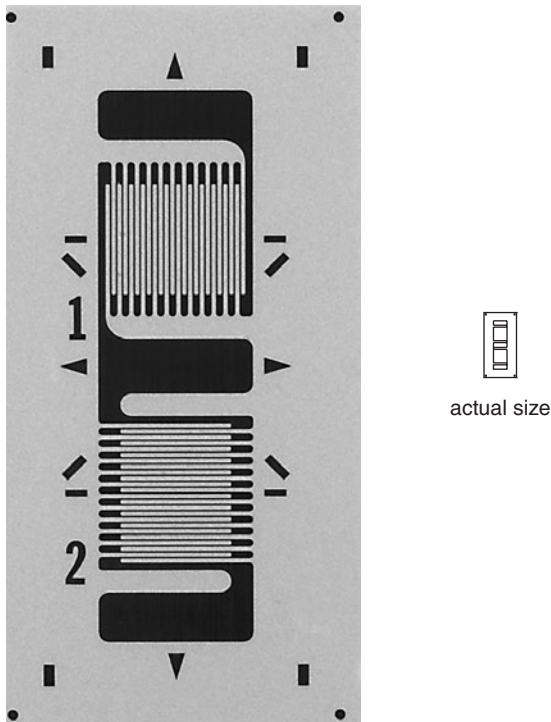
GAGE PATTERN DATA							
 <p>actual size</p>			<b>GAGE DESIGNATION</b> See Note 1, 3	<b>RESISTANCE (OHMS)</b> See Note 2	<b>OPTIONS AVAILABLE</b> See Note 3		
			EA-XX-050TG-350 <b>WA-XX-050TG-350</b> EP-08-050TG-350 <b>SA-XX-050TG-350</b>	350 ± 0.2% 350 ± 0.4% 350 ± 0.2% 350 ± 0.4%	L, LE		
<b>DESCRIPTION</b> Miniature high-resistance 90° tee rosette. Sections have a common solder tab.							
<b>GAGE DIMENSIONS</b>		<b>Legend</b> ES = Each Section      CP = Complete Pattern S = Section (S1 = Section 1)      M = Matrix					
				<table border="1"> <tr><td>inch</td></tr> <tr><td>millimeter</td></tr> </table>	inch	millimeter	
inch							
millimeter							
<b>Gage Length</b>	<b>Overall Length</b>	<b>Grid Width</b>	<b>Overall Width</b>	<b>Matrix Length</b>	<b>Matrix Width</b>		
0.050 ES	0.250 CP	0.070 ES	0.070 CP	0.34	0.17		
1.27 ES	6.35 CP	1.78 ES	1.78 CP	8.6	4.3		



GAGE SERIES DATA — See Gage Series datasheet for complete specifications			
Series	Description	Strain Range	Temperature Range
EA	Constantan foil in combination with a tough, flexible, polyimide backing.	±3%	-100° to +350°F (-75° to +175°C)
WA	Fully encapsulated constantan gages with high-endurance leadwires.	±2%	-100° to +400°F (-75° to +205°)
EP	Annealed constantan foil with tough, high-elongation polyimide backing.	±10%	-100° to +400°F (-75° to +205°C)
SA	Fully encapsulated constantan gages with solder dots.	±2%	-100° to +400°F (-75° to +205°C)

**Note 1:** Insert desired S-T-C number in spaces marked XX.

**Note 2:** Tolerance is increased when Option W, E, SE, LE, or P is specified.

**Note 3:** Products with designations and options shown in **bold** are not RoHS compliant.

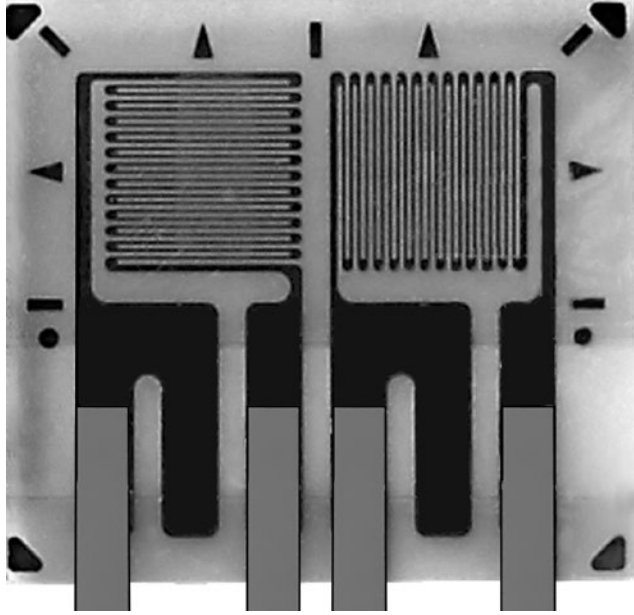
## General Purpose Strain Gages – Tee Rosette

GAGE PATTERN DATA					
 <p style="text-align: center;">actual size</p>			<b>GAGE DESIGNATION</b> See Note 1	<b>RESISTANCE (OHMS)</b>	<b>OPTIONS AVAILABLE</b>
			L2A-XX-062LT-120 L2A-XX-062LT-350 C2A-XX-062LT-120 C2A-XX-062LT-350	120 ± 0.6% 350 ± 0.6% 120 ± 0.6% 350 ± 0.6%	
<b>DESCRIPTION</b> General-purpose 90° rosette.					 <b>RoHS COMPLIANT</b>
<b>GAGE DIMENSIONS</b>		<b>Legend</b> ES = Each Section S = Section (S1 = Section 1) CP = Complete Pattern M = Matrix			<input type="checkbox"/> inch <input type="checkbox"/> millimeter
<b>Gage Length</b>	<b>Overall Length</b>	<b>Grid Width</b>	<b>Overall Width</b>	<b>Matrix Length</b>	<b>Matrix Width</b>
0.062	0.164	0.070	0.170	0.210	0.230
1.52	4.17	1.78	4.32	5.33	5.84

GAGE SERIES DATA — See Gage Series datasheet for complete specifications			
Series	Description	Strain Range	Temperature Range
L2A	Encapsulated constantan gages with preattached ribbon leads.	±3%	-100° to +250°F (-75° to +120°C)
C2A	Encapsulated constantan gages with preattached ready-to-use cables.	±3%	-60° to +180°F (-50° to +80°C)



Example of an  
L2A Construction



Example of an  
C2A Construction

**Note 1:** Insert desired S-T-C number in spaces marked XX.

## General Purpose Strain Gages – Tee Rosette

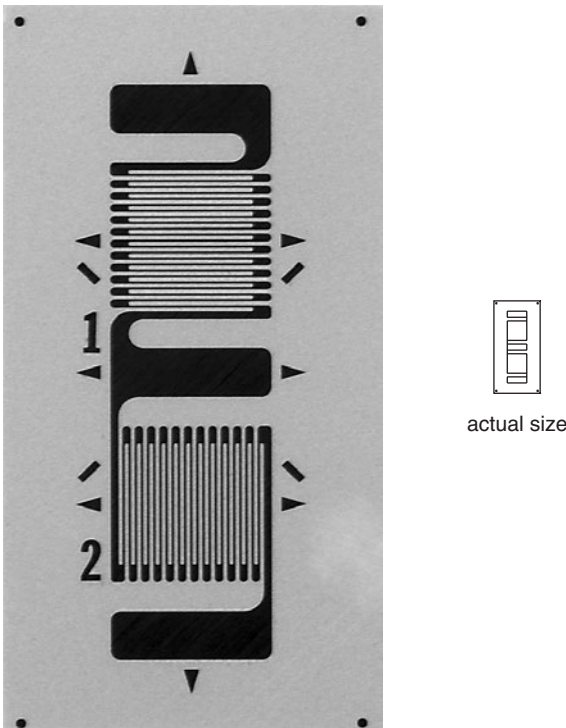
GAGE PATTERN DATA							
		<b>GAGE DESIGNATION</b> See Note 1, 2	<b>RESISTANCE (OHMS)</b>	<b>OPTIONS AVAILABLE</b> See Note 2			
		EA-XX-062TJ-120 EA-XX-062TJ-350 <b>SA-XX-062TJ-120</b> <b>SA-XX-062TJ-350</b>	120 ± 0.2% 350 ± 0.2% 120 ± 0.4% 350 ± 0.4%				
<b>DESCRIPTION</b> General-purpose 90° tee rosette. Sections have a common solder tab.							
GAGE DIMENSIONS		Legend					
		ES = Each Section	CP = Complete Pattern	<table border="1"> <tr> <td>inch</td> </tr> <tr> <td>millimeter</td> </tr> </table>		inch	millimeter
inch							
millimeter							
		S = Section (S1 = Section 1)	M = Matrix				
Gage Length	Overall Length	Grid Width	Overall Width	Matrix Length	Matrix Width		
0.062 ES	0.295 CP	0.080 ES	0.080 CP	0.38	0.19		
1.57 ES	7.49 CP	2.03 ES	2.03 CP	12.2	4.8		

GAGE SERIES DATA — See Gage Series datasheet for complete specifications			
Series	Description	Strain Range	Temperature Range
EA	Constantan foil in combination with a tough, flexible, polyimide backing.	±3%	-100° to +350°F (-75° to +175°C)
SA	Fully encapsulated constantan gages with solder dots.	±2%	-100° to +400°F (-75° to +205°C)

**Note 1:** Insert desired S-T-C number in spaces marked XX.

**Note 2:** Tolerance is increased when Option W, E, SE, LE, or P is specified.

## General Purpose Strain Gages – Tee Rosette

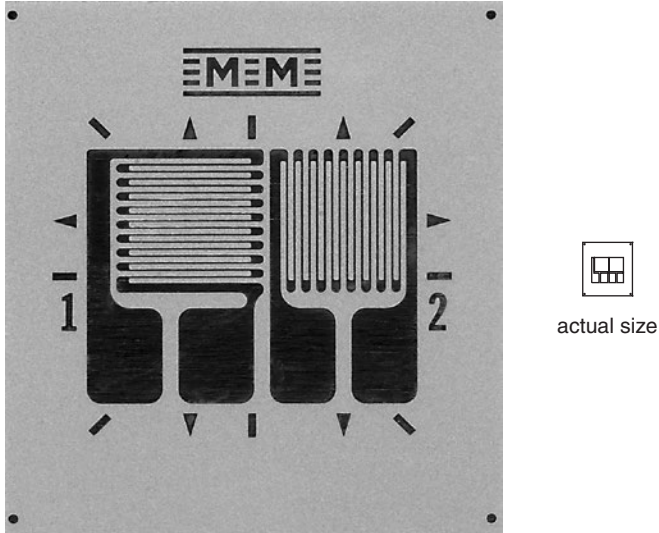
GAGE PATTERN DATA					
		<b>GAGE DESIGNATION</b> See Note 1, 3	<b>RESISTANCE (OHMS)</b> See Note 2	<b>OPTIONS AVAILABLE</b> See Note 3	
		EA-XX-062TT-120 EA-XX-062TT-350 EK-XX-062TT-350 <b>WA-XX-062TT-120</b> <b>WA-XX-062TT-350</b> WK-XX-062TT-350 EP-XX-062TT-120 EP-XX-062TT-350 <b>SA-XX-062TT-120</b> <b>SA-XX-062TT-350</b> <b>SK-XX-062TT-350</b>	120 ± 0.2% 350 ± 0.2% 350 ± 0.2% 120 ± 0.4% 350 ± 0.4% 350 ± 0.4% 120 ± 0.2% 350 ± 0.2% 120 ± 0.4% 350 ± 0.4% 350 ± 0.4%	W, E, L, LE W, E, L, LE W, <b>SE</b> W* W* <b>W*</b>	
<b>DESCRIPTION</b> General-purpose 90° tee rosette. Sections are electrically independent. EK-Series gages are supplied with duplex copper pads (DP) when optional feature W or SE is not specified.					
<b>GAGE DIMENSIONS</b>		<b>Legend</b> ES = Each Section S = Section (S1 = Section 1) CP = Complete Pattern M = Matrix			<input type="checkbox"/> inch <input type="checkbox"/> millimeter
<b>Gage Length</b>	<b>Overall Length</b>	<b>Grid Width</b>	<b>Overall Width</b>	<b>Matrix Length</b>	<b>Matrix Width</b>
0.062 ES	0.133 CP	0.075 ES	0.168 CP	0.28	0.26
1.57 ES	3.38 CP	1.91 ES	4.27 CP	7.1	6.6

GAGE SERIES DATA — See Gage Series datasheet for complete specifications			
Series	Description	Strain Range	Temperature Range
EA	Constantan foil in combination with a tough, flexible, polyimide backing.	±3%	-100° to +350°F (-75° to +175°C)
EK	K-alloy foil in combination with a tough, flexible polyimide backing.	±1.5%	-320° to +350°F (-195° to +175°C)
WA	Fully encapsulated constantan gages with high-endurance leadwires.	±2%	-100° to +400°F (-75° to +205°)
WK	Fully encapsulated K-alloy gages with high-endurance leadwires.	±1.5%	-452° to +550°F (-269° to +290°C)
EP	Annealed constantan foil with tough, high-elongation polyimide backing.	±10%	-100° to +400°F (-75° to +205°C)
SA	Fully encapsulated constantan gages with solder dots.	±2%	-100° to +400°F (-75° to +205°C)
SK	Fully encapsulated K-alloy gages with solder dots.	±1.5%	-452° to +450°F (-269° to +230°C)

**Note 1:** Insert desired S-T-C number in spaces marked XX.

**Note 2:** Tolerance is increased when Option W, E, SE, LE, or P is specified.

**Note 3:** Products with designations and options shown in **bold** are not RoHS compliant.

\*Options available but not normally recommended. See Optional Features datasheet for details.

## General Purpose Strain Gages – Tee Rosette

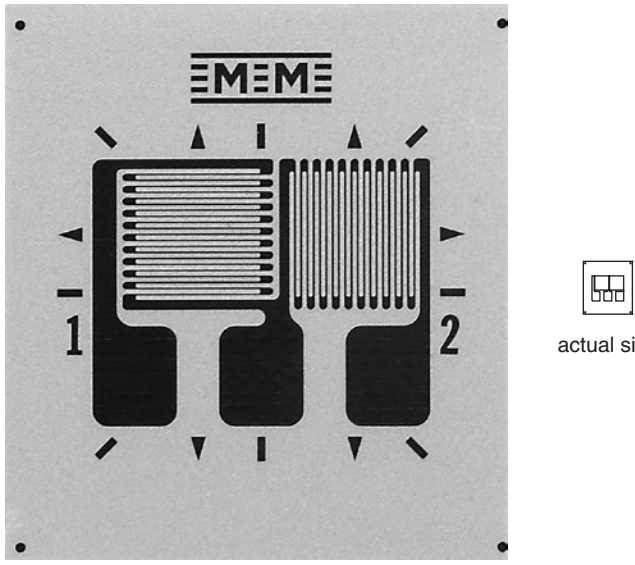
GAGE PATTERN DATA					
 <p>actual size</p>			<b>GAGE DESIGNATION</b> See Note 1, 3	<b>RESISTANCE (OHMS)</b> See Note 2	<b>OPTIONS AVAILABLE</b> See Note 3
			EA-XX-062TZ-350 <b>WA-XX-062TZ-350</b> WK-XX-062TZ-120 <b>SA-XX-062TZ-350</b> <b>SK-XX-062TZ-120</b>	350 ± 0.2% 350 ± 0.4% 120 ± 0.4% 350 ± 0.4% 120 ± 0.4%	W, E, L, LE
<b>DESCRIPTION</b> General-purpose 90° tee rosette. Similar in geometry to 062TT pattern except common tab version.					
<b>GAGE DIMENSIONS</b>		<b>Legend</b> ES = Each Section      CP = Complete Pattern S = Section (S1 = Section 1)      M = Matrix			
				inch	
				millimeter	
<b>Gage Length</b>	<b>Overall Length</b>	<b>Grid Width</b>	<b>Overall Width</b>	<b>Matrix Length</b>	<b>Matrix Width</b>
0.062 ES	0.133 CP	0.075 ES	0.168 CP	0.28	0.26
1.57 ES	3.38 CP	1.91 ES	4.27 CP	7.1	6.6

GAGE SERIES DATA — See Gage Series datasheet for complete specifications			
Series	Description	Strain Range	Temperature Range
EA	Constantan foil in combination with a tough, flexible, polyimide backing.	±3%	-100° to +350°F (-75° to +175°C)
WA	Fully encapsulated constantan gages with high-endurance leadwires.	±2%	-100° to +400°F (-75° to +205°)
WK	Fully encapsulated K-alloy gages with high-endurance leadwires.	±1.5%	-452° to +550°F (-269° to +290°C)
SA	Fully encapsulated constantan gages with solder dots.	±2%	-100° to +400°F (-75° to +205°C)
SK	Fully encapsulated K-alloy gages with solder dots.	±1.5%	-452° to +450°F (-269° to +230°C)

**Note 1:** Insert desired S-T-C number in spaces marked XX.

**Note 2:** Tolerance is increased when Option W, E, SE, LE, or P is specified.

**Note 3:** Products with designations and options shown in **bold** are not RoHS compliant.

## General Purpose Strain Gages – Tee Rosette

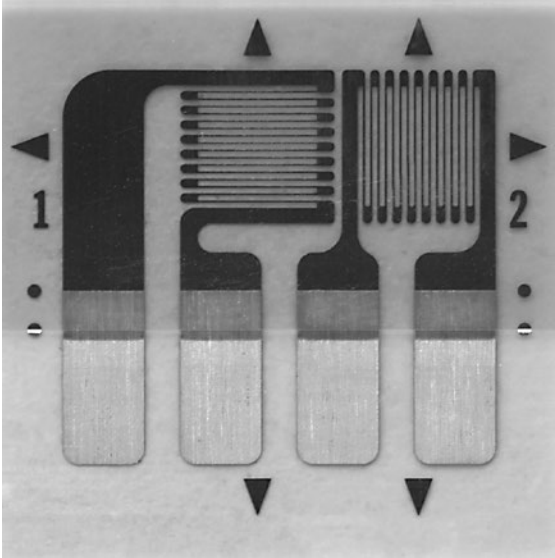

GAGE PATTERN DATA					
 <p style="text-align: center;">actual size</p>			<b>GAGE DESIGNATION</b> See Note 1	<b>RESISTANCE (OHMS)</b>	<b>OPTIONS AVAILABLE</b> See Note 2
			CEA-XX-062UT-120 CEA-XX-062UT-350	120 ± 0.4% 350 ± 0.4%	<b>P2</b> <b>P2</b>
<b>DESCRIPTION</b> Small general-purpose two-element 90° tee rosette. Exposed solder tab area 0.07 x 0.04 in (1.8 x 1.0 mm).					
<b>GAGE DIMENSIONS</b>		<b>Legend</b> ES = Each Section      CP = Complete Pattern S = Section (S1 = Section 1)      M = Matrix			<input type="checkbox"/> inch <input type="checkbox"/> millimeter
<b>Gage Length</b>	<b>Overall Length</b>	<b>Grid Width</b>	<b>Overall Width</b>	<b>Matrix Length</b>	<b>Matrix Width</b>
0.062 ES	0.205 CP	0.080 ES	0.225 CP	0.31	0.31
1.57 ES	5.21 CP	2.03 ES	5.72 CP	7.9	7.9

<b>GAGE SERIES DATA</b> — See Gage Series datasheet for complete specifications			
Series	Description	Strain Range	Temperature Range
CEA	Universal general-purpose strain gages.	±3%	-100° to +350°F (-75° to +175°C)

**Note 1:** Insert desired S-T-C number in spaces marked XX.

**Note 2:** Products with designations and options shown in bold are not RoHS compliant.

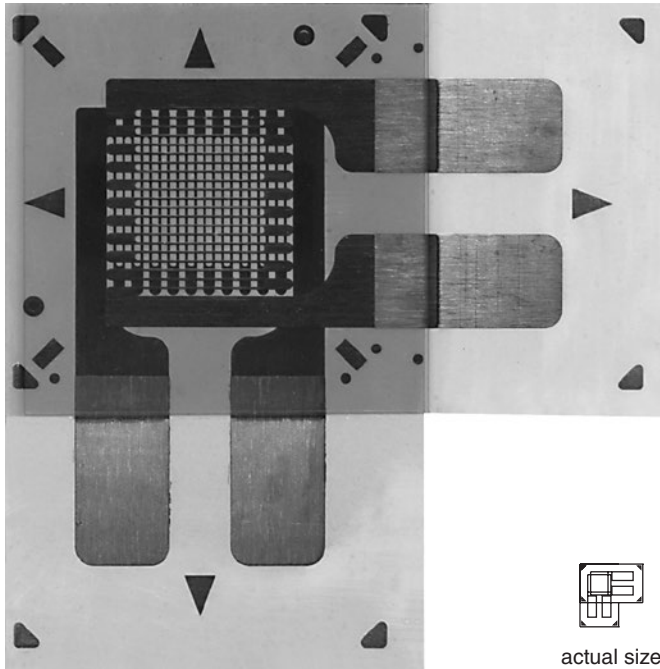
## General Purpose Strain Gages – Tee Rosette

GAGE PATTERN DATA					
  actual size			<b>GAGE DESIGNATION</b> See Note 1	<b>RESISTANCE (OHMS)</b>	<b>OPTIONS AVAILABLE</b>
			CEA-XX-062WT-120 CEA-XX-062WT-350	120 ± 0.5% 350 ± 0.5%	
<b>DESCRIPTION</b> Small two-element 90° stacked rosette. Exposed solder tab area 0.07 x 0.04 in (1.8 x 1.0 mm). Maximum operating temperature +150°F (+65°C).					 <b>RoHS</b> COMPLIANT
<b>GAGE DIMENSIONS</b>		<b>Legend</b> ES = Each Section      CP = Complete Pattern S = Section (S1 = Section 1)      M = Matrix			<input type="checkbox"/> inch <input type="checkbox"/> millimeter
<b>Gage Length</b>	<b>Overall Length</b>	<b>Grid Width</b>	<b>Overall Width</b>	<b>Matrix Length</b>	<b>Matrix Width</b>
0.062 ES	0.235 CP	0.120 ES	0.235 CP	0.33	0.33
1.57 ES	5.97 CP	3.05 ES	5.97 CP	8.3	8.3

GAGE SERIES DATA — See Gage Series datasheet for complete specifications			
Series	Description	Strain Range	Temperature Range
CEA	Universal general-purpose strain gages.	±3%	-100° to +150°F (-75° to +65°C)

**Note 1:** Insert desired S-T-C number in spaces marked XX.



## General Purpose Strain Gages – Tee Rosette

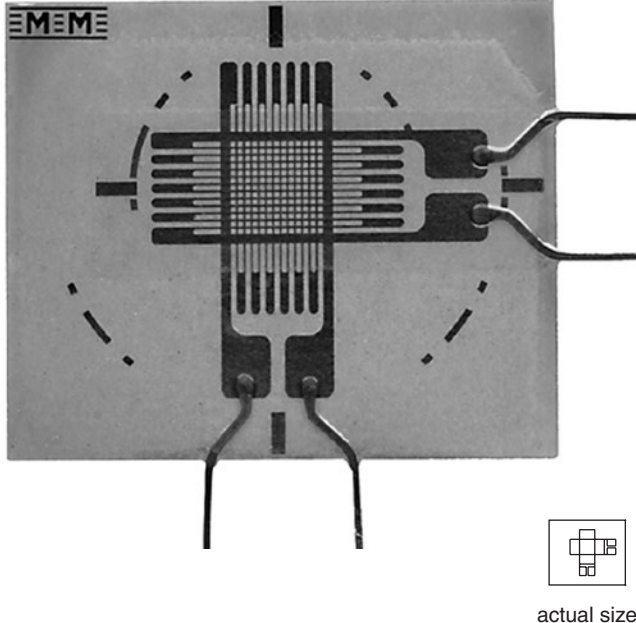

GAGE PATTERN DATA					
			<b>GAGE DESIGNATION</b> See Note 1, 2	<b>RESISTANCE (OHMS)</b>	<b>OPTIONS AVAILABLE</b> See Note 2
			<b>WA-XX-120WT-120</b> <b>WA-XX-120WT-350</b> WD-DY-120WT-350 WK-XX-120WT-120 WK-XX-120WT-350 <b>SA-XX-120WT-120</b> <b>SA-XX-120WT-350</b> <b>SK-XX-120WT-120</b> <b>SK-XX-120WT-350</b> <b>SD-DY-120WT-350</b>	120 ± 0.5% 350 ± 0.5% 350 ± 0.5% 120 ± 0.5% 350 ± 0.5% 120 ± 0.5% 350 ± 0.5% 120 ± 0.5% 350 ± 0.5% 350 ± 0.5%	
			<b>DESCRIPTION</b> Two-element 90° tee stacked rosette. See also 125WT pattern.		
<b>GAGE DIMENSIONS</b>		<b>Legend</b> ES = Each Section      CP = Complete Pattern S = Section (S1 = Section 1)      M = Matrix			
					<input type="checkbox"/> inch <input type="checkbox"/> millimeter
<b>Gage Length</b>	<b>Overall Length</b>	<b>Grid Width</b>	<b>Overall Width</b>	<b>Matrix Length</b>	<b>Matrix Width</b>
0.120 ES	0.34 M	0.080 ES	0.040 M	0.34	0.40
3.05 ES	8.6 M	2.03 ES	10.2 M	8.6	10.2

<b>GAGE SERIES DATA</b> — See Gage Series datasheet for complete specifications			
Series	Description	Strain Range	Temperature Range
WA	Fully encapsulated constantan gages with high-endurance leadwires.	±2%	-100° to +400°F (-75° to +205°)
WD	Fully encapsulated isoelastic gages with high-endurance leadwires.	±1.5%	-320° to +500°F (-195° to +260°C)
WK	Fully encapsulated K-alloy gages with high-endurance leadwires.	±1.5%	-452° to +550°F (-269° to +290°C)
SA	Fully encapsulated constantan gages with solder dots.	±2%	-100° to +400°F (-75° to +205°C)
SK	Fully encapsulated K-alloy gages with solder dots.	±1.5%	-452° to +450°F (-269° to +230°C)
SD	Equivalent to WD Series, but with solder dots instead of leadwires.	±1.5%	-320° to +400°F (-195° to +205°C)

**Note 1:** Insert desired S-T-C number in spaces marked XX.

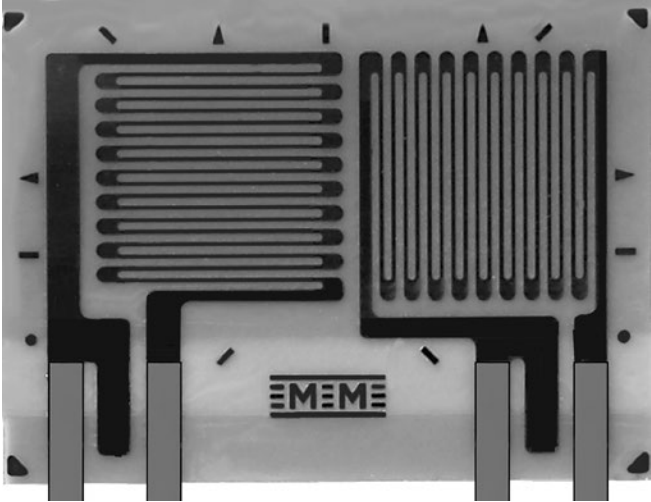

**Note 2:** Products with designations and options shown in bold are not RoHS compliant.

## General Purpose Strain Gages – Tee Rosette

GAGE PATTERN DATA					
  actual size			<b>GAGE DESIGNATION</b> See Note 1	<b>RESISTANCE (OHMS)</b>	<b>OPTIONS AVAILABLE</b>
			L2A-XX-125LT-120 L2A-XX-125LT-350 C2A-XX-125LT-120 C2A-XX-125LT-350	120 ± 0.6% 350 ± 0.6% 120 ± 0.6% 350 ± 0.6%	
<b>DESCRIPTION</b> General-purpose 90° rosette.					 <b>RoHS COMPLIANT</b>
<b>GAGE DIMENSIONS</b>		<b>Legend</b> ES = Each Section      CP = Complete Pattern S = Section (S1 = Section 1)      M = Matrix			inch millimeter
<b>Gage Length</b>	<b>Overall Length</b>	<b>Grid Width</b>	<b>Overall Width</b>	<b>Matrix Length</b>	<b>Matrix Width</b>
0.125 ES	0.243 CP	0.150 ES	0.340 CP	0.290	0.400
3.18 ES	6.17 CP	3.81 ES	8.64 CP	7.37	10.16

GAGE SERIES DATA — See Gage Series datasheet for complete specifications			
Series	Description	Strain Range	Temperature Range
L2A	Encapsulated constantan gages with preattached ribbon leads.	±3%	-100° to +250°F (-75° to +120°C)
C2A	Encapsulated constantan gages with preattached ready-to-use cables.	±3%	-60° to +180°F (-50° to +80°C)

 <p>Example of an L2A Construction</p>	 <p>Example of an C2A Construction</p>
---	--

**Note 1:** Insert desired S-T-C number in spaces marked XX.

## General Purpose Strain Gages – Tee Rosette

GAGE PATTERN DATA							
 <p>actual size</p>			<b>GAGE DESIGNATION</b> See Note 1, 3	<b>RESISTANCE (OHMS)</b> See Note 2	<b>OPTIONS AVAILABLE</b> See Note 3		
			EA-XX-125TG-350 EK-XX-125TG-10C <b>WA-XX-125TG-350</b> <b>SA-XX-125TG-350</b> <b>SK-XX-125TG-10C</b>	350 ± 0.2% 1000 ± 0.2% 350 ± 0.4% 350 ± 0.4% 1000 ± 0.4%	L, LE <b>SE</b>		
<b>DESCRIPTION</b> General-purpose two-element 90° tee rosette with high-resistance grid. Sections have a common electrical connection. EK-Series gages are supplied with duplex copper dots (DD) when optional feature SE is not specified.							
<b>GAGE DIMENSIONS</b>		<b>Legend</b>			<table border="1"> <tr><td>inch</td></tr> <tr><td>millimeter</td></tr> </table>	inch	millimeter
inch							
millimeter							
ES = Each Section	CP = Complete Pattern						
S = Section (S1 = Section 1)	M = Matrix						
<b>Gage Length</b>	<b>Overall Length</b>	<b>Grid Width</b>	<b>Overall Width</b>	<b>Matrix Length</b>	<b>Matrix Width</b>		
0.125 ES	0.500 CP	0.150 ES	0.150 CP	0.61	0.23		
3.18 ES	12.70 CP	3.81 ES	3.81 CP	15.5	5.8		

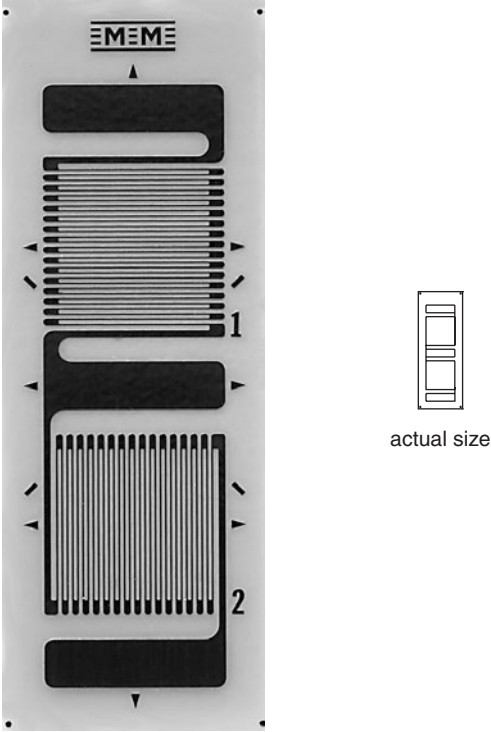

<b>GAGE SERIES DATA</b> — See Gage Series datasheet for complete specifications			
Series	Description	Strain Range	Temperature Range
EA	Constantan foil in combination with a tough, flexible, polyimide backing.	±5%	-100° to +350°F (-75° to +175°C)
EK	K-alloy foil in combination with a tough, flexible polyimide backing.	±1.5%	-320° to +350°F (-195° to +175°C)
WA	Fully encapsulated constantan gages with high-endurance leadwires.	±2%	-100° to +400°F (-75° to +205°)
SA	Fully encapsulated constantan gages with solder dots.	±2%	-100° to +400°F (-75° to +205°C)
SK	Fully encapsulated K-alloy gages with solder dots.	±1.5%	-452° to +450°F (-269° to +230°C)

**Note 1:** Insert desired S-T-C number in spaces marked XX.

**Note 2:** Tolerance is increased when Option W, E, SE, LE, or P is specified.

**Note 3:** Products with designations and options shown in **bold** are not RoHS compliant.

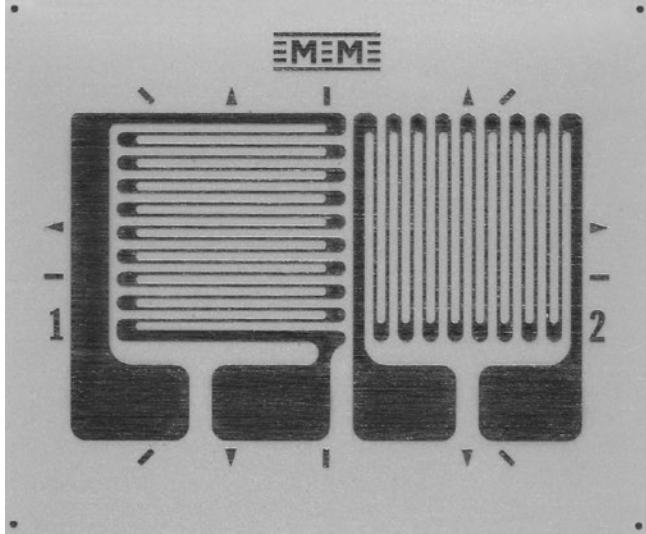
## General Purpose Strain Gages – Tee Rosette

GAGE PATTERN DATA							
			<b>GAGE DESIGNATION</b> See Note 1, 3	<b>RESISTANCE (OHMS)</b> See Note 2	<b>OPTIONS AVAILABLE</b> See Note 3		
			EA-XX-125TM-120 <b>WA-XX-125TM-120</b> WK-XX-125TM-350 EP-08-125TM-120 <b>SA-XX-125TM-120</b> <b>SK-XX-125TM-350</b>	120 ± 0.2% 120 ± 0.4% 350 ± 0.4% 120 ± 0.2% 120 ± 0.4% 350 ± 0.4%	W, E, L, LE W* <b>W*</b>		
 actual size			<b>DESCRIPTION</b> General-purpose two-element 90° tee rosette. Sections are electrically independent. See also 125TQ and 125UT patterns.				
<b>GAGE DIMENSIONS</b>		<b>Legend</b> ES = Each Section      CP = Complete Pattern S = Section (S1 = Section 1)      M = Matrix					
					<table border="1"> <tr><td>inch</td></tr> <tr><td>millimeter</td></tr> </table>	inch	millimeter
inch							
millimeter							
<b>Gage Length</b>	<b>Overall Length</b>	<b>Grid Width</b>	<b>Overall Width</b>	<b>Matrix Length</b>	<b>Matrix Width</b>		
0.125 ES	0.215 CP	0.150 ES	0.335 CP	0.36	0.43		
3.18 ES	5.46 CP	3.81 ES	8.51 CP	9.1	10.9		

<b>GAGE SERIES DATA</b> — See Gage Series datasheet for complete specifications			
Series	Description	Strain Range	Temperature Range
EA	Constantan foil in combination with a tough, flexible, polyimide backing.	±5%	-100° to +350°F (-75° to +175°C)
WA	Fully encapsulated constantan gages with high-endurance leadwires.	±2%	-100° to +400°F (-75° to +205°)
WK	Fully encapsulated K-alloy gages with high-endurance leadwires.	±1.5%	-452° to +550°F (-269° to +290°C)
EP	Annealed constantan foil with tough, high-elongation polyimide backing.	±20%	-100° to +400°F (-75° to +205°C)
SA	Fully encapsulated constantan gages with solder dots.	±2%	-100° to +400°F (-75° to +205°C)
SK	Fully encapsulated K-alloy gages with solder dots.	±1.5%	-452° to +450°F (-269° to +230°C)

**Note 1:** Insert desired S-T-C number in spaces marked XX.

**Note 2:** Tolerance is increased when Option W, E, SE, LE, or P is specified.

**Note 3:** Products with designations and options shown in **bold** are not RoHS compliant.

\*Options available but not normally recommended. See Optional Features datasheet for details.

## General Purpose Strain Gages – Tee Rosette

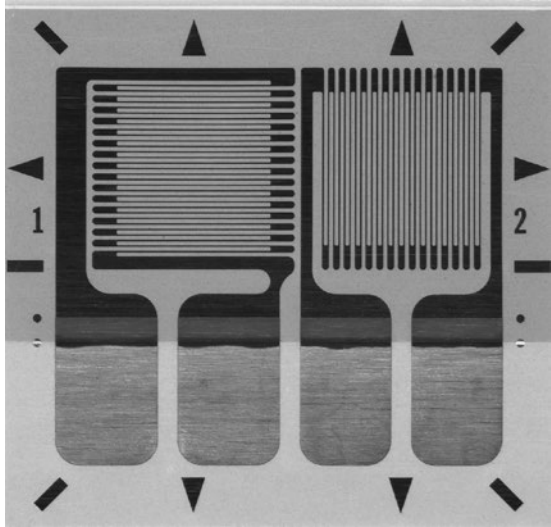

GAGE PATTERN DATA					
 <p style="text-align: center;">actual size</p>			<b>GAGE DESIGNATION</b> See Note 1	<b>RESISTANCE (OHMS)</b>	<b>OPTIONS AVAILABLE</b> See Note 1
			CEA-XX-125UT-120 CEA-XX-125UT-350	120 ± 0.4% 350 ± 0.4%	<b>P2</b> <b>P2</b>
<b>DESCRIPTION</b> Two-element 90° tee rosette for general-purpose use. Exposed solder tab area 0.10 x 0.07 in (2.5 x 1.8 mm).					
<b>GAGE DIMENSIONS</b>		<b>Legend</b>			<input type="checkbox"/> inch <input type="checkbox"/> millimeter
		ES = Each Section      CP = Complete Pattern S = Section (S1 = Section 1)      M = Matrix			
<b>Gage Length</b>	<b>Overall Length</b>	<b>Grid Width</b>	<b>Overall Width</b>	<b>Matrix Length</b>	<b>Matrix Width</b>
0.125 ES	0.325 CP	0.165 ES	0.365 CP	0.42	0.45
3.18 ES	8.26 CP	4.19 ES	9.27 CP	10.7	11.4

<b>GAGE SERIES DATA</b> — See Gage Series datasheet for complete specifications			
Series	Description	Strain Range	Temperature Range
CEA	Universal general-purpose strain gages.	±5%	-100° to +350°F (-75° to +175°C)

**Note 1:** Insert desired S-T-C number in spaces marked XX.

**Note 2:** Products with designations and options shown in bold are not RoHS compliant.

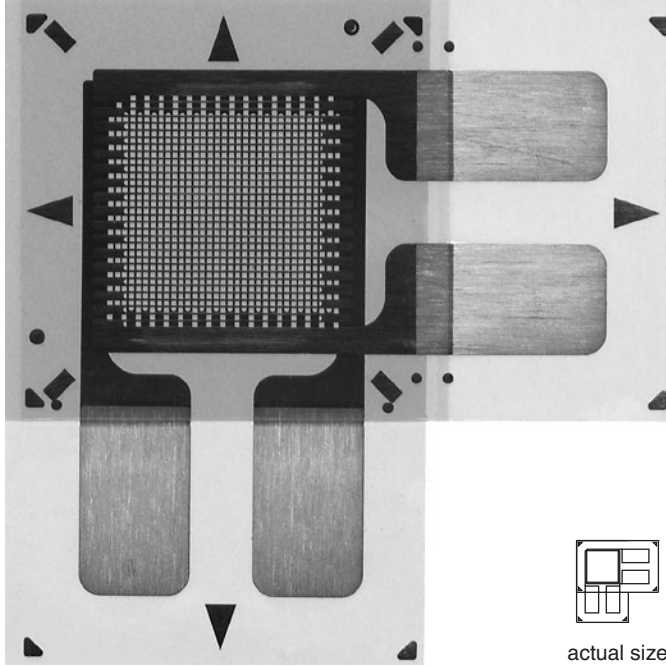
## General Purpose Strain Gages – Tee Rosette

GAGE PATTERN DATA					
  actual size			<b>GAGE DESIGNATION</b> See Note 1	<b>RESISTANCE (OHMS)</b>	<b>OPTIONS AVAILABLE</b>
			CEA-XX-125WT-120 CEA-XX-125WT-350	120 ± 0.5% 350 ± 0.5%	
<b>DESCRIPTION</b> Two-element 90° tee stacked rosette. Exposed solder tab area 0.10 x 0.07 in [2.5 x 1.8 mm]. Maximum operating temperature +150°F [+65°C].					 <b>RoHS COMPLIANT</b>
<b>GAGE DIMENSIONS</b>		<b>Legend</b> ES = Each Section      CP = Complete Pattern S = Section (S1 = Section 1)      M = Matrix			<input type="checkbox"/> inch <input type="checkbox"/> millimeter
<b>Gage Length</b>	<b>Overall Length</b>	<b>Grid Width</b>	<b>Overall Width</b>	<b>Matrix Length</b>	<b>Matrix Width</b>
0.125 ES	0.325 CP	0.180 ES	0.325 CP	0.42	0.42
3.18 ES	8.2 CP	4.57 ES	8.26 CP	10.7	10.7

GAGE SERIES DATA — See Gage Series datasheet for complete specifications			
Series	Description	Strain Range	Temperature Range
CEA	Universal general-purpose strain gages.	±3%	-100° to +150°F (-75° to +65°C)

**Note 1:** Insert desired S-T-C number in spaces marked XX.

## General Purpose Strain Gages – Tee Rosette

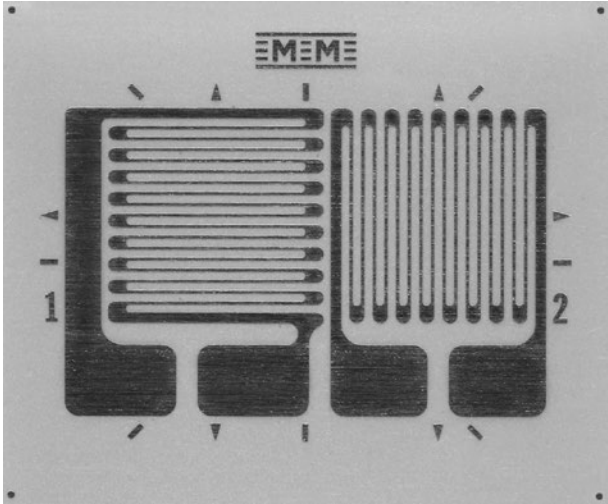
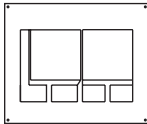
GAGE PATTERN DATA							
		<b>GAGE DESIGNATION</b> See Note 1, 3	<b>RESISTANCE (OHMS)</b> See Note 2	<b>OPTIONS AVAILABLE</b> See Note 3			
		EA-XX-125TM-120 <b>WA-XX-125TM-120</b> WK-XX-125TM-350 EP-08-125TM-120 <b>SA-XX-125TM-120</b> <b>SK-XX-125TM-350</b>	120 ± 0.2% 120 ± 0.4% 350 ± 0.4% 120 ± 0.2% 120 ± 0.4% 350 ± 0.4%	W, E, L, LE W* <b>W*</b>			
 <p>actual size</p>		<b>DESCRIPTION</b> General-purpose two-element 90° tee rosette. Sections are electrically independent. See also 250UT pattern.					
<b>GAGE DIMENSIONS</b>		<b>Legend</b> ES = Each Section S = Section (S1 = Section 1)			<table border="1"> <tr><td>inch</td></tr> <tr><td>millimeter</td></tr> </table>	inch	millimeter
inch							
millimeter							
<b>Gage Length</b>	<b>Overall Length</b>	<b>Grid Width</b>	<b>Overall Width</b>	<b>Matrix Length</b>	<b>Matrix Width</b>		
0.250 ES	0.430 CP	0.300 ES	0.670 CP	0.53	0.75		
6.35 ES	10.92 CP	7.62 ES	17.02 CP	13.5	19.1		

GAGE SERIES DATA — See Gage Series datasheet for complete specifications			
Series	Description	Strain Range	Temperature Range
EA	Constantan foil in combination with a tough, flexible, polyimide backing.	±5%	-100° to +350°F (-75° to +175°C)
WA	Fully encapsulated constantan gages with high-endurance leadwires.	±2%	-100° to +400°F (-75° to +205°)
WK	Fully encapsulated K-alloy gages with high-endurance leadwires.	±1.5%	-452° to +550°F (-269° to +290°C)
EP	Annealed constantan foil with tough, high-elongation polyimide backing.	±20%	-100° to +400°F (-75° to +205°C)
SA	Fully encapsulated constantan gages with solder dots.	±2%	-100° to +400°F (-75° to +205°C)
SK	Fully encapsulated K-alloy gages with solder dots.	±1.5%	-452° to +450°F (-269° to +230°C)

**Note 1:** Insert desired S-T-C number in spaces marked XX.

**Note 2:** Tolerance is increased when Option W, E, SE, LE, or P is specified.

**Note 3:** Products with designations and options shown in **bold** are not RoHS compliant.

\*Options available but not normally recommended. See Optional Features datasheet for details.

## General Purpose Strain Gages – Tee Rosette

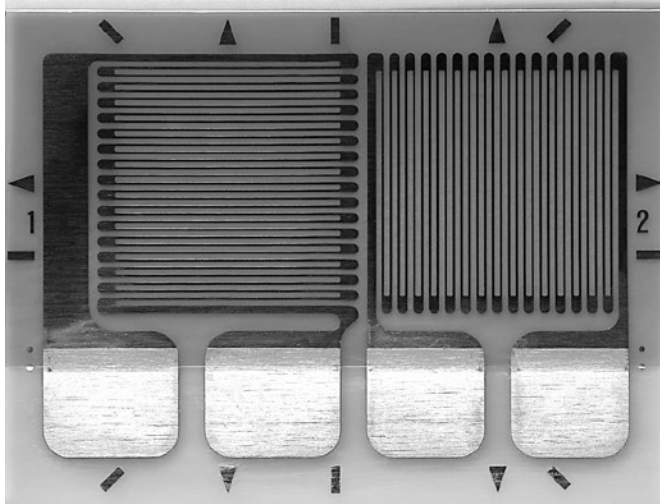
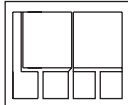
GAGE PATTERN DATA					
			<b>GAGE DESIGNATION</b> See Note 1, 3	<b>RESISTANCE (OHMS)</b> See Note 2	<b>OPTIONS AVAILABLE</b> See Note 3
			CEA-XX-250UT-120 CEA-XX-250UT-350 CEA-XX-250UT-10C	120 ± 0.4% 350 ± 0.4% 1000 ± 0.4%	<b>P2</b> <b>P2</b> <b>P2</b>
 actual size			<b>DESCRIPTION</b> Two-element 90° tee rosette for general-purpose use. Exposed solder tab area 0.13 x 0.10 in (3.3 x 2.5 mm).		
<b>GAGE DIMENSIONS</b>		<b>Legend</b> ES = Each Section      CP = Complete Pattern S = Section (S1 = Section 1)      M = Matrix			
				inch	
				millimeter	
<b>Gage Length</b>	<b>Overall Length</b>	<b>Grid Width</b>	<b>Overall Width</b>	<b>Matrix Length</b>	<b>Matrix Width</b>
0.250 ES	0.450 CP	0.290 ES	0.650 CP	0.55	0.74
6.35 ES	11.43 CP	7.37 ES	16.51 CP	14.0	18.8

GAGE SERIES DATA — See Gage Series datasheet for complete specifications			
Series	Description	Strain Range	Temperature Range
CEA	Universal general-purpose strain gages.	±5%	-100° to +350°F (-75° to +175°C)

**Note 1:** Insert desired S-T-C number in spaces marked XX.

**Note 2:** Products with designations and options shown in bold are not RoHS compliant.





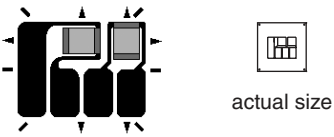
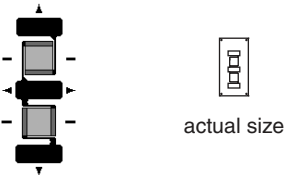
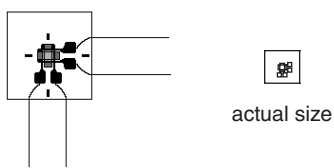
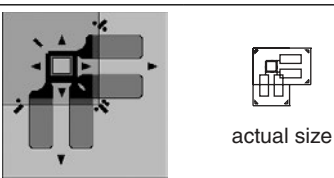
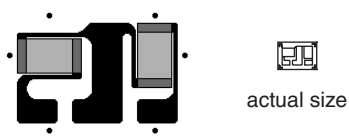
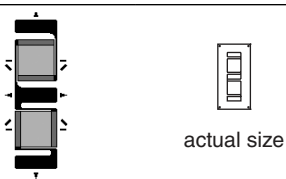







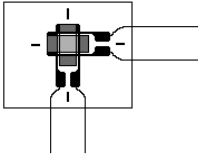

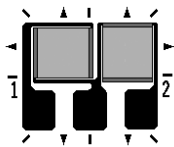
**General Purpose Strain Gages**

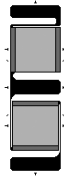
GAGE PATTERN	GAGE SERIES See Note 1	GAGE RESISTANCE (OHMS)	GAGE LENGTH	
			inches	millimeters
<b>030TU</b>  <p>actual size</p>	EA, EP, <b>SA, SK</b>	120, 350	0.03	0.76
	Miniature 90° tee rosette. Sections are electrically independent. Matrix size: 0.25L x 0.25W in. (6.4L x 6.4W mm)			
<b>030TY</b>  <p>actual size</p>	EA, EP, <b>SA, SK</b>	120, 350	0.03	0.76
	Miniature 90° tee rosette with large solder tabs. Matrix size: 0.30L x 0.15W in. (7.6L x 3.8W mm)			
<b>030WT</b>  <p>actual size</p>	<b>WA, WK, SA, SK</b>	120	0.03	0.76
	Miniature two-element 90° tee stacked rosette. See also 032WT pattern. Matrix size: 0.17L x 0.19W in. (4.3L x 4.8W mm)			
<b>032WT</b>  <p>actual size</p>	CEA	120	0.032	0.81
	Miniature two-element 90° stacked rosette. Exposed solder tab area is 0.07 x 0.04 in (1.8 x 1.0 mm). Maximum operating temperature +150°F (+65°C). Matrix size: 0.30L x 0.30W in. (7.6L x 7.6W mm)			
<b>044TP</b>  <p>actual size</p>	EA, <b>SA</b>	350	0.044	1.12
	Miniature high-resistance 90° tee rosette. Matrix size: 0.14L x 0.20W in. (3.6L x 5.1W mm)			
<b>050TG</b>  <p>actual size</p>	EA, <b>WA, EP, SA</b>	350	0.05	1.27
	Miniature high-resistance 90° tee rosette. Sections have a common solder tab. Matrix size: 0.34L x 0.17W in. (8.6L x 4.3W mm)			

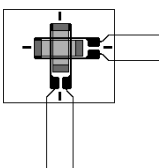
**Note 1:** Products with designations and options shown in **bold** are not RoHS compliant.

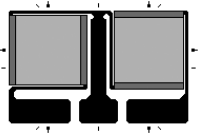
See <http://www.micro-measurements.com/stress-analysis-strain-gages/other-tee-rosettes/> for complete specifications.

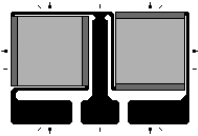
## General Purpose Strain Gages

GAGE PATTERN	GAGE SERIES See Note 1	GAGE RESISTANCE (OHMS)	GAGE LENGTH	
			inches	millimeters
<b>060WT</b>   <p>actual size</p>	<b>WA, WK, SA, SK</b>	120, 350, 1000	0.06	1.52
<p>Small two-element 90° tee stacked rosette. Matrix size: 0.24L x 0.30W in. (6.1L x 7.6W mm)</p>				
<b>062TZ</b>   <p>actual size</p>	<b>EA, WA, WK, SA, SK</b>	120, 350	0.062	1.57
<p>General-purpose 90° tee rosette. Matrix size: 0.28L x 0.26W in. (7.1L x 6.6W mm)</p>				
<b>100TG</b>   <p>actual size</p>	<b>EA, WA, SA</b>	350, 1000	0.1	2.54
<p>Small high-resistance 90° tee rosette for general-purpose use. Matrix size: 0.50L x 0.19W in. (12.7L x 4.8W mm)</p>				
<b>120WT</b>   <p>actual size</p>	<b>WA, WD, WK, SA, SK, SD</b>	120, 350	0.12	3.05
<p>Two-element 90° tee stacked rosette. Matrix size: 0.34L x 0.40W in. (8.6L x 10.2W mm)</p>				
<b>125TA</b>   <p>actual size</p>	<b>EA, WA, WK, SA, SK</b>	120, 350	0.125	3.18
<p>General-purpose two-element 90° tee rosette. Sections have a common electrical connection. See also 125TB pattern. Matrix size: 0.36L x 0.41W in. (9.1L x 10.4W mm)</p>				
<b>125TB</b>   <p>actual size</p>	<b>EA, EK, WA, WK, SA, SK</b>	350, 1000	0.125	3.18
<p>General-purpose two-element 90° tee rosette. Same geometry as 125TA but with higher resistance. Sections have common electrical connection. EK-Series gages are supplied with duplex copper dots (DD) when optional feature W or SE is not specified. Matrix size: 0.36L x 0.44W in. (9.1L x 11.2W mm)</p>				

**Note 1:** Products with designations and options shown in **bold** are not RoHS compliant.

See <http://www.micro-measurements.com/stress-analysis-strain-gages/other-tee-rosettes/> for complete specifications.

General Purpose Strain Gages

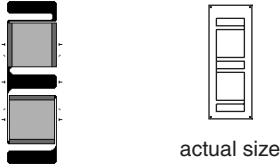
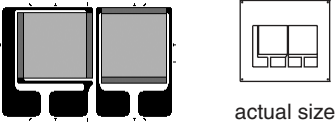
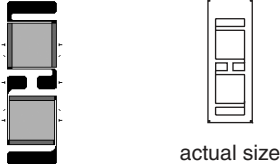
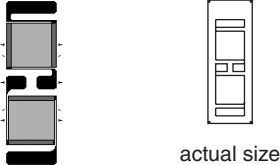
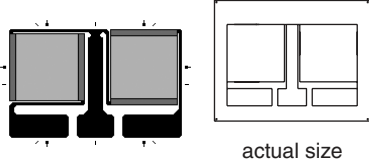
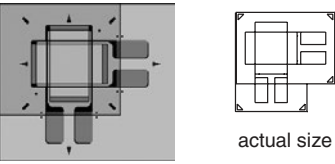
GAGE PATTERN	GAGE SERIES See Note 1	GAGE RESISTANCE (OHMS)	GAGE LENGTH	
			inches	millimeters
<b>125TF</b>  <p>actual size</p>	EA, <b>SA</b> , <b>SK</b>	120, 350	0.125	3.18
<p>General-purpose two-element 90° tee rosette with narrow pattern geometry. Sections have a common electrical connection.</p> <p>Matrix size: 0.59L x 0.21W in. (15.0L x 5.3W mm)</p>				
<b>125TQ</b>  <p>actual size</p>	EA, ED, <b>WA</b> , WK, EP, <b>SA</b> , <b>SK</b>	350, 1000	0.125	3.18
<p>General-purpose two-element 90° tee rosette. EK-Series gages are supplied with duplex copper dots (DD) when optional feature W or SE is not specified.</p> <p>Matrix size: 0.42L x 0.47W in. (10.7L x 11.9W mm)</p>				
<b>125VA</b>  <p>actual size</p>	EA, EP, <b>SA</b> , <b>SK</b>	350, 1000	0.125	3.18
<p>General-purpose two-element 90° tee rosette with high-resistance grid. See also 125VB pattern.</p> <p>Matrix size: 0.64L x 0.23W in. (16.3L x 5.8W mm)</p>				
<b>125VB</b>  <p>actual size</p>	EA, EP, <b>SA</b> , <b>SK</b>	120, 350	0.125	3.18
<p>General-purpose two-element 90° tee rosette. Similar to 125TF pattern except sections are electrically independent. See also 125VA pattern.</p> <p>Matrix size: 0.64L x 0.23W in. (16.3L x 5.8W mm)</p>				
<b>250TB</b>  <p>actual size</p>	EA, EK, <b>WA</b> , WK, <b>SA</b> , <b>SK</b>	350, 1000	0.25	6.35
<p>General-purpose two-element 90° tee rosette. EK-Series gages are supplied with duplex copper pads (DP) when optional feature W or SE is not specified.</p> <p>Matrix size: 0.63L x 0.81W in. (16.0L x 20.6W mm)</p>				
<b>250WQ</b>  <p>actual size</p>	CEA	350	0.25	6.35
<p>Two-element 90° tee stacked rosette. Maximum operating temperature +150°F (+65°C). Exposed solder tab area is 0.11 x 0.07 in (2.8 x 1.8 mm).</p> <p>Matrix size: 0.55L x 0.55W in. (14.0L x 14.0W mm)</p>				

**Note 1:** Products with designations and options shown in **bold** are not RoHS compliant.

See <http://www.micro-measurements.com/stress-analysis-strain-gages/other-tee-rosettes/> for complete specifications.

## General Purpose Strain Gages

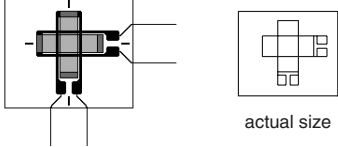
GAGE PATTERN	GAGE SERIES See Note 1	GAGE RESISTANCE (OHMS)	GAGE LENGTH	
			inches	millimeters
<b>250WT</b> 	<b>WA, WD, WK, SA, SK, SD</b>	120, 350	0.25	6.35
Two-element 90° tee stacked rosette. Matrix size: 0.51L x 0.60W in. (13.0L x 15.2W mm)				

**Note 1:** Products with designations and options shown in **bold** are not RoHS compliant.

See <http://www.micro-measurements.com/stress-analysis-strain-gages/other-tee-rosettes/> for complete specifications.