



I-Scan™

Product Selection Guide



TABLE OF CONTENTS

Overview 3

I-Scan System	3
Sensors	3

Tekscan Data Acquisition Electronics 4-12

Configurations	4
EVOLUTION™ STANDARD USB	5
VERSA TEK™ HIGH SPEED USB	6-7
WIRELESS VERSATEK WIRELESS UNIT	8-9
DATALOGGER VERSATEK DATALOGGER UNIT	10-11
Comparison Chart	12
Selection Guide	12

Software 13-16

Key Features	13
Graphing & Data Analysis	13
Sensor MAPs	14
Calibration	14
Visualization	15
Property Table	15
Export Functions	16

System Add-ons 17-21

Triggering & Synchronizing with External Devices	17
Analog Sensor Input to Tekscan Systems	18-19
Data Reader Toolkit	20
Pressure Mapping Software Development Kit (SDK)	21

Sensors 22-23

System Performance	22
Functionality	22
Specifications	23

Equilibration Devices 24-25

Contact Information 26

I-Scan System

This selection guide is designed to help you find the product that best suits your application. It provides detailed information and specifications on the various system options, features, and configurations.

I-Scan™ is a powerful tool that accurately measures and analyzes interface pressure between virtually any two surfaces, utilizing a thin and flexible sensor. The system is comprised of data acquisition electronics, sensors, and software. There are many different options for data acquisition electronics, standard and custom sensors, and software add-ons, which make the I-Scan system extremely versatile, creating endless possibilities for applications.

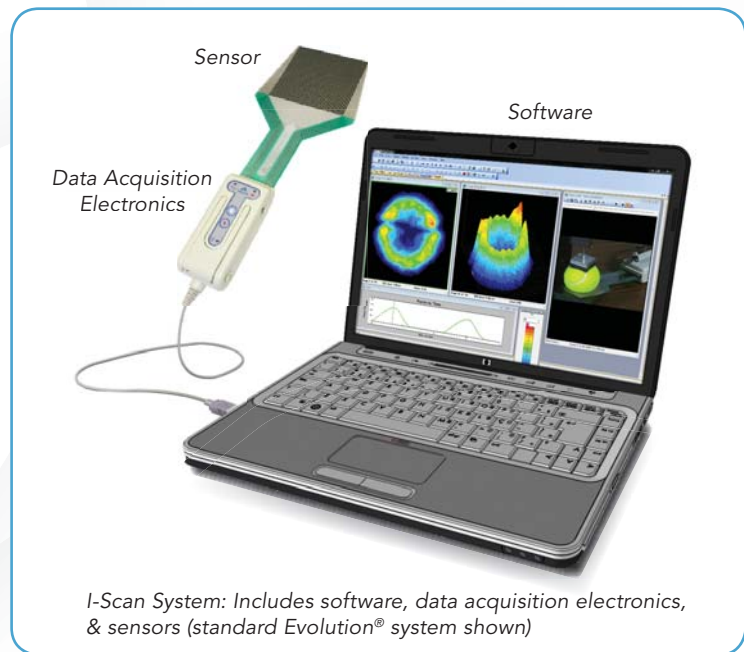

Sensors

Over 200 flexible, thin film sensors are available in different sizes, shapes, resolutions, temperature ratings, and pressure ranges (up to 25,000 psi or 1,700 bar).

- High spatial resolution:
 - Up to 248 sensing elements/cm² (1,600 sensing elements/in²)
 - Sensing elements with as narrow as 0.1 mm (0.02 in.) spacing
- Sensing area ranging from 3 mm x 3 mm (.12 in. x .12 in.) up to 1,734 mm x 1,768 mm (68 in. x 69 in.)
- Optional high-temp sensors can withstand up to 200°C (392°F)
- Large high resolution sensors with multiple tabs require cross handle scanning. This requires VersaTek electronics, capable of having multiple handles coordinated in scanning the sensing area
- Fully customized sensors can be manufactured

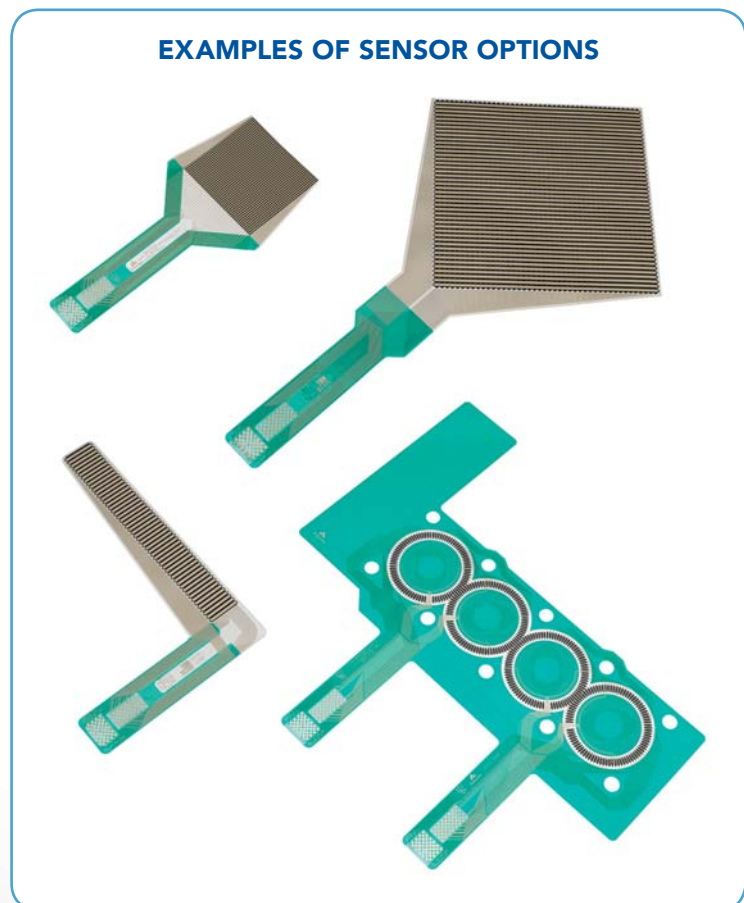

TEKSCAN DATA ACQUISITION ELECTRONICS

Tekscan's products function in both static and dynamic measurement environments. In order to obtain the pressure data from the sensor, data acquisition electronics scan the sensing elements within each sensor. The data is instantly relayed to the software on a PC via USB cable. Sensors can be scanned at up to 1,600,000 sensing elements/second.

The 5051, a common Tekscan sensor with just under 2000 sensing elements has a maximum scanning speed of 100 Hz with all electronics.

High speed sensors with 44 sensing elements can be fully scanned with VersaTek electronics at 20 kHz.

Configurations

To best suit your application, I-Scan offers different options for data acquisition electronics:

Evolution™

STANDARD USB
Up to 100 Hz

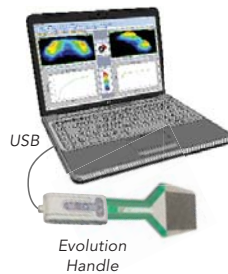

For use in standard applications.

VersaTek™

HIGH SPEED USB
Up to 20 kHz



For use in high-speed applications or for sensors with higher resolution over large areas.

Wireless

VERSATEK® WIRELESS UNIT
Up to 4,600 Hz



Wirelessly transmit data to PC for remote data collection (up to 100m).

Datalogger

VERSATEK® DATALOGGER UNIT
Up to 20 kHz



Collect data onto Datalogger Unit and upload to PC after data collection. For wireless use at higher speeds & noisy environments.

Evolution™ Standard USB

Used for standard applications, this system is lightweight and versatile. The Evolution scanning electronics consist of a handle that connects to a sensor and to the USB port of a PC. Multiple handles may be used simultaneously. Indicators on the handle show system status and allow some control of data collection.

Evolution Handle	
System Part #	IE1
Physical Characteristics	
Housing Material	Polycarbonate/ABS blend (Beige)
Size L x W x H	137.9 mm x 57.2 mm x 33.5 mm (5.43 in. x 2.25 in. x 1.32 in.)
Connection Type	USB 2.0
Weight	305 g (10.8 oz)
Power Source	USB Powered, 200mA, 1W
Standard Cable Length	4.57 m (15 ft)
Operating Characteristics	
Maximum Scanning Speed	Up to 100 Hz (speeds vary by sensor)
Pulse-Per-Frame Synchronization	No
Digital Pressure Resolution	8 Bit
Communication to PC	USB 2.0, 480 Mbps
Voltage: Current Consumption	200 mA, 1 W
Sensitivity Adjustment	x 3 to 1/7 of Sensor Pressure Rating
Operating Conditions	
Temperature	-20°C to 35°C (-4°F to 95°F)
Relative Humidity (%)	5-90 (non-condensing)
System Components (Part #)	
Evolution Handle (EH-2), System Carrying Case, Sensor Carrying Case, System Manual	

- Handle powered directly from PC via USB cable
- Up to 100 Hz scanning speed (speed varies by sensor)

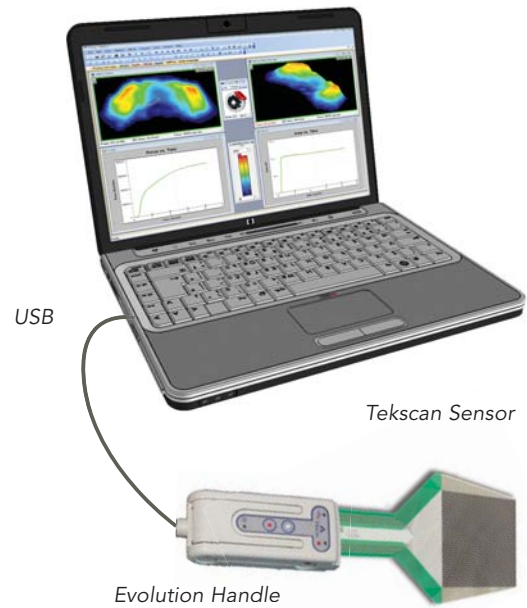

Evolution Handle Dimensions (mm)

Top View

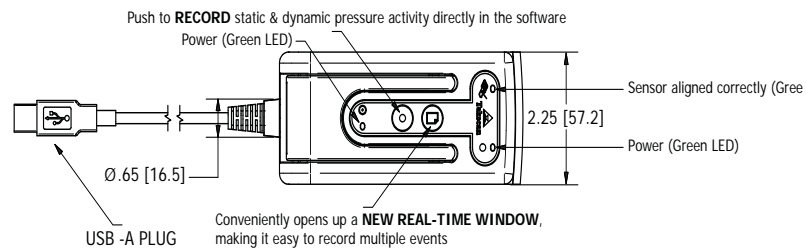

Side View

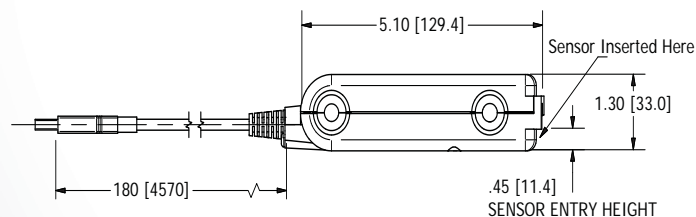

Bottom View

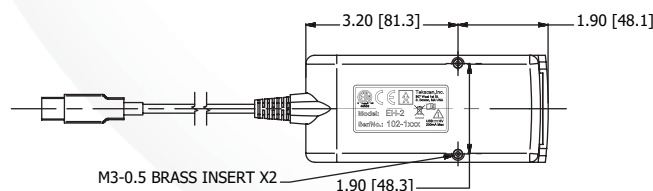

VersaTek™ High Speed USB

Used for larger sensors with multiple tabs or high speed applications. The VersaTek scanning electronics consist of a handle and an 8-port hub. The handle connects to a sensor, and the hub joins the handle to your PC via USB connections. The hub drives and collects signals from up to 8 handles simultaneously.

VersaTek Handle & 8-Port Hub	
System Part #	IVB1
Physical Characteristics	
Housing Material	Handle: Polycarbonate/ABS blend (Grey) Hub: Polyurethane [PUR] (Grey)
Connection Type	USB 2.0
Weight	Handle: 305 g (10.8 oz) Hub: 370 g (13.1 oz)
Power Source	Input: 100-240V 5A 50-60 Hz, 1.2A Output: 12V, 5A
Standard Cable Length	Handle to Hub: 4.57 m (15 ft) Hub to Host: 3 m (10 ft)
Maximum Cable Length	Handle to Hub: 30 m (100 ft) Hub to PC: 5 m (16.4 ft)
Operating Characteristics	
Maximum Scanning Speed	Up to 20 kHz (speeds vary by sensor)
Handles Supported by Hub	8
Pulse-Per-Frame Synchronization	Yes
Digital Pressure Resolution	8 Bit
Communication to PC	USB 2.0, 480 Mbps
Sensitivity Adjustment	x 7 to 1/3 of Sensor Pressure Rating
Operating Conditions	
Temperature	-10°C to 55°C (14°F to 131°F)
Relative Humidity (%)	0 to 90 (non condensing)
System Components (Part #)	
VersaTek Handle (VH-1), VersaTek 8-Port Hub (V8PH-1), Power Supply (VPS-2), AC Cord (CAB-SJ120-8), 10 foot USB-A to USB-B Cable, System Carrying Case, Sensor Carrying Case, System Manual	

- Up to 20 kHz scanning speed
- BNC in/out ports for trigger & synchronization
- Up to 8 handles simultaneously collecting data:
 - Multiple Sensors
 - 1 Large sensor with multiple handles

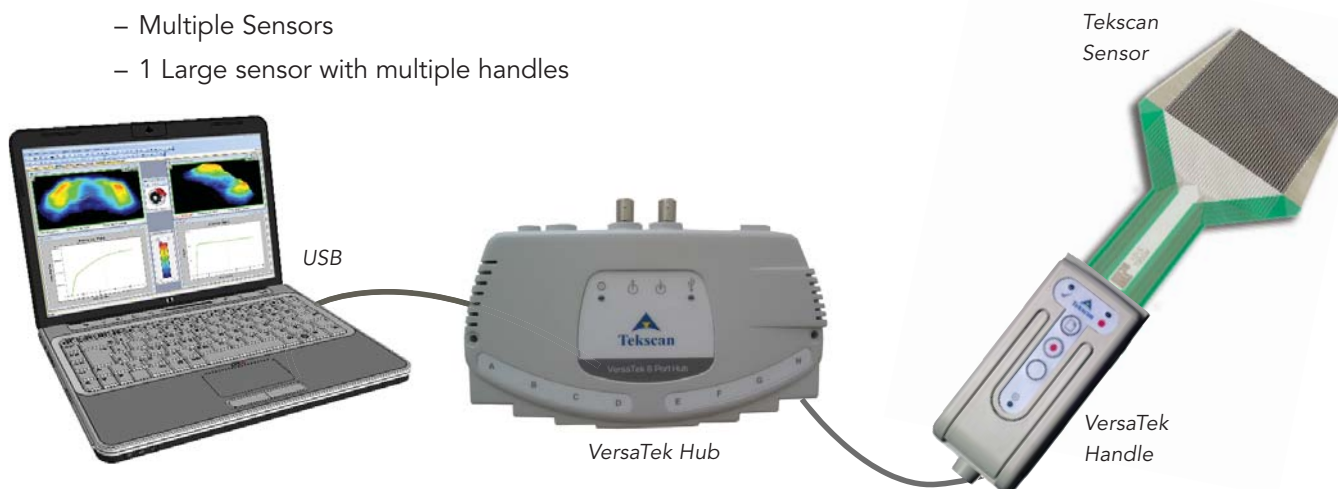

Wireless VersaTek Wireless Unit

Ideal for applications where the object being measured is in motion or involves a hazardous area or materials. Scanning electronics consist of a VersaTek handle, Wireless Unit, and a preconfigured wireless router. A sensor connects to the handle, and the handle connects to the Wireless Unit via CAT5E cable. The unit transmits data wirelessly to the routers network, which is connected to your PC for remote data collection (up to 100 m) *Note: for configuration, the Wireless Unit connects to your PC via USB.*

Wireless Unit	
Model #	IVW
Physical Characteristics	
Housing Material	Handle: Polycarbonate/ABS blend (Grey) Wireless Unit: Polycarbonate/ABS blend (Grey) Wireless unit mounting fixture: Polyurethane [PUR] (Black)
Connection Type	802.11B wireless
Weight	24 oz (665 g)
Power Source	Li-Ion Battery: 8V / 2.4 Ah or Power supply: 100-240V, 5A
Standard Cable Length	Handle to Unit: 4.57 m (15 ft)
Maximum Cable Length	30 m (100 ft)
Operating Characteristics	
Maximum Scanning Speed	Up to 4,600 Hz (speeds vary by sensor)
Handles Supported by Hub	2
Pulse-Per-Frame Synchronization	Yes
Digital Pressure Resolution	8 Bit
Communication to PC	802.11B wireless via PC wireless card or provided USB to wireless adapter
Sensitivity Adjustment	x 7 to 1/3 of Sensor Pressure Rating
Battery Life	2 Hours of continuous operation
Operating Conditions	
Temperature	-20 to 35° C (-4 to 95°F)
Relative Humidity (%)	5 to 90 (Non-Condensing)
System Components (Part #)	
VersaTek Handle (VH-1), Wireless Hub with mounting fixture, preconfigured wireless router (AVW-WR), Power Supply (VPS-1), AC Cord (CAB-SJ120-8), Li-Ion battery (VWD-A-BP), Battery Charger (VCH-1), Battery Charger Power Supply (VPS-3), Cable Ferrites (VWD-A-LF), 6 foot USB-A to Mini-B Cable, System Carrying Case, Sensor Carrying Case, System Manual	

- Wireless range up to 100 meters
- Real-time data and movie recording
- Wireless signal strength indication and automatic buffering if wireless unit moves out of range
- Scan up to two handles simultaneously
- Same unit also available with both Wireless and Datalogger capabilities



Preconfigured
Wireless Router



Wireless Unit



VersaTek
Handle

VersaTek Handle Dimensions (mm)

Top View

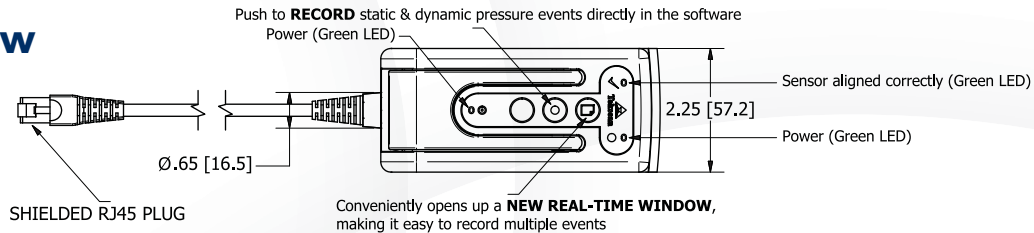

Side View

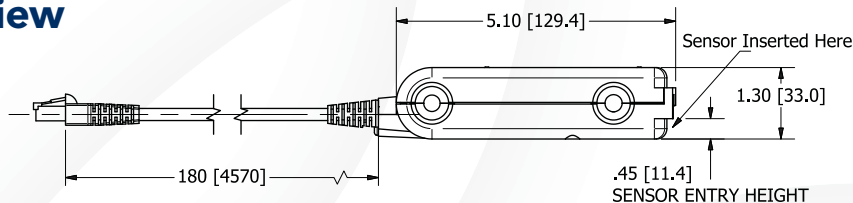

Bottom View

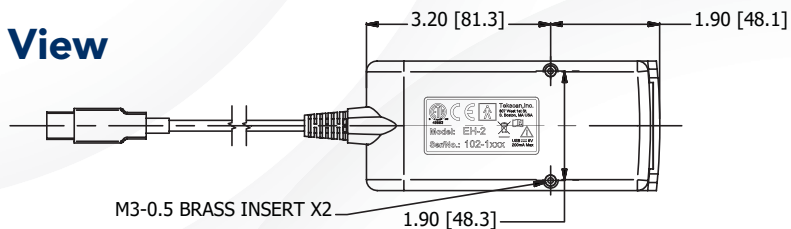

Wireless Unit Dimensions (mm)

Top View

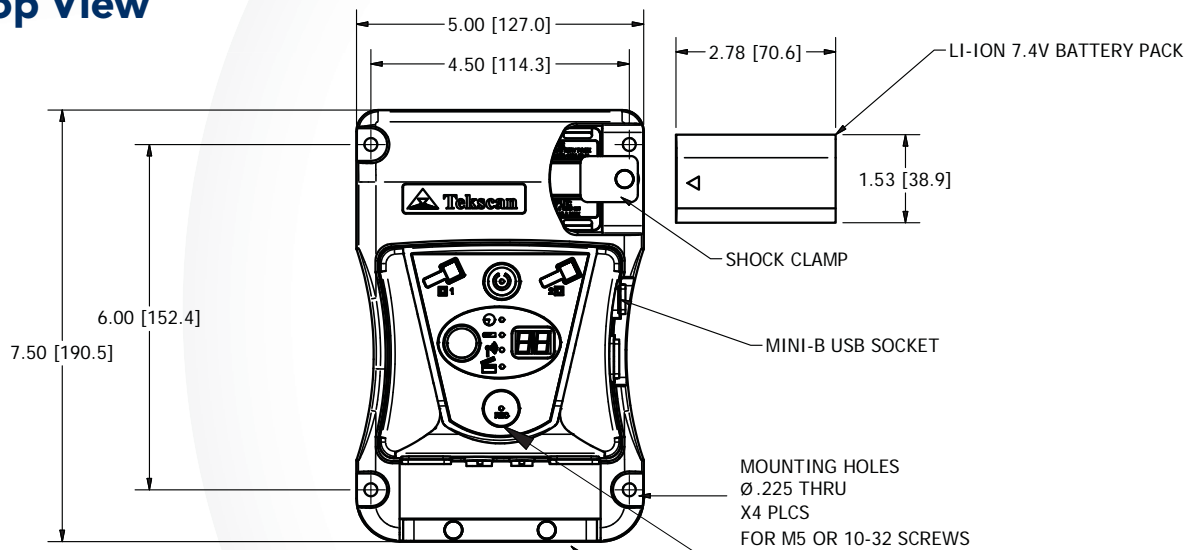

Side View

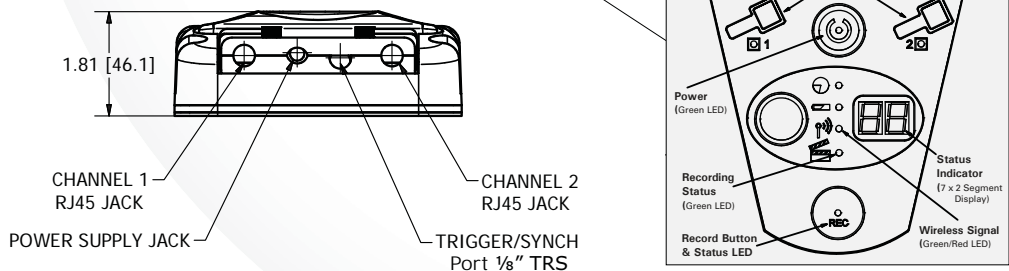

Datalogger VersaTek Datalogger Unit

For wireless use at higher speeds and in environments that are noisy (not “wireless friendly”). Ideal system for when recordings need to be made over an extended period of time or if the target needs to travel from the PC. The scanning electronics consist of a VersaTek handle and Datalogger Unit. A sensor connects to the handle, and the handle connects to the Datalogger Unit via CAT5E cable. The Datalogger Unit collects and stores data in its internal memory for upload to a PC at a later time. *Note: for configuration, the Wireless Unit connects to your PC via USB.*

Datalogger Unit	
Model #	IVD
Physical Characteristics	
Housing Material	Handle: Polycarbonate/ABS blend (Grey) Wireless Unit: Polycarbonate/ABS blend (Grey) Datalogger unit mounting fixture: Polyurethane [PUR] (Black)
Connection Type	8GB USB 2.0 Micro SD card
Weight	24 oz (665 g)
Power Source	Li-Ion Battery: 8V / 2.4 Ah or Power supply: 100-240V, 5A
Standard Cable Length	Handle to Unit: 4.57 m (15 ft)
Maximum Cable Length	30 m (100 ft)
Operating Characteristics	
Maximum Scanning Speed	Up to 20 kHz (speeds vary by sensor)
Handles Supported by Hub	2
Pulse-Per-Frame Synchronization	Yes
Digital Pressure Resolution	8 Bit
Communication to PC	8GB Micro SD card (directly or though USB 2.0 cable connected to Datalogger unit)
Sensitivity Adjustment	x 7 to 1/3 of Sensor Pressure Rating
Battery Life	2 Hours of continuous operation
Operating Conditions	
Temperature	-20 to 35° C (-4 to 95°F)
Relative Humidity (%)	5 to 90 (Non-Condensing)
System Components (Part #)	
VersaTek Handle (VH-1), Datalogger Hub with mounting fixture, Formatted USB Memory Stick (VWD-A-MS), Power Supply (VPS-1), AC Cord (CAB-SJ120-8), Li-Ion battery (VWD-A-BP), Battery Charger (VCH-1), Battery Charger Power Supply (VPS-3), Cable Ferrites (VWD-A-LF), 6 foot USB-A to Mini-B Cable, System Carrying Case, Sensor Carrying Case, System Manual	

- Up to 20 kHz scanning speed
- Data is saved directly to the included 8 GB Micro SD card
- Simultaneously record up to two handles
- Same unit also available with both Wireless and Datalogger capabilities

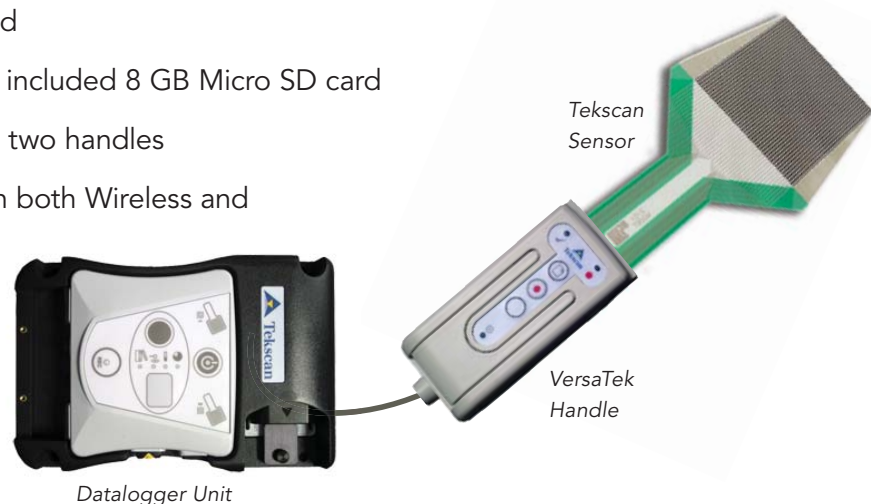

VersaTek Handle Dimensions (mm)

Top View

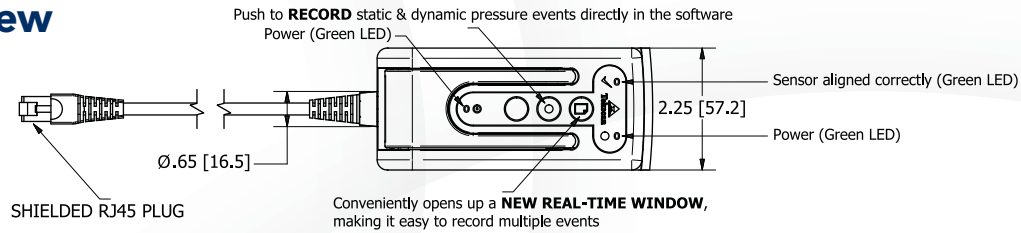

Side View

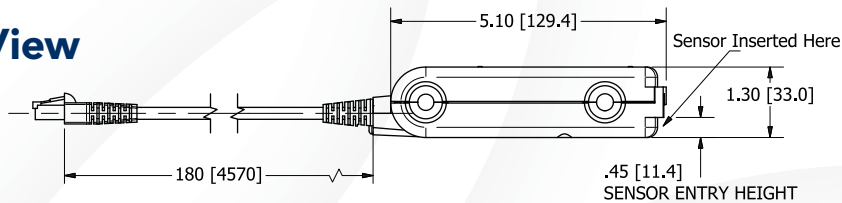

Bottom View

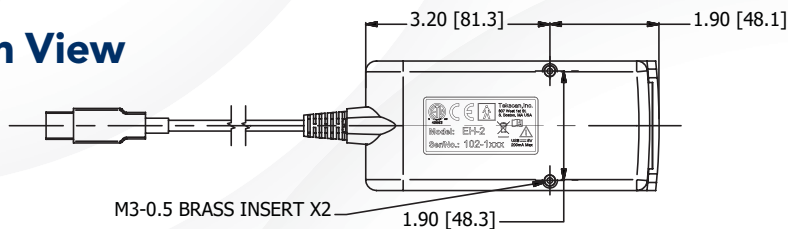

Datalogger Unit Dimensions (mm)

Top View

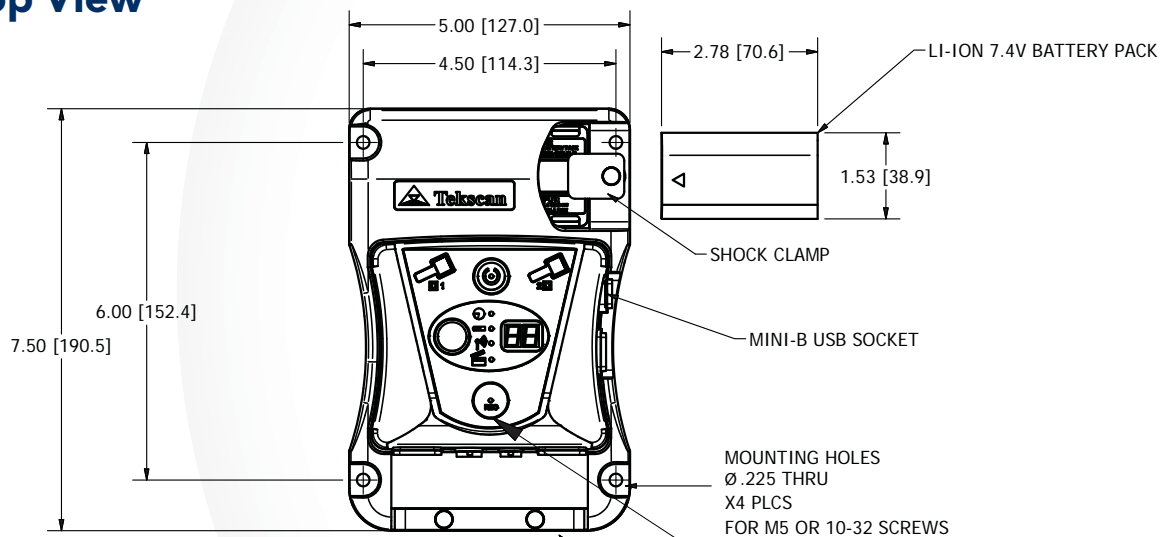

Side View

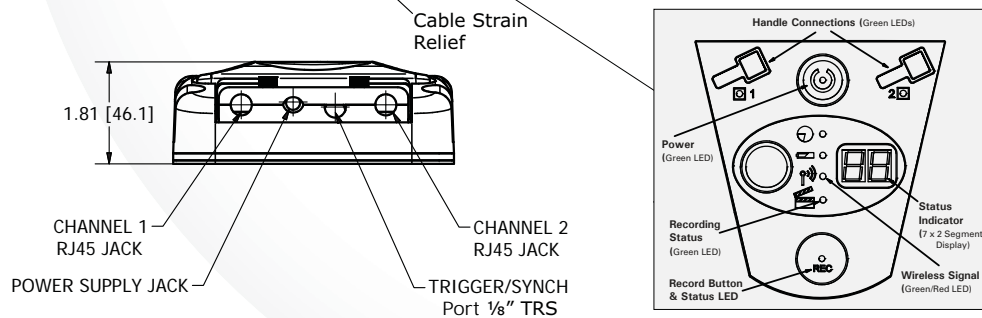

Comparison Chart

	Evolution (Standard USB)	VersaTek (High Speed USB)	Wireless (VersaTek Wireless Unit)	Datalogger (VersaTek Datalogger)
Data Acquisition Electronics	• Evolution Handle	• VersaTek Handle • VersaTek Hub	• VersaTek Handle • Wireless Unit	• VersaTek Handle • Datalogger Unit
Maximum Scanning Speed	100 Hz	20 kHz	4,600 Hz	20 kHz
Cross Handle Scanning	No	Up to 8	Up to 2	Up to 2
Pulse-Per-Frame Synchronization	No	in & out	in & out	in & out
Adjustable Sensitivity	x 3 to 1/7 of Sensor Pressure Rating	x 7 to 1/3 of Sensor Pressure Rating	x 7 to 1/3 of Sensor Pressure Rating	x 7 to 1/3 of Sensor Pressure Rating
Power Source	USB Port of PC	100-240V Power Supply	Li-Ion Battery: 8V / 2.4 Ah or Power supply: 100-240V, 5A	Li-Ion Battery: 8V / 2.4 Ah or Power supply: 100-240V, 5A
Maximum Handle Cable Length	5.0 m (16.4 ft)	30.48 m (100 ft)	30.48 m (100 ft)	30.48 m (100 ft)
Maximum Hub Cable Length	n/a	5.0 m (16.4 ft)	5.0 m (16.4 ft)	5.0 m (16.4 ft)

Selection Guide

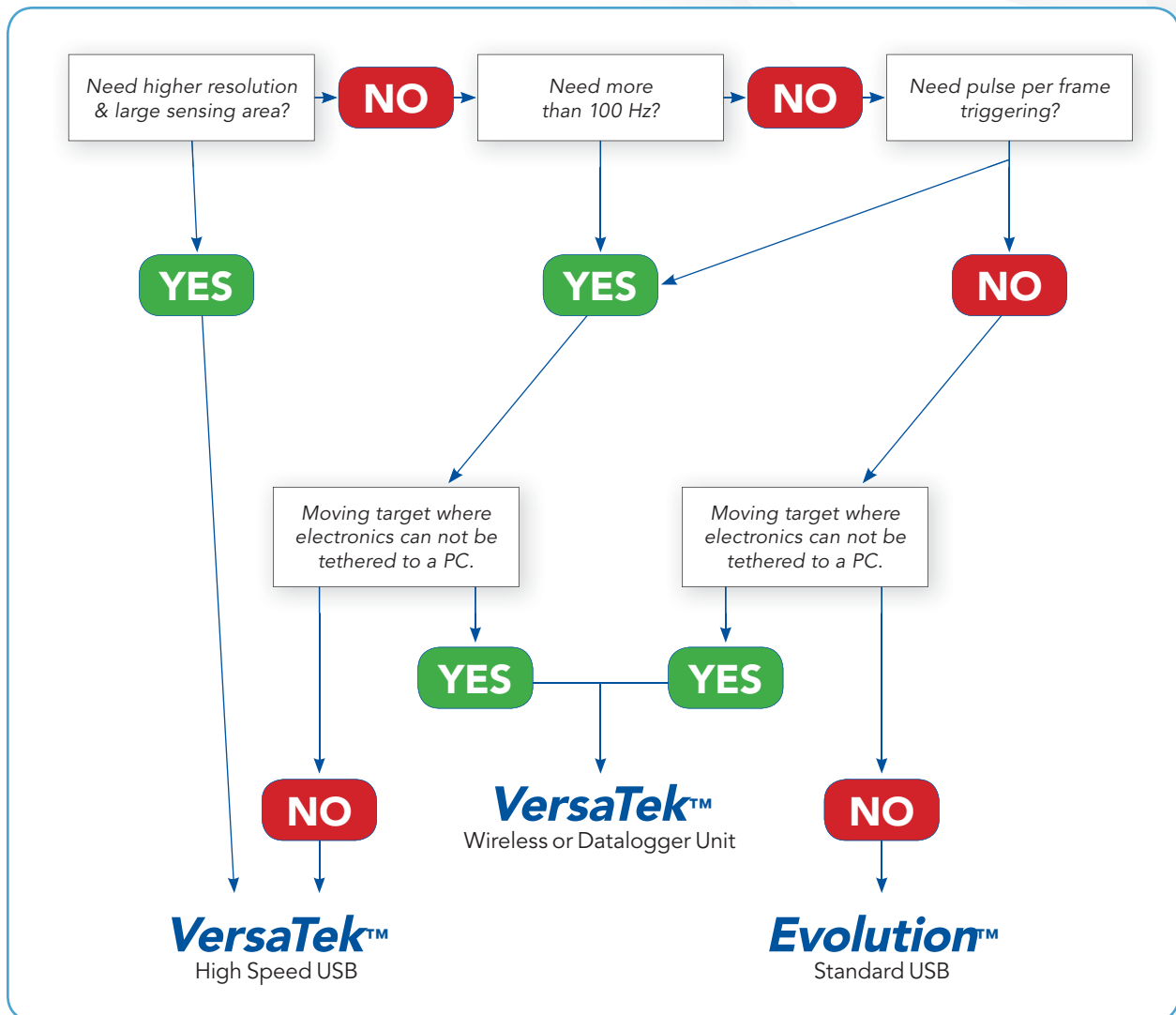

I-Scan's intuitive software displays pressure data in real time with the ability to record, save, and play back recording files (.fsx), or export as an ASCII text file (.csv) for use with other programs.

Key Features

- 2D, 3D, and contour pressure image views
- Real-time sensor data viewing
- Pressure Data Snapshots
- Record pressure data over time
- Play back pressure movies
- Graphical analysis of real time or stored data
- Pressure displayed in Engineering or Relative units
- Single & Multi-point calibration
- Single & Multi-point equilibration
- Peak pressure views
- ASCII export capability
- Save as AVI
- Scan rate of up to 20 kHz

Graphic & Data Analysis

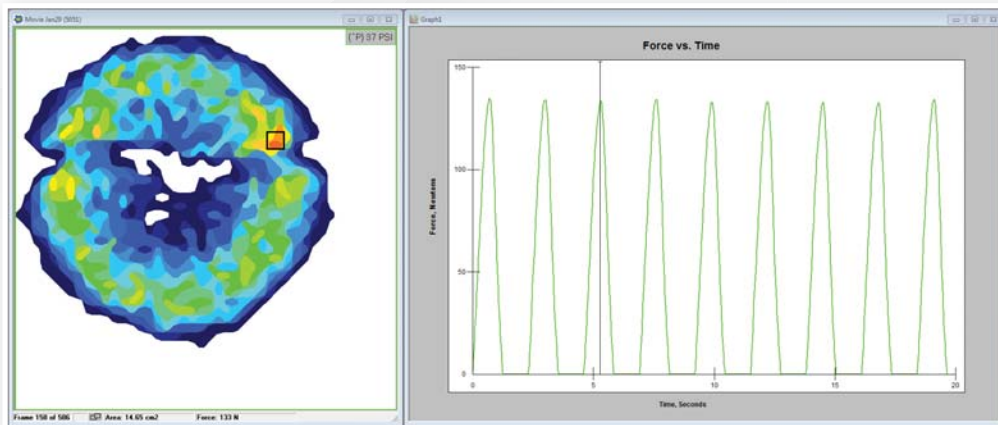

Force vs. time graph – the cursor at 3 seconds correlates to the pressure output on the left. Users can click any point in time along the x-axis to view the resulting pressure output image.

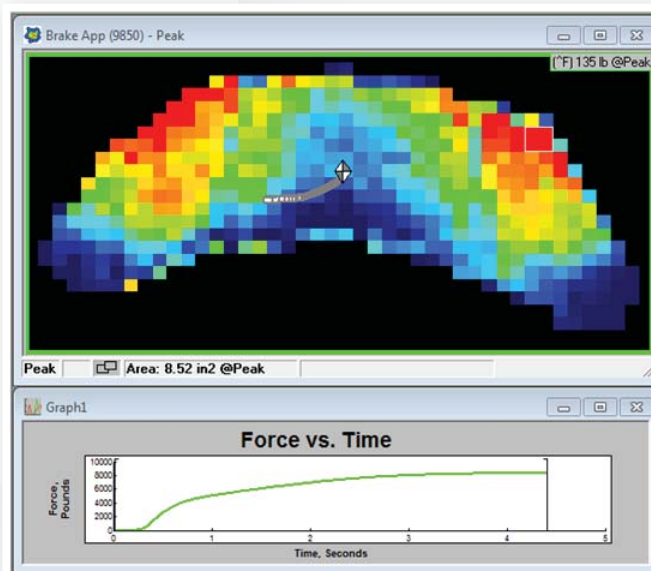

Data available from each frame:

- Total Force
- Center of Force location
- Peak Pressure
- Pressure distribution (i.e. force on each sensing element)

Sensor MAPs

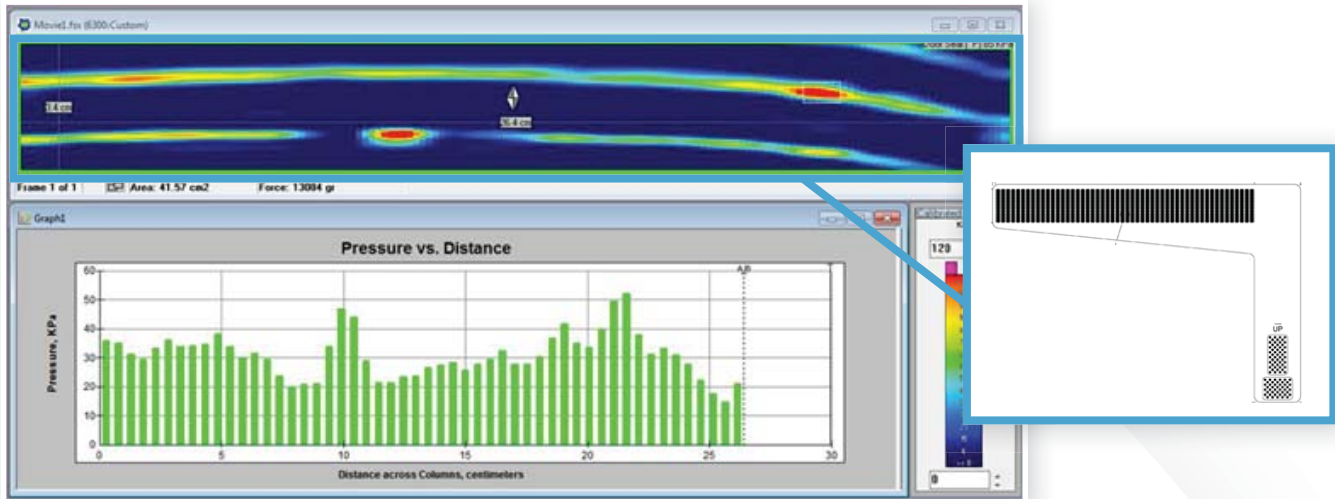

Each sensor requires its own unique MAP driver file for the software to function properly. By utilizing sensor MAPs, the software is able to provide an accurate depiction of each unique sensor layout. The sensor MAP controls the shape of the pressure image window in the software, which corresponds to the shape and dimensions of the sensing area on the sensor.

Calibration

Multipoint calibration window

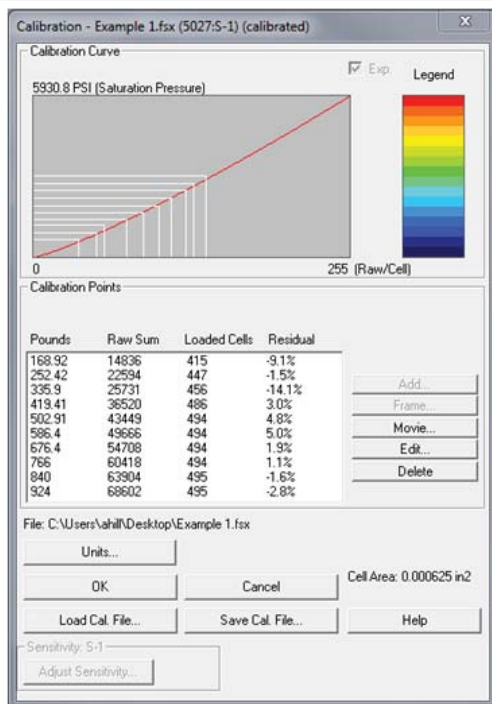

With a controlled load, up to 10 calibration points can be set in the software to apply units to the measurement values

Movie calibration window

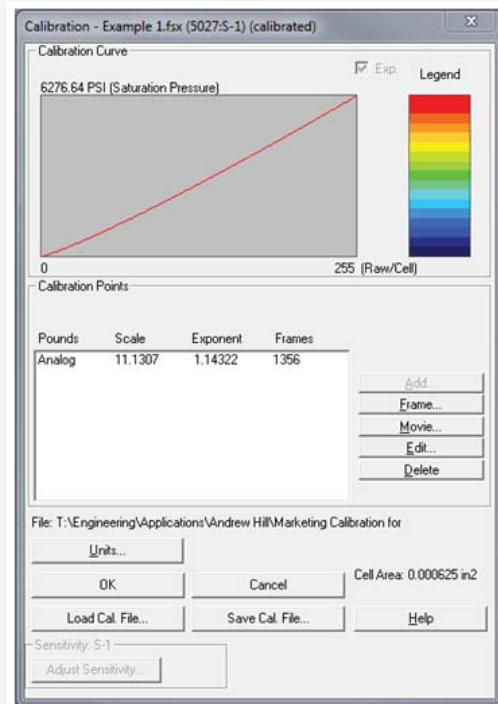

When utilizing the analog input capabilities of Tekscan software, a movie can automatically be calibrated using a load cell connected to the system

Visualization

Realistic Data Representation:

- Optimized 2D display algorithms in the software interpolate sensor data to smooth pressure map display; giving a more realistic representation of the object being measured
- Select among three Interpolation views: 1x1, 3x3, and 5x5

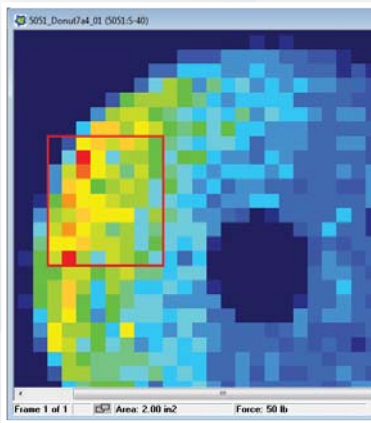
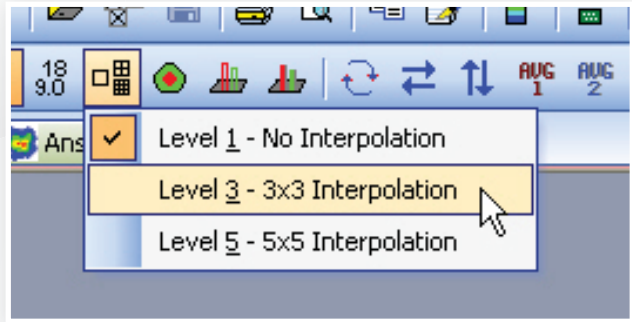

1 x 1 No Interpolation

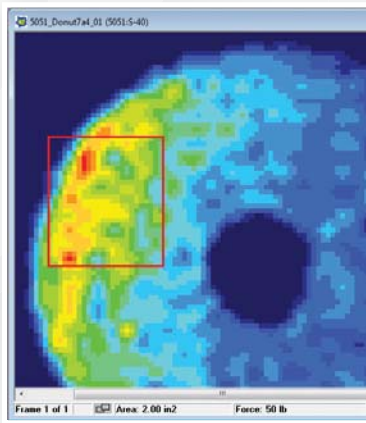

3 x 3 Interpolation

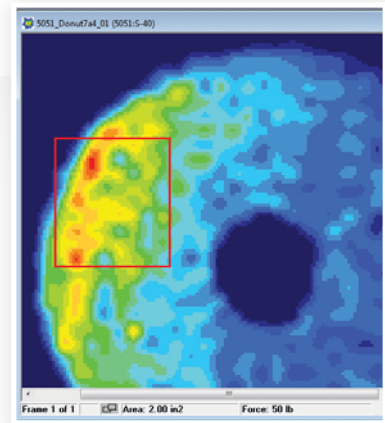

5 x 5 Interpolation

Property Table

I-Scan includes the new Property Table. The Property Table makes it easier to access sensor data by allowing you to view data as an integrated Microsoft Excel table*. Data can be viewed and graphed within a single Excel spreadsheet from within the Tekscan software. Formulas can be added to the table, providing application specific values. Customize Excel calculations, sort, and format from directly inside the Tekscan software.

	S051_Donus7a4_01 (S051:5-40)				S051_HotSpotDonus7a4_01			
1	Frame	1			1			
2	Time	0			0			
3	Force	50	34	16	Pounds	30	31	29
4	Object Area	4.94	2.42	2.42	m2	4.84	2.42	2.42
5	Contact Area	2	1.01	0.99	m2	1.93	0.98	0.95
6	Object Pressure	10	14	7	PSI	10	13	6
7	Contact Pressure	25	34	16	PSI	36	30	21
8	Peak Force	1	1	0	Pounds	2	1	1
9	Peak Object Pressure	70	70	36	PSI	134	134	121
10	Peak Contact Pressure	70	70	36	PSI	134	134	121
11	COF-Row	21.45	21.43	21.48	Row	34	21.45	24.58
12	COF-Col	18.39	18.65	28.53	Col	19.37	18.15	28.01

Create custom formulas and calculations

Compare multiple movies simultaneously

Table cells are color coordinated with shapes on the data's image.

Excel Interface - All Excel toolbar and menu items become accessible in I-Scan toolbar

Data in the graph corresponds to data in the Property Table

Excel Table can be edited directly within I-Scan (the table is an embedded object inside the Tekscan software window)

*(Requires Excel 2000 or newer)

Triggering & Synchronizing with External Devices

The External Trigger Synch software add-on feature enables users to configure a variety of system triggering capabilities of the Tekscan scanning electronics. Using Tekscan software, systems can be configured as a slave (to respond to an external signal) or as a master (to send a signal to an external device).

Applications

- Synchronizing Tekscan data with video recordings
- Triggering a Tekscan recording via a signal from an external device
- Triggering and synchronizing a Tekscan system with a 3rd party product, such as a motion capture or an EMG system

Possible Configurations

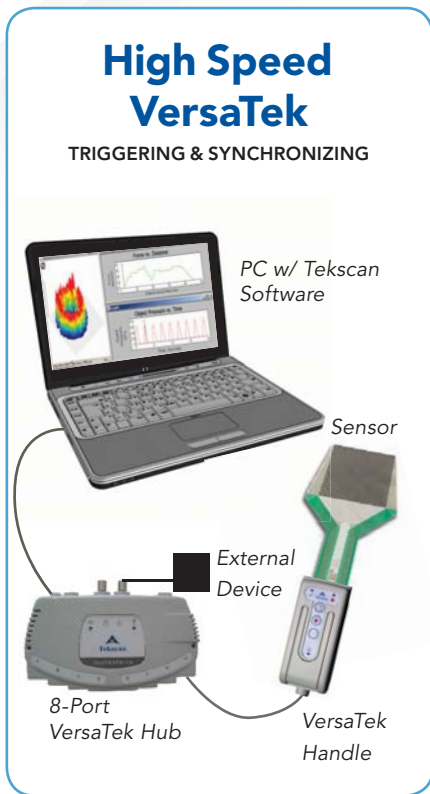
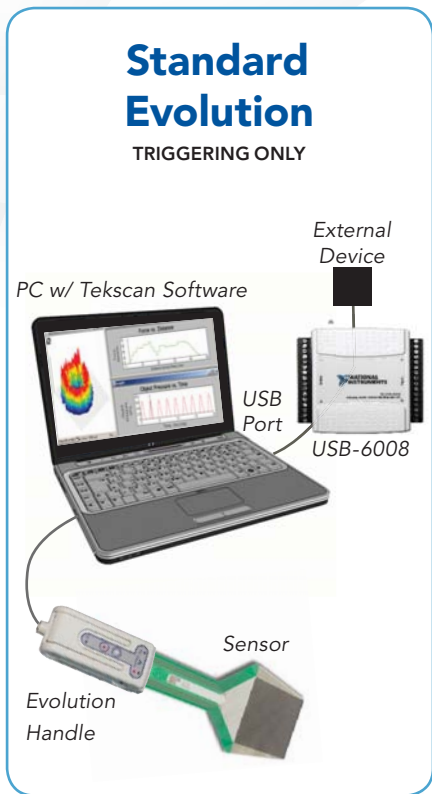

Tekscan systems can be configured as slave or master.

Requirements	Trigger Modes		
<ul style="list-style-type: none"> • For trigger input: Triggering device providing a contact closure signal • For trigger output & synchronization: Connection is 3.3V CMOS / 5 V TTL logic level compatible • Trigger Synch software is an add-on for the following Tekscan systems: I-Scan or TireScan 	Synchronization	Pulse-per-Frame (VersaTek only)	
	Triggering	Rising Edge	
		Falling Edge	

Analog Sensor Input to Tekscan Systems

Two analog to digital device options are available to integrate analog signals with Tekscan systems via USB:

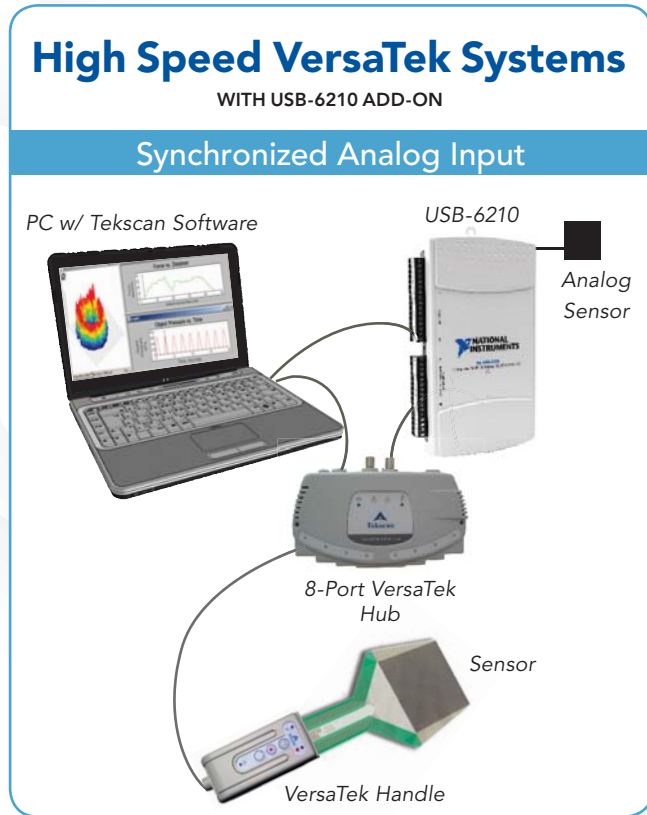
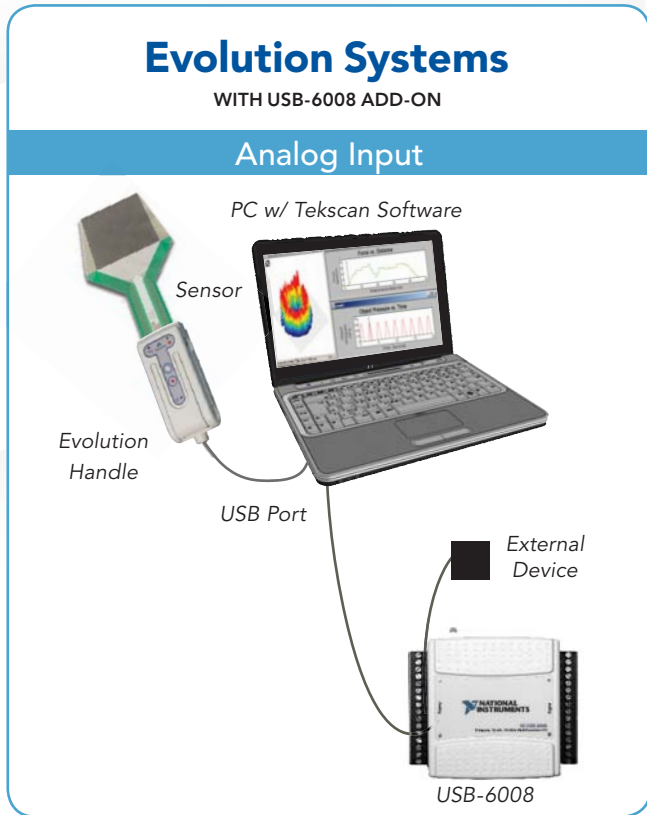

USB-6008

- Analog input (up to 100 Hz)
- Calibration with load cell (up to 100 Hz)

Note: Can also be used with VersaTek Hubs in low speed applications (up to 100 Hz) .

Analog Sensor Input

All Tekscan systems can record up to eight analog sensors in addition to acquiring pressure data from the Tekscan sensor. In-depth analysis can be run while correlating Tekscan data with data from:

- Thermocouples
- Load cells
- Humidity sensors
- Other analog output sensors

USB-6210

- Analog input (up to 20 kHz)
- Calibration with load cell (up to 20 kHz)
- Synchronize data collection between analog and tactile sensor in high speed applications (ideal for impact studies)

Calibration

If a load cell is connected to the analog input device, the simultaneous measurements of the load cell and the Tekscan sensor can be used to increase the accuracy of sensor calibration.

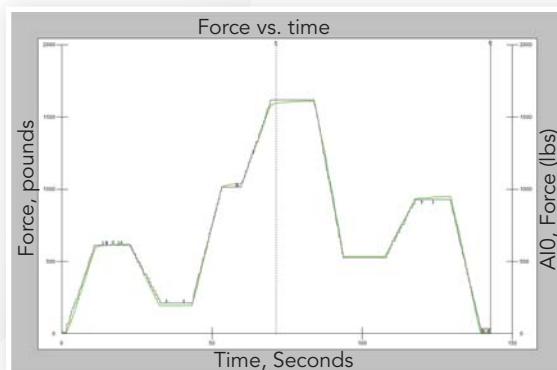
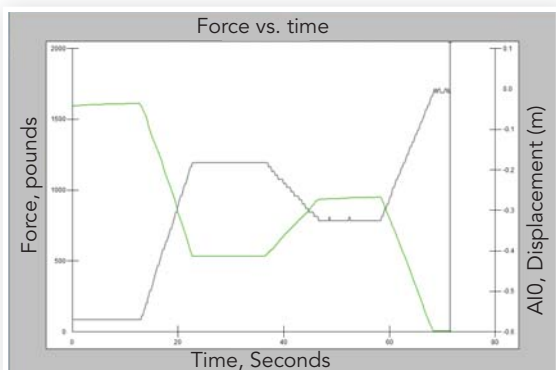

High Speed Data without Synchronization

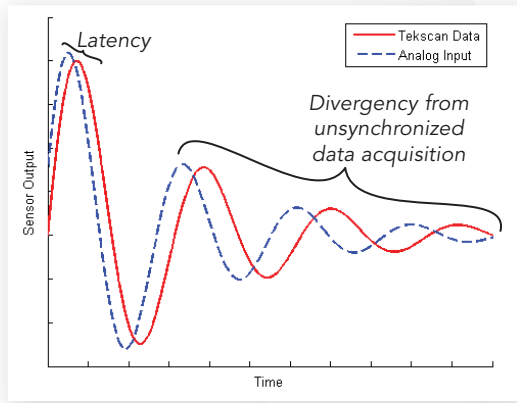

High Speed Data with Synchronization

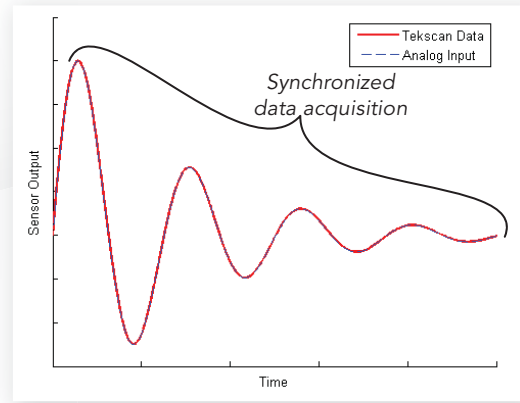

Analog Input Module Specs

Model #	USB-6008	USB-6210
General		
USB Power	Bus-Powered	Bus-Powered
Measurement Type	Voltage	Voltage
Isolation Type	None	None
Input/Output		
Analog Channels	8*	8
Resolution	12-bits	16-bits
Sample Rate	Same as Tekscan Sensor (not synch, 100 Hz max)	Same as Tekscan Sensor (synch, 20 kHz max)
Max Voltage	10 V	10 V
Voltage Input Range	-10 V to 10 V	-10 V to 10 V
Synchronize Port Input	N/A	1
Physical Specifications		
Length	8.51 cm (3.35 in.)	16.9 cm (6.65 in.)
Width	8.18 cm (3.22 in.)	9.4 cm (3.70 in.)
Height	2.31 cm (0.91 in.)	3.1 cm (1.20 in.)
I/O Connector	Screw Terminals	Screw Terminals
Cable compatibility	16 to 28 AWG	16 to 28 AWG
Weight	84 g (3 oz)	206 g (7.02 oz)
Operating Temperature	0° to 55°C (32° to 131°F)	0° to 45°C (32° to 113°F)
Storage Temperature	-40° to 85°C (-40° to 185°F)	-20° to 70°C (-4° to 158°F)
Humidity	5 to 90% RH, non-condensing	10 to 90% RH, non-condensing
System Requirements		
Software	I-Scan V7.5 or Newer	I-Scan V7.6 or Newer
Operating System	Windows XP, Vista, 7 & 8, 32 or 64-bit	Windows XP, Vista, 7 & 8, 32 or 64-bit
Software	Trigger for Evolution: Yes (Trigger Add-On) Analog Input: No additional software needed.	Analog Input: Yes (Trigger Add-On)
*Analog channel used for triggering can also collect analog data. Voltage threshold for triggering is set during configuration.		

Data Reader Toolkit (DRT)

The Data Reader Toolkit is an Application Programming Interface (API) that is implemented into data analysis applications, including C#, MATLAB, LabView, and VB, to open Tekscan .FSX files. To streamline implementation, the Data Reader Toolkit comes with sample code for functions. Dynamic Link Libraries (DLLs) can be run in Windows XP or newer and are compatible with any language that can use .NET assemblies. This is ideal for users who typically collect large amounts of data, as there is no need to store data in multiple file formats. Users can easily import large amounts of Tekscan pressure data and script a custom analysis to evaluate the data more efficiently.

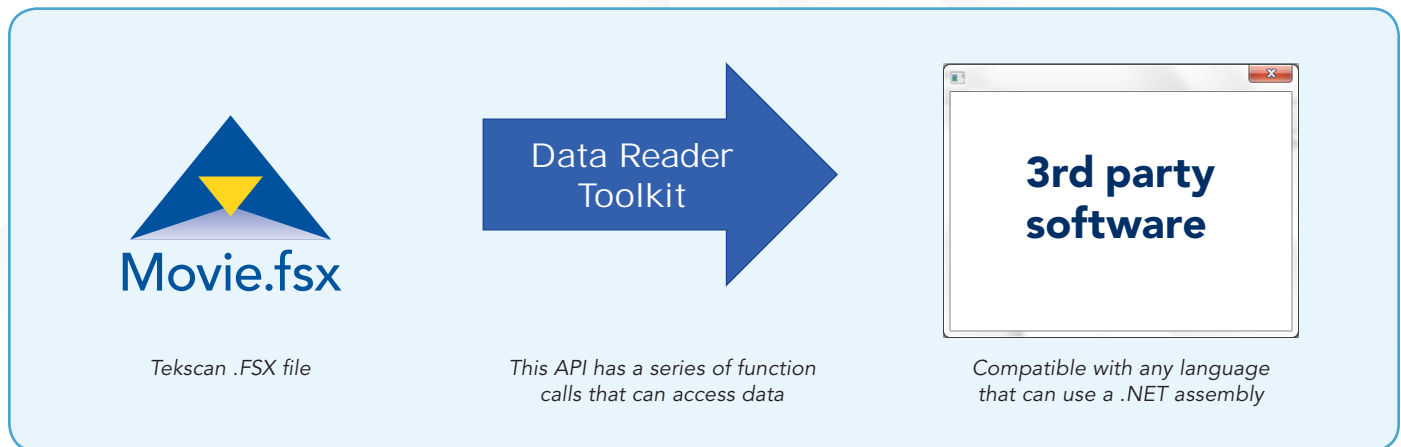

Key Features

- Customize data output and display
- Maintain data in .FSX format
- Customize UI (streamline analysis procedures)
- Run post processing analysis of Tekscan data directly into preferred analysis software

Benefits

- Efficient study of large volume of data files can be scripted into analysis software
- More productivity with simple User Interface customized for repeated procedures
- Streamline analysis of data without having to save multiple file formats
 - Easier to organize and less storage space required
- Create automated analysis for customized applications

Tekscan Pressure Sensor Output in MATLAB

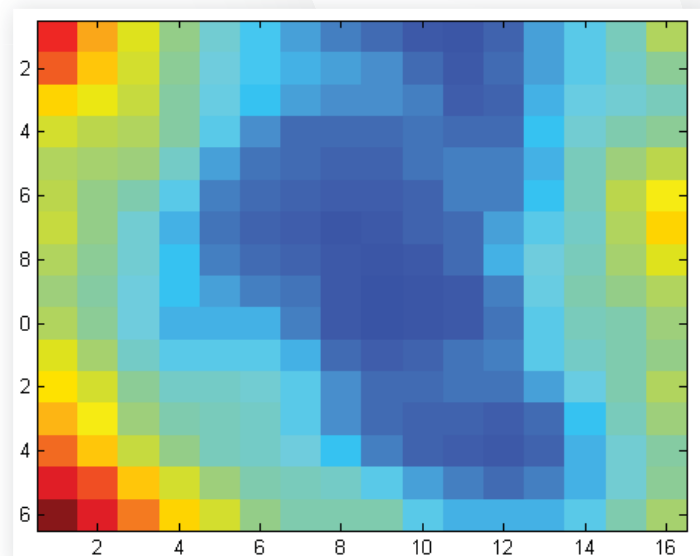

Pressure Mapping Software Development Kit (SDK)

The Pressure Mapping Software Development Kit (SDK) is an Application Programming Interface (API), which allows users to access the functionality of Tekscan's pressure mapping software, giving a developer the ability to program an application that controls and interfaces with Tekscan data acquisition electronics. Tekscan's Pressure Mapping SDK has a set of functions that call on the Dynamic Link Libraries which control data acquisition and analysis. DLLs can be run in Windows XP or newer and are compatible with any language that can use .NET assemblies.

For efficiency, the Pressure Mapping SDK provides sample code for functions in 3rd party applications, including C#, MATLAB, LabVIEW, and VB, to:

- **Get Data** – Communicate with Tekscan data acquisition electronics
- **Record Data** – Control acquisition parameters for saving data
- **Read Data** – Read data from previously saved files

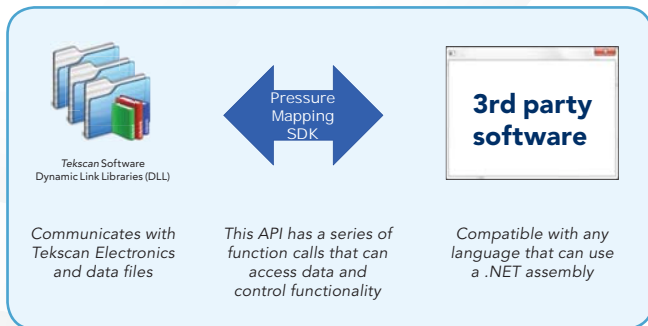

Ideal for monitoring or conducting repeated tests:

- Manufacturing (Quality Control, Test, Machine Setup)
- OEM Product Integration
- Laboratory Research

Key Features

- Customize data output and display
- Customize UI (streamline procedures for operators)
- Integrate pressure mapping with machine functionality
- Standardize measurement devices over multiple facilities
- Collect Tekscan data directly into preferred analysis software

Benefits

- Seamless 3rd party software integration with a pressure mapping sensor
- Increase productivity with simple UI customized for repeated procedures
- Reduce downtime with early fault detection with real-time analysis
- Improve quality with fast, accurate measurement and machine setup
- Analyze data without having to save multiple file formats
- Create automated acquisition and analysis for custom applications

Tekscan Pressure Sensor output in LabVIEW

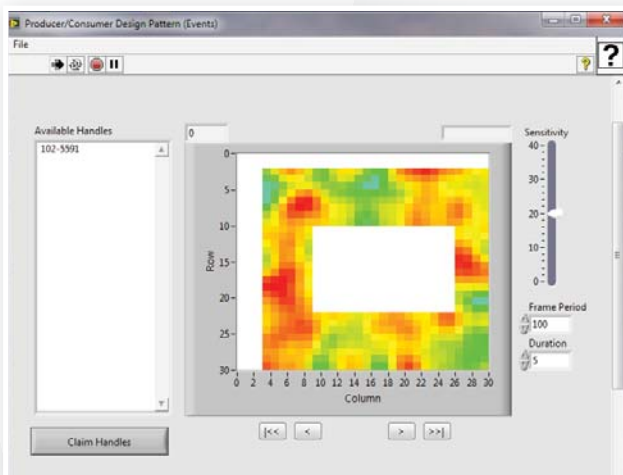

SENSORS

Tekscan matrix-based sensors consist of two thin, flexible polyester sheets that have electrical conductors printed on them in stripe patterns. Typically, the inside surface of one substrate has a row pattern, while the inner surface of the other has columns. The spacing between the stripe patterns (rows and columns) varies according to sensor application, and can be as small as 0.6 mm, or as large as 17 mm. A patented, semi-conductive coating (or ink) is applied over these conductors. When the two polyester sheets are placed on top of each other, a grid pattern is formed. The intersections of the stripes form individual sensing elements. When a force is applied to these sensing elements, the electrical resistance in the ink changes in inverse proportion to the applied normal force. Sensors are less than 0.1 mm thick, and typically have 2,000 sensing elements.

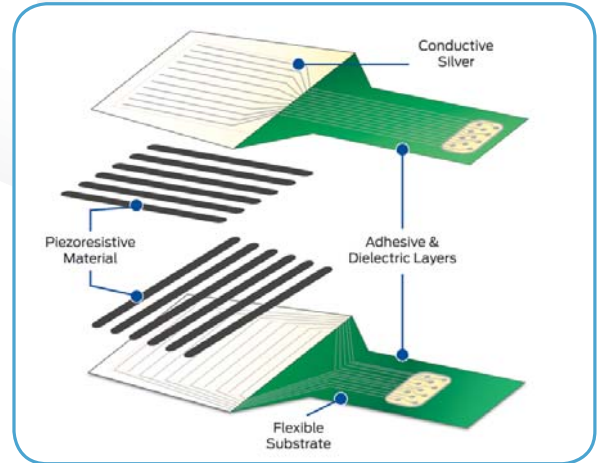

System Performance

Typical system performance is shown below. Resistance of the sensing elements varies inversely with applied load. The system linearizes sensor output into digital counts, or "raw" values, on a scale from 0-255. Calibration converts raw values into engineering units, such as psi or kPa.

Sensor Properties	Standard
Linearity	<± 3%
Repeatability	<± 3.5%
Hysteresis	< 4.5% of full scale
Drift per log time	< 5%
Lag Time	5 μsec
Operating Temperature	-40° to 60°C (-40° to 140°F)
Thickness	0.1 mm (0.004 in.)
Sensing Element Density	Up to 248 per sq. cm (1,600 per sq. in.) Pitch as fine as 0.6 mm (0.025 in.)
Pressure Range	Up to 207 MPa (30,000 psi)

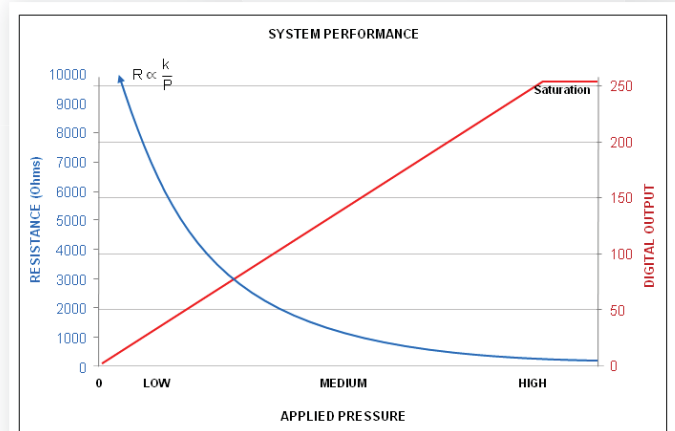

Functionality

Sophisticated, microprocessor based circuitry controls scanning sequence and frequency, adjusts sensitivity, and optimizes the performance of matrix-based sensors. The image shows the sensing system and a simplified electrical schematic of the 8 bit electronics (255 levels) that scan the intersecting points of the sensor's rows and columns, measuring the resistance at each sensing element. The sensing elements are read in the presence of multiple contacts while simultaneously limiting the possible current flow through the device. Each sensing element is represented by a variable resistor, whose value is highest when no force is applied to it.

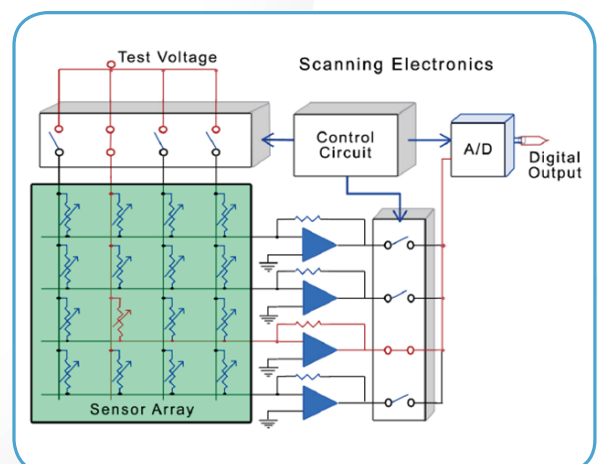

Here are the specifications for I-Scan's most common sensor (model 5101). The same detailed specifications are published for all sensors on our website. For more information and a full listing of Tekscan sensors and specifications, visit tekscan.com/pressureSensors. Please note that a MAP driver is required for every sensor model used with the I-Scan system. The pressure rating of a sensor can be adjusted using the *Sensitivity Adjustment* feature of Tekscan software. The adjustment range varies, depending on electronics (see System Comparison page). For example, Evolution electronics are listed as: x 3 to 1/7 of Sensor Pressure Rating. Therefore, a sensor with a Pressure Rating of 100 PSI can be set to measure 300 PSI max (to cover a higher pressure range) or 14 PSI max (for higher pressure resolution). Any pressure applied to the sensing elements above the max pressure setting will display as a saturated point because this exceeds the specified sensing range.

Specifications

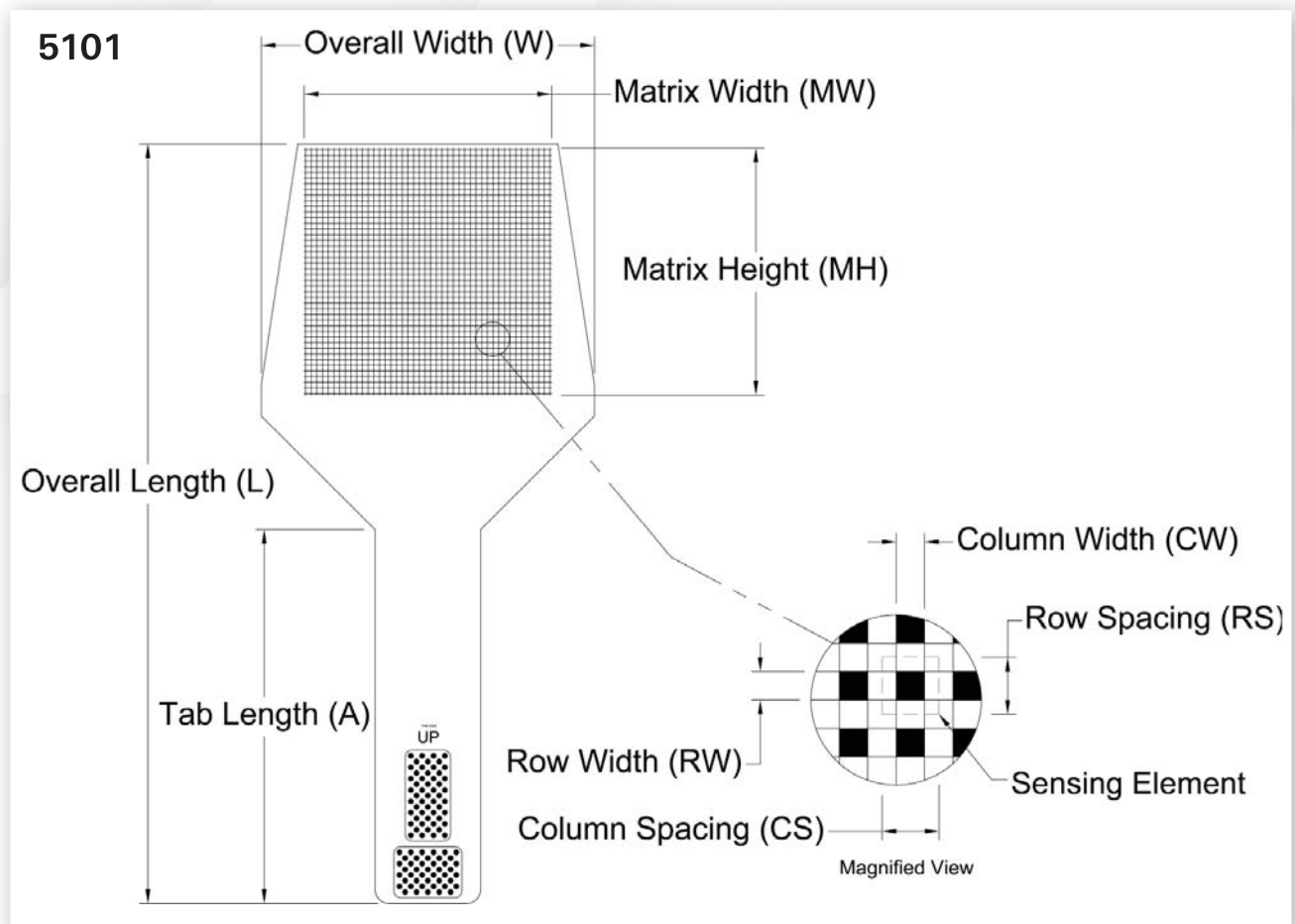

Overall Length L	Overall Width W	Tab Length A	Matrix Width MW	Matrix Height MH	Columns			Rows			Total No. of Sensing Elements	Resolution
					Pitch			Pitch				
					CW	CS	Qty.	RW	RS	Qty.		
13.39 (in.)	5.86 (in.)	6.59 (in.)	4.4 (in.)	4.4 (in.)	0.05 (in.)	0.1 (in.)	44	0.05 (in.)	0.1 (in.)	44	1936	100 (sensing elements per in ²)
340.1 (mm)	148.8 (mm)	167.4 (mm)	111.8 (mm)	111.8 (mm)	1.3 (mm)	2.5 (mm)	44	1.3 (mm)	2.5 (mm)	44	1936	15.5 (sensing elements per cm ²)

Pressure Ratings								
psi	6	10	50	150	350	500	3,000	5,000
kPa	41	69	345	1,034	2,413	3,448	20,685	34,475

EQUILIBRATION DEVICES

Equilibration devices are recommended for improving accuracy and lifespan of Tekscan systems. During equilibration, the sensor is inserted between a flat backing plate and an air filled bladder, which is inflated in order to apply a uniform pressure to the active area of the sensor. The equilibration process allows the software to compensate for any variation or uneven output across individual sensing elements, caused by manufacturing or repeated use of the sensor. Equilibration devices are useful to perform quality assurance checks on the sensor, and confirm uniform output by the sensor.



Why Equilibration?

Over time and through repeated loading, individual force sensing elements will eventually start to vary somewhat in sensitivity. The equilibrator applies a uniform pressure across the face of the sensor, allowing the software to easily see and quantify these variations. A digital compensation factor is automatically created and applied to each individual sensing element. This normalizes all of the sensing elements on the sheet; improving the accuracy and extending the lifespan of the sensor.

Equilibration devices are available for various pressure ranges. Some units require external compressed air to generate pressure in the bladder, while others have self contained sources. See Pressure Source for desired equilibrator in tables below.

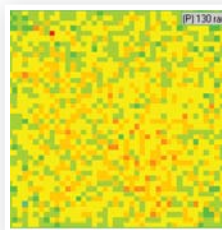
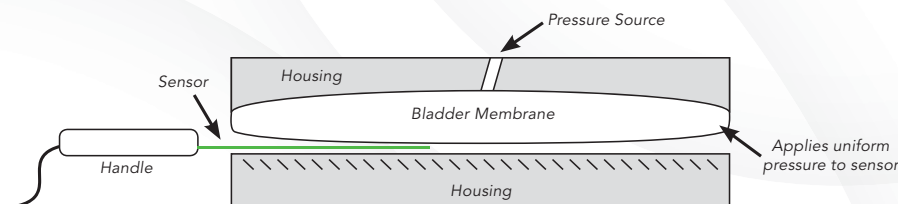

Sensor in Equilibrator before software equilibration is performed

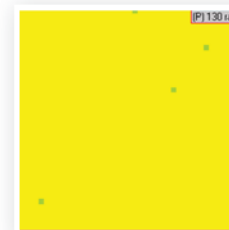

Sensor in Equilibrator after software equilibration is performed

Low Pressure: 0-5 psi (0-34.5 kPa)		
Model	Active Area	Pressure Source
PB5A	114 mm x 318 mm (4.5 in. x 12.5 in.)	Pneumatic (self contained w/ weights)
PB5C	445 mm x 495 mm (17.5 in. x 19.5 in.)	Pneumatic (self contained w/ weights)
0-15 psi (0-103 kPa)		
PB15A	445 mm x 495 mm (17.5 in. x 19.5 in.)	Pneumatic (compressed air)
PB15C	114 mm x 311 mm (4.5 in. x 12.3 in.)	Pneumatic (compressed air)

Medium Pressure: 0-100 psi (0-689 kPa)		
Model	Active Area	Pressure Source
PB100C	330 mm x 495 mm (13.0 in. x 19.5 in.)	Pneumatic (compressed air)
PB100E	127 mm x 311 mm (5.0 in. x 12.3 in.)	Pneumatic (compressed air)
PB100F	572 mm x 521 mm (22.5 in. x 20.5 in.)	Pneumatic (compressed air)
PB100H	445 mm x 495 mm (17.5 in. x 19.5 in.)	Pneumatic (compressed air)

High Pressure: 0-500 psi (0-3447 kPa)		
Model	Active Area	Pressure Source
PB500C	143 mm x 152 mm (5.625 in. x 6.0 in.)	Hydraulic

EQUILIBRATOR	Low Pressure				Medium Pressure					High Pressure
	PB5A	PB5C	PB15A	PB15C	PB100C	PB100E	PB100F-1	PB100H	PB100N	PB500C
SENSOR MODEL										
3000	S	X	X	X	X	S	X	X	X	
3001	S	X	X	X	X	S	X	X	X	
3150		S	X				X	X	X	
4000	S	X	X	X	X	S	X	X	X	S
4011	S	X	X	X	X	S	X	X	X	S
4041	S	X	X	X	X	S	X	X	X	S
4201	S	X	X	X	X	S	X	X	X	S
4205	S	X	X	X	X	S	X	X	X	S
4256	S	X	X		S		X	X	X	S
4400	S	X	X	X	X	S	X	X	X	S
4402	S	X	X	X	X	S	X	X	X	S
5026	S	X	X	X	X	S	X	X	X	S
5027	S	X	X	X	X	S	X	X	X	S
5033	S	X	X	X	X	S	X	X	X	S
5040	S	X	X	X	X	S	X	X	X	S
5051	S	X	X	S	X	S	X	X	X	S
5076	S	X	X	X	X	S	X	X	X	S
5101		S	X		S		X	X	X	S
5151		S	X		S		X	X	X	
5250		X	S		S		X	X	X	
5260		S	X		S		X	X	X	
5270		S	X				X	S	X	
5315		S	X				X	S	X	
5320		S	X		S		X	X	X	
5330							S		X	
5350		S	X				X	S	X	
5400N									S	
5501		S	X		S		X	X	X	
5511		S	X		S		X	X	X	
5515		S	X		S		X	X	X	
5526		S	X		S		X	X	X	
5555		X	S		S		X	X	X	
5570	S	X	X	X	X	S	X	X	X	
5620N		X	X		S		X	X	X	
5630N	S	X	X	X	X	S	X	X	X	S
5800	S	X	X	X	X	S	X	X	X	S
6010N		S	X				X	S	X	
6077	S	X	X	X	X	S	X	X	X	S
6220	S	X	X	X	X	S	X	X	X	S
6230	S	X	X	X	X	S	X	X	X	S
6300	S	X	X	X	S				X	
6501					S					S
6900	S	X	X	X	X	S	X	X	X	S
7101							X	S	X	
7200N									S	
7501	S	X	X	X	X	S	X	X	X	S
8001		S	X		S		X	X	X	
8100	S	X	X	X	X	S	X	X	X	S
8110	S	X	X	X	X	S	X	X	X	
8150		S	X		S		X	X	X	
8155							X		S	
9500	S	X	X	X	X	S	X	X	X	S
9550	S	X	X	X	X	S	X	X	X	S
9801	S	X	X	X	X	S	X	X	X	
9830		S	X		S		X	X	X	
9850	S	X	X	X	S		X	X	X	S
9851	S	X	X	X	S		X	X	X	
9855N	S	X	X	X	X	S	X	X	X	S
9857N	S	X	X	X	S		X	X	X	S

S – Standard Equilibrator for this sensor X – Other Equilibrators that are compatible with this sensor

CONTACT INFORMATION

Our engineers have extensive application knowledge and experience. We are readily available to handle your application needs or answer any questions.

Inside Sales Engineer – Pressure Mapping Division:

+1.617.464.4282
info@tekscan.com

Main Contact Information:

Tekscan, Inc.
307 West First Street, South Boston, MA 02127
+1.617.464.4500 • Toll Free 800.248.3669 • Fax +1.617.464.4266
info@tekscan.com • www.tekscan.com/pm



Tekscan™



+1.617.464.4282



1.800.248.3669



info@tekscan.com



www.tekscan.com/pm